

THE TRANSCEIVER
IC-7800
Instruction Manual

FOREWORD

Congratulations! You are the owner of the world's most advanced amateur HF/50 MHz transceiver— IC-7800. The IC-7800 is designed and built with Icom's superior technology and craftsmanship. With proper care, this product should provide you with years of trouble-free operation.

We would like to take a few moments of your time to thank you for making the IC-7800 your radio of choice, and hope you agree with Icom's philosophy of "technology first." Many hours of research and development went into the design of your IC-7800.

◇ **FEATURES**

- *Ultimate receiver performance: third-order intercept (IP3) of +40 dBm (HF bands only), both main and sub*
- *Independent identical receiver circuits for main and sub bands provide perfect no-compromise Dualwatch operation*
- *Built-in Baudot RTTY and PSK31 modulator/demodulator and direct PC keyboard connection capability for RTTY and PSK31 operation without a PC*
- *Upgraded real-time spectrum scope— center frequency and fix frequency modes, plus mini-scope displays*

IMPORTANT

READ THIS INSTRUCTION MANUAL CAREFULLY before attempting to operate the transceiver.

SAVE THIS INSTRUCTION MANUAL. This manual contains important safety and operating instructions for the IC-7800.

EXPLICIT DEFINITIONS

WORD	DEFINITION
⚠ WARNING	Personal injury, fire hazard or electric shock may occur.
CAUTION	Equipment damage may occur.
NOTE	If disregarded, inconvenience only. No risk of personal injury, fire or electric shock.

TRADEMARKS

Icom, Icom Inc. and the  logo are registered trademarks of Icom Incorporated (Japan) in the United States, the United Kingdom, Germany, France, Spain, Russia and/or other countries.

PRECAUTIONS

⚠ **WARNING HIGH RF VOLTAGE! NEVER** attach an antenna or internal antenna connector during transmission. This may result in an electrical shock or burn.

⚠ **WARNING! NEVER** operate the transceiver with a headset or other audio accessories at high volume levels. Hearing experts advise against continuous high volume operation. If you experience a ringing in your ears, reduce the volume or discontinue use.

⚠ **CAUTION! NEVER** change the internal settings of the transceiver. This may reduce transceiver performance and/or damage to the transceiver.

In particular, incorrect settings for transmitter circuits, such as output power, idling current, etc., might damage the expensive final devices.

The transceiver warranty does not cover any problems caused by unauthorized internal adjustment.

⚠ **CAUTION! NEVER** touch the transceiver top cover when transmitting continuously for long periods. The top cover may be hot.

⚠ **CAUTION!** The transceiver weighs approx. 25 kg (55 lb). Always have two people available to carry, lift or turn over the transceiver.

⚠ **CAUTION!** The line-voltage receptacle must be near the transceiver and must be easily accessible. Avoid extension cords.

⚠ **ACHTUNG!** Die Steckdose muß nahe bei diesem Gerät angebracht und zugänglich sein.

⚠ **NEVER** let metal, wire or other objects protrude into the transceiver or into connectors on the rear panel. This may result in an electric shock.

⚠ **NEVER** block any cooling vents on the top, rear or bottom of the transceiver.

⚠ **NEVER** expose the transceiver to rain, snow or any liquids.

⚠ **NEVER** install the transceiver in a place without adequate ventilation. Heat dissipation may be reduced, and the transceiver may be damaged.

⚠ **NEVER** operate or touch the transceiver with wet hands. This may result in an electric shock or damage to the transceiver.

DO NOT use chemical agents such as benzine or alcohol when cleaning the IC-7800, as they can damage the transceiver's surfaces.

DO NOT push the PTT switch when you don't actually desire to transmit.

AVOID using or storing the transceiver in areas with temperatures below $\pm 0^{\circ}\text{C}$ ($+32^{\circ}\text{F}$) or above $+50^{\circ}\text{C}$ ($+122^{\circ}\text{F}$).

AVOID placing the transceiver in excessively dusty environments or in direct sunlight.

AVOID placing the transceiver against walls or putting anything on top of the transceiver. This may overheat the transceiver.

Always place unit in a secure place to avoid inadvertent use by children.

BE CAREFUL! If you use a linear amplifier, set the transceiver's RF output power to less than the linear amplifier's maximum input level, otherwise, the linear amplifier will be damaged.

Use Icom microphones only (supplied or optional). Other manufacturers' microphones have different pin assignments, and connection to the IC-7800 may damage the transceiver or microphone.

The LCD display may have cosmetic imperfections that appear as small dark or light spots. This is not a malfunction or defect, but a normal characteristic of LCD displays.

During maritime mobile operation, keep the transceiver and microphone as far away as possible from the magnetic navigation compass to prevent erroneous indications.

Turn [I/O] switch (on the rear panel) OFF and/or disconnect the AC power cable from the AC outlet when you will not use the transceiver for long period of time.

For U.S.A. only

CAUTION: Changes or modifications to this device, not expressly approved by Icom Inc., could void your authority to operate this device under FCC regulations.

SUPPLIED ACCESSORIES

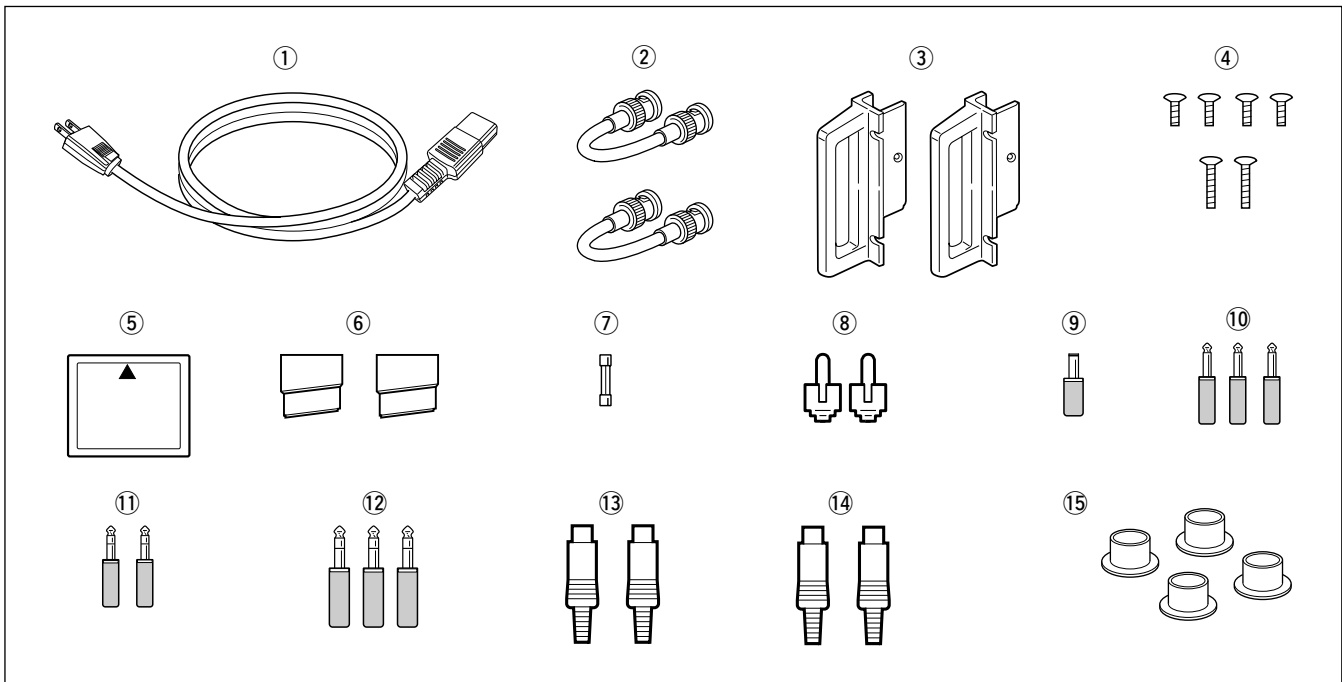

① AC power cable*	1	⑨ DC power plug	1
② Antenna jumper cables	2	⑩ 2-conductor 1/8" plugs	3
③ Rack mounting handles	1 pair	⑪ 3-conductor 1/8" plugs	2
④ Screws for rack mounting handles	1 set	⑫ 3-conductor 1/4" plugs	3
⑤ CF (Compact Flash) memory card	1	⑬ ACC plugs (7-pin)	2
⑥ Stands	1 pair	⑭ ACC plugs (8-pin)	2
⑦ Spare fuse (FGB 2 A)	1	⑮ Antenna connector caps	4
⑧ RCA plugs	2		

*May differ from that shown according to version

TABLE OF CONTENTS

Section 1 PANEL DESCRIPTION

■ Front panel	1-2
■ Rear panel	1-12
■ LCD display	1-14
■ Screen menu arrangement	1-15

Section 2 INSTALLATION AND CONNECTIONS

■ Unpacking	2-2
■ Antenna jumper cable connection	2-2
■ Selecting a location	2-2
■ Rack mounting handle attachment	2-2
■ Grounding	2-3
■ Antenna connection	2-3
■ CF (Compact Flash) memory card	2-3
■ Required connections	2-4
◇ Front panel	2-4
◇ Rear panel	2-4
■ Advanced connections	2-5
◇ Front panel	2-5
◇ Rear panel—1	2-5

TABLE OF CONTENTS

	◇ Rear panel—2	2-6
■	Linear amplifier connections	2-7
	◇ Connecting the IC-PW1/EURO	2-7
	◇ Connecting a non-Icom linear amplifier	2-7
■	Transverter jack information	2-8
■	FSK and AFSK (SSTV) connections	2-8
■	Microphone connector information	2-9
■	Microphones (options)	2-9
	◇ SM-20	2-9
	◇ HM-36	2-9
■	Accessory connector information	2-10
Section 3	BASIC OPERATIONS	
■	When first applying power (CPU resetting)	3-2
■	Initial settings	3-2
■	Main/Sub band selection	3-3
■	Selecting VFO/memory mode	3-3
■	Selecting an operating band	3-4
	◇ Using the band stacking registers	3-4
■	Frequency setting	3-5
	◇ Tuning with the main dial	3-5
	◇ Direct frequency entry with the keypad	3-5
	◇ Quick tuning step	3-6
	◇ Selecting “kHz” step	3-6
	◇ 1/4 tuning step function	3-6
	◇ Selecting 1 Hz step	3-7
	◇ Auto tuning step function	3-7
	◇ Band edge warning beep	3-7
■	Operating mode selection	3-8
■	Volume setting	3-9
■	RF gain adjustment	3-9
■	Squelch level adjustment	3-9
■	Meter indication selection	3-10
	◇ Multi-function digital meter	3-10
	◇ Meter type selection	3-11
■	Basic transmit operation	3-12
	◇ Transmitting	3-12
	◇ Microphone gain adjustment	3-12
	◇ Drive gain adjustment	3-13
Section 4	RECEIVE AND TRANSMIT	
■	Operating SSB	4-2
	◇ Convenient functions for receive	4-2
	◇ Convenient functions for transmit	4-3
	◇ About 5 MHz band operation (USA version only)	4-3
■	Operating CW	4-4
	◇ Convenient functions for receive	4-4
	◇ Convenient functions for transmit	4-5
	◇ About CW reverse mode	4-5
	◇ About CW pitch control	4-5
	◇ CW side tone function	4-5
	◇ APF (Audio Peak Filter) operation	4-6
	◇ About 137 kHz band operation (Europe, UK, Italy, Spain, France versions only)	4-6
■	Electronic keyer functions	4-7

TABLE OF CONTENTS

- ◇ Memory keyer screen4-8
- ◇ Editing a memory keyer4-9
- ◇ Contest number set mode4-10
- ◇ Keyer set mode4-11
- Operating RTTY (FSK) 4-13
 - ◇ Convenient functions for receive4-14
 - ◇ About RTTY reverse mode4-14
 - ◇ Twin peak filter4-14
 - ◇ Functions for the RTTY decoder indication4-15
 - ◇ Setting the decoder threshold level4-15
 - ◇ RTTY memory transmission4-16
 - ◇ Automatic transmission/reception setting4-16
 - ◇ Editing RTTY memory4-17
 - ◇ RTTY decode set mode4-18
 - ◇ Data saving4-20
- Operating PSK 4-21
 - ◇ Convenient functions for receive4-22
 - ◇ About BPSK and QPSK mode4-22
 - ◇ Functions for the PSK decoder indication4-23
 - ◇ Setting the decoder threshold level4-23
 - ◇ PSK memory transmission4-24
 - ◇ Automatic transmission/reception setting4-24
 - ◇ Editing PSK memory4-25
 - ◇ PSK decode set mode4-26
 - ◇ Data saving4-28
- Operating AM 4-29
 - ◇ Convenient functions for receive4-29
 - ◇ Convenient functions for transmit4-30
- Operating FM 4-31
 - ◇ Convenient functions for receive4-31
 - ◇ Convenient functions for transmit4-31
- Repeater operation 4-32
 - ◇ Repeater tone frequency setting4-32
- Tone squelch operation 4-33
- Data mode (AFSK) operation 4-34

Section 5 FUNCTIONS FOR RECEIVE

- Spectrum scope screen 5-2
 - ◇ Center mode 5-2
 - ◇ Fix mode 5-3
 - ◇ Mini scope screen indication 5-4
 - ◇ Scope set mode 5-4
- Preamplifier 5-9
- Attenuator 5-9
- RIT function 5-10
 - ◇ RIT monitor function 5-10
- AGC function 5-11
 - ◇ Selecting the preset value 5-11
 - ◇ Adjusting the AGC time constant 5-11
 - ◇ Setting the AGC time constant preset value 5-11
- Twin PBT operation 5-12
- IF filter selection 5-13
 - ◇ IF filter selection 5-13
 - ◇ Filter passband width setting (except FM mode) 5-13
 - ◇ Roofing filter selection 5-14

TABLE OF CONTENTS

	◇ DSP filter shape	5-14
	◇ Filter shape set mode	5-14
	■ Dualwatch operation	5-16
	■ Noise blanker	5-17
	◇ NB set mode	5-17
	■ Noise reduction	5-18
	■ Dial lock function	5-18
	■ Notch function	5-19
	■ Digital selector	5-19
Section 6	FUNCTIONS FOR TRANSMIT	
	■ VOX function	6-2
	◇ Using the VOX function	6-2
	◇ Adjusting the VOX function	6-2
	◇ VOX set mode	6-2
	■ Break-in function	6-3
	◇ Semi break-in operation	6-3
	◇ Full break-in operation	6-3
	■ ΔTX function	6-4
	◇ ΔTX monitor function	6-4
	■ Monitor function	6-4
	■ Transmit filter width setting (SSB only)	6-5
	■ Speech compressor (SSB only)	6-5
	■ Split frequency operation	6-6
	■ Quick split function	6-7
	◇ Split lock function	6-7
Section 7	VOICE RECORDER FUNCTIONS	
	■ About digital voice recorder	7-2
	■ Recording a received audio	7-3
	◇ Basic recording	7-3
	◇ One-touch recording	7-3
	■ Playing the recorded audio	7-4
	◇ Basic playing	7-4
	◇ One-touch playing	7-4
	■ Protect the recorded contents	7-5
	■ Erasing the recorded contents	7-5
	■ Recording a message for transmit	7-6
	◇ Recording	7-6
	◇ Confirming a message for transmit	7-6
	■ Programming a memory name	7-7
	■ Sending a recorded message	7-8
	◇ Transmit level setting	7-8
	■ Voice set mode	7-9
	■ Saving a voice memory into the CF card	7-10
	◇ Saving the received audio memory	7-10
	◇ Saving the TX memory	7-10
Section 8	MEMORY OPERATION	
	■ Memory channels	8-2
	■ Memory channel selection	8-2
	◇ Using the [▲]/[▼] keys	8-2
	◇ Using the keypad	8-2
	■ Memory list screen	8-3
	◇ Selecting a memory channel using the memory list screen	8-3
	◇ Confirming programmed memory channels	8-3

TABLE OF CONTENTS

	■ Memory channel programming	8-4
	◇ Programming in VFO mode	8-4
	◇ Programming in memory mode	8-4
	■ Frequency transferring	8-5
	◇ Transferring in VFO mode	8-5
	◇ Transferring in memory mode	8-5
	■ Memory names	8-6
	◇ Editing (programming) memory names	8-6
	■ Memory clearing	8-6
	■ Memo pads	8-7
	◇ Writing frequencies and operating modes into memo pads	8-7
	◇ Calling up a frequency from a memo pad	8-7
Section 9	SCANS	
	■ Scan types	9-2
	■ Preparation	9-2
	■ Voice squelch control function	9-3
	■ Scan set mode	9-3
	■ Programmed scan operation	9-4
	■ Δ F scan operation	9-4
	■ Fine programmed scan/ Δ F scan	9-5
	■ Memory scan operation	9-6
	■ Select memory scan operation	9-6
	■ Setting select memory channels	9-7
	◇ Setting in scan screen	9-7
	◇ Setting in memory list screen	9-7
	◇ Erasing the select scan setting	9-7
	■ Tone scan	9-8
Section 10	ANTENNA TUNER OPERATION	
	■ Antenna connection and selection	10-2
	■ Antenna memory settings	10-3
	◇ Antenna type selection	10-3
	◇ Temporary memory	10-4
	◇ Antenna selection mode	10-4
	■ Antenna tuner operation	10-5
	◇ Tuner operation	10-5
	◇ If the tuner cannot tune the antenna	10-6
Section 11	CLOCK AND TIMERS	
	■ Time set mode	11-2
	■ Daily timer setting	11-3
	■ Setting sleep timer	11-4
	■ Timer operation	11-4
Section 12	SET MODE	
	■ Set mode description	12-2
	◇ Set mode operation	12-2
	◇ Screen arrangement	12-3
	■ Level set mode	12-4
	■ ACC set mode	12-6
	■ Display set mode	12-11
	■ Miscellaneous (Others) set mode	12-14
	■ CF card set menu	12-22
	◇ CF card set screen arrangement	12-22
	◇ Save option set mode	12-23

TABLE OF CONTENTS

◇ Load option set mode	12-24
■ File saving	12-25
■ File loading	12-26
■ Changing the file name	12-27
■ Deleting a file	12-28
■ Formatting the CF card	12-28
Section 13 MAINTENANCE	
■ Troubleshooting	13-2
◇ Transceiver power	13-2
◇ Transmit and receive	13-2
◇ Scanning	13-3
◇ Display	13-3
■ Main dial brake adjustment	13-3
■ Voice synthesizer operation	13-3
■ SWR reading	13-4
■ Screen type and font selections	13-4
■ Frequency calibration (approximate)	13-5
■ Opening the transceiver's case	13-6
■ Clock backup battery replacement	13-6
■ Fuse replacement	13-7
■ Resetting the CPU	13-7
■ About protection indications	13-8
■ Screen saver function	13-8
Section 14 CONTROL COMMAND	
■ Remote jack (CI-V) information	14-2
◇ CI-V connection example	14-2
◇ Data format	14-2
◇ Command table	14-9
◇ To send/read memory contents	14-9
◇ Band stacking register	14-9
◇ Codes for memory keyer contents	14-9
◇ Codes for memory name, opening message and clock 2 name contents	14-9
◇ Offset frequency setting	14-10
◇ Repeater tone/tone squelch frequency setting	14-10
◇ SSB transmission passband width setting	14-10
◇ Color setting	14-10
◇ Bandscope edge frequency setting	14-10
◇ Data mode with filter width setting	14-10
◇ Antenna memory setting	14-10
Section 15 SPECIFICATIONS AND OPTIONS	
■ Specifications	15-2
◇ General	15-2
◇ Transmitter	15-2
◇ Receiver	15-3
◇ Antenna tuner	15-3
■ Options	15-4

TABLE OF CONTENTS

Section 16 UPDATING THE FIRMWARE

■ General	16-2
■ Caution	16-2
■ Preparation	16-3
◇ Firmware and firm utility	16-3
◇ File downloading	16-3
■ Firmware update— CF memory card	16-4
■ Firmware update— PC	16-6
◇ Connections	16-6
◇ IP address setting	16-7
◇ Updating from the PC	16-8

PANEL DESCRIPTION

Section 1

■ Front panel	1-2
■ Rear panel	1-12
■ LCD display	1-14
■ Screen menu arrangement	1-15

1 PANEL DESCRIPTION

■ Front panel

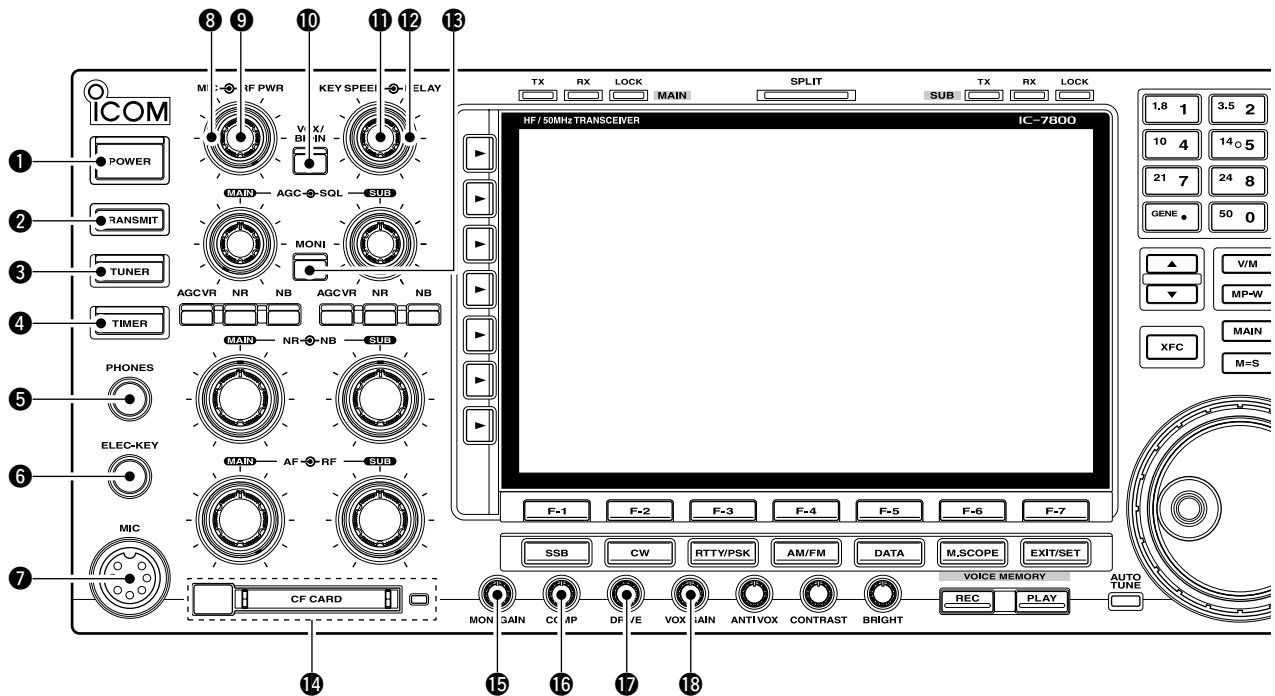

1 POWER SWITCH [POWER] (p. 3-2)

Turn the internal power supply ON in advance. The internal power supply switch is located on the rear panel. (p. 3-2)

- ➔ Push to turn the transceiver power ON.
 - The [POWER] indicator above this switch lights green when powered ON.
- ➔ Push for 1 sec. to turn the transceiver power OFF.
 - The [POWER] indicator lights orange when the transceiver is OFF when the internal power supply is switched ON.

2 TRANSMIT SWITCH [TRANSMIT]

- Selects transmitting or receiving.
- The [TX] indicator lights red while transmitting and the [RX] indicator lights green when the squelch is open.

3 ANTENNA TUNER SWITCH [TUNER] (p. 10-5)

- ➔ Turns the internal antenna tuner ON and OFF (bypass) when pushed momentarily.
 - The [TUNER] indicator above this switch lights green when the tuner is turned ON, goes off when tuner is turned OFF (bypassed).
- ➔ Tunes the antenna tuner manually when pushed for 1 sec.
 - The [TUNER] indicator blinks red during manual tuning.
 - When the tuner cannot tune the antenna, the tuning circuit is bypassed automatically after 20 sec.

4 TIMER SWITCH [TIMER] (p. 11-4)

- ➔ Turns the sleep or daily timer function ON and OFF.
 - The [TIMER] indicator above this switch lights green when the timer is in use.
- ➔ Enters timer set mode when pushed for 1 sec.

5 HEADPHONE JACK [PHONES]

- Accepts standard stereo headphones.
- Output power: 50 mW with an 8 Ω load.
 - When headphones are connected, the internal speaker or connected external speaker does not function.

6 ELECTRONIC KEYS JACK [ELEC-KEY] (p. 2-4)

- Accepts a paddle to activate the internal electronic keyer for CW operation.
- You can select internal electronic keyer, bug-key or straight key operation in keyer set mode. (p. 4-12)
 - A straight key jack is located on the rear panel. See [KEY] on p. 1-13.
 - Keyer polarity (dot and dash) can be reversed in keyer set mode. (p. 4-12)
 - 4-channel memory keyer is available for your convenience. (p. 4-8)

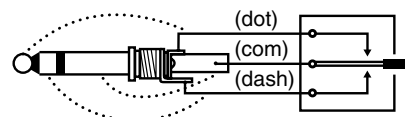

7 MICROPHONE CONNECTOR [MIC]

- Accepts an optional microphone.
- See p. 15-4 for appropriate microphones.
 - See p. 2-9 for microphone connector information.

8 RF POWER CONTROL [RF PWR] (p. 3-12)

Continuously varies the RF output power from minimum (5 W*) to maximum (200 W*).

*AM mode: 5 W to 50 W

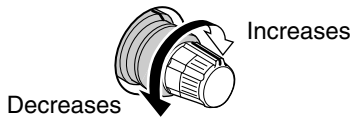

9 MIC GAIN CONTROL [MIC]

Adjusts microphone input gain.

- The transmit audio tone in SSB, AM and FM modes can be adjusted independently in set mode. (p. 12-4)

✓ How to set the microphone gain.

Set the [MIC] control so that the ALC meter sometimes swings during normal voice transmission in SSB, AM or FM mode.

Recommended level for an Icom microphone

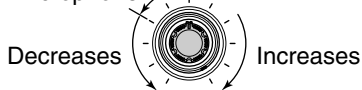

10 VOX/BREAK-IN SWITCH [VOX/BK-IN]

- ➔ Push to turn the VOX function ON and OFF during SSB, AM and FM mode operation. (p. 6-2)
- ➔ Push to turn the break-in function ON (semi-break-in, full-break-in) and OFF during CW mode operation. (p. 6-3)
- ➔ Push for 1 sec. to enter VOX set mode. (p. 6-2)

✓ What is the VOX function?

The VOX function (voice operated transmission) starts transmission without pushing the transmit switch or PTT switch when you speak into the microphone; then, automatically returns to receive when you stop speaking.

✓ What is the break-in function?

The break-in function switches transmit and receive with CW keying. Full break-in (QSK) can monitor the receive signal during keying.

11 ELECTRONIC CW KEYSER SPEED CONTROL [KEY SPEED] (p. 4-4)

Adjusts the internal electronic CW keyer's speed.

- 6 wpm (min.) to 60 wpm (max.) can be set.

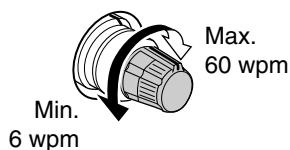

12 BREAK-IN DELAY CONTROL [DELAY] (p. 6-3)

Adjusts the transmit-to-receive switching delay time for CW semi-break-in operations.

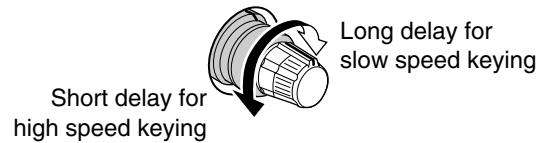

13 MONITOR SWITCH [MONI] (p. 6-4)

Monitors your transmitted IF signal.

- The CW sidetone functions regardless of [MONI] switch setting in CW mode.
- The [MONI] indicator above this switch lights green while the function is activated.

14 MEMORY CARD SLOT [CF CARD] (p. 2-3)

Insert the supplied CF (Compact Flash) memory card for both reading/storing a wide variety of the transceiver's information and data.

- The indicator beside the slot lights or blinks when the transceiver reads or writes to the memory card.
- Push the eject button to remove the memory card.

15 MONITOR GAIN CONTROL [MONI GAIN] (p. 6-4)

Adjusts the transmit IF signal monitor level.

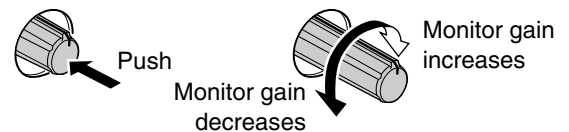

16 COMPRESSION LEVEL CONTROL [COMP]

(p. 6-5)

Adjusts the speech compression level in SSB.

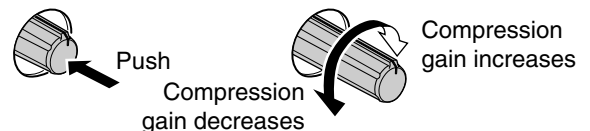

17 DRIVE GAIN CONTROL [DRIVE] (p. 3-13)

Adjusts the transmitter level at the driver stage. Activate in all modes (except SSB with [COMP] OFF).

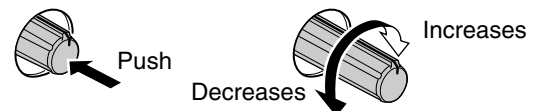

18 VOX GAIN CONTROL [VOX GAIN] (p. 6-2)

Adjusts the transmit/receive switching threshold level for VOX operation.

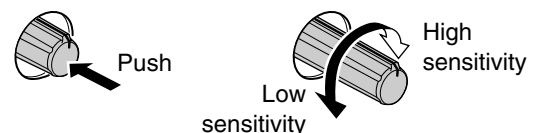

■ Front panel (continued)

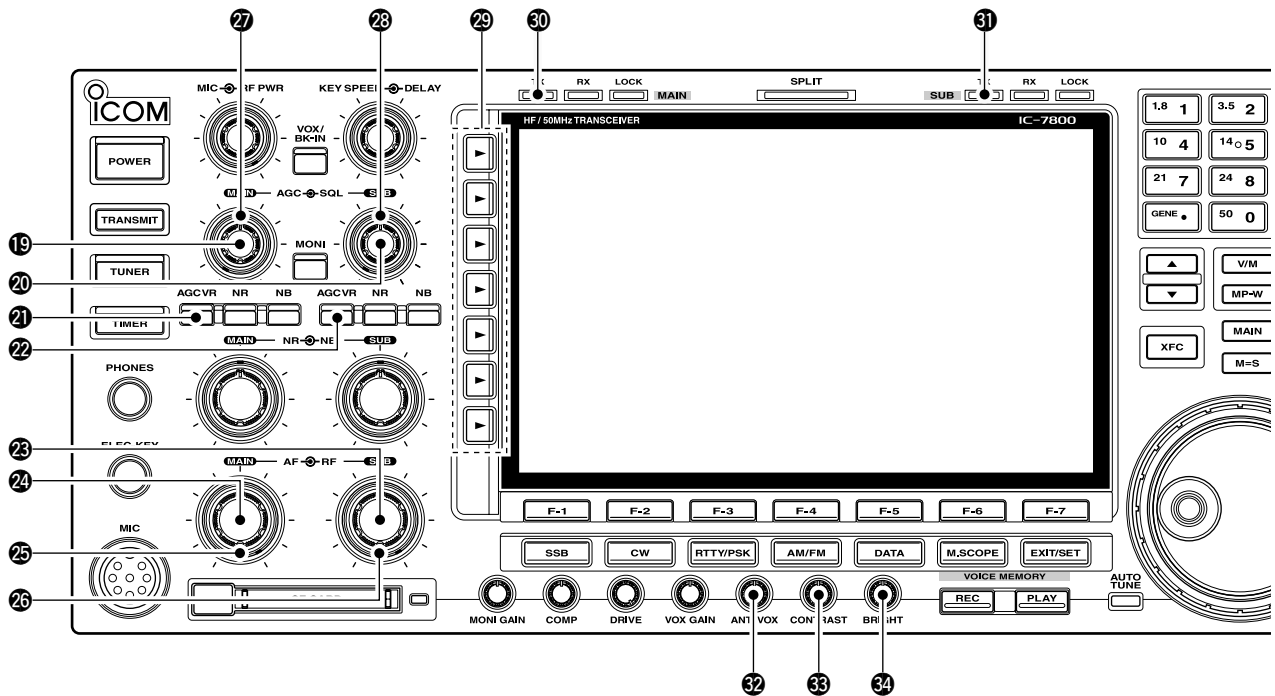

- 19 AGC CONTROL [AGC] (for MAIN band; p. 5-11)
- 20 AGC CONTROL [AGC] (for SUB band; p. 5-11)
Adjusts the continuously-variable AGC circuit time constant.
 - To use [AGC] control, push the appropriate band's [AGC VR] ([AGC VR] indicator lights).



- 25 RF GAIN CONTROL [RF] (outer control; for MAIN band; p. 3-9)
- 26 RF GAIN CONTROL [RF] (outer control; for SUB band; p. 3-9)
Adjusts the RF gain level.
 - ▨ While rotating the RF gain control, you may hear noise. This comes from the DSP unit and does not indicate a malfunction.

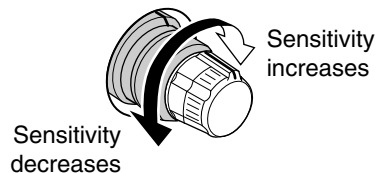

- 21 AGC VOLUME SWITCH [AGC VR] (for MAIN band; p. 5-11)
- 22 AGC VOLUME SWITCH [AGC VR] (for SUB band; p. 5-11)
 - ➔ Push to toggle [AGC] control usage ON and OFF.
 - Use [AGC] control to set the AGC time constant when switched ON.
 - The [AGC VR] indicator above this switch lights green when the control is ON.
 - ➔ Turns the AGC function OFF when pushed for 1 sec.

- 23 AF CONTROL [AF] (inner control; for SUB band)
- 24 AF CONTROL [AF] (inner control; for MAIN band)
Varies the audio output level of the speaker or headphones.

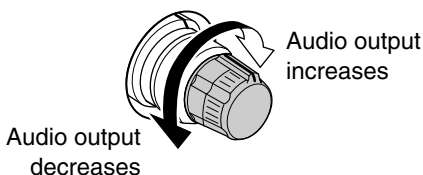

- 27 SQUELCH CONTROL [SQL] (outer control; for MAIN band; p. 3-9)
- 28 SQUELCH CONTROL [SQL] (outer control; for SUB band; p. 3-9)
Adjusts the squelch threshold level. The squelch removes noise output from the speaker (closed condition) when no signal is received.
 - The squelch is particularly effective for FM. It is also available for other modes.
 - 11 to 12 o'clock position is recommended for any setting of the [SQL] control.

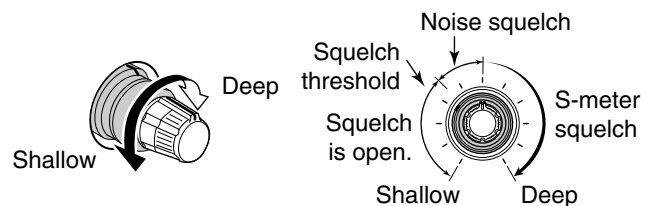

29 MULTI-FUNCTION SWITCHES

Push to select the functions indicated in the LCD display to the right of these switches.

- Functions vary depending on the operating condition.



➔ Selects the antenna connector from ANT1, ANT2, ANT3 and ANT4 when pushed. (p. 10-2)

➔ Displays antenna selection memory when pushed for 1 sec.

- When the receive antenna is activated, the antenna which is connected to [ANT4] is used for receive only.

/// When a transverter is in use, this [ANT] does not function and 'TRV' appears.



➔ Selects RF power (Po), SWR, ALC, COMP, Vd or Id metering during transmit. (p. 3-10)

➔ Switches the multi-function digital meter ON and OFF when pushed for 1 sec. (p. 3-10)



➔ Selects one of 2 receive RF preamps or bypasses them. (p. 5-9)

- "P. AMP1" activates 10 dB preamp.
- "P. AMP2" activates 16 dB high-gain preamp.

✓ What is the preamp?

The preamp amplifies received signals in the front end circuit to improve S/N ratio and sensitivity. Select "P. AMP1" or "P. AMP2" when receiving weak signals.



➔ Selects 6 dB, 12 dB or 18 dB attenuator when pushed. (p. 5-9)

➔ Selects 3 dB, 6 dB, 9 dB, 12 dB, 18 dB, or 21 dB attenuator when pushed for 1 sec. (p. 5-9)

✓ What is the attenuator?

The attenuator prevents a desired signal from distorting when very strong signals are near the desired frequency, or when very strong electric fields, such as from a broadcasting station, are near your location.



➔ Activates and selects fast, middle or slow AGC time constant when pushed. (p. 5-11)

- In FM mode, only "FAST" is available.

➔ Enters the AGC set mode when pushed for 1 sec. (p. 5-11)

/// AGC time constant can be set between 0.1 to 8.0 sec. (depends on mode), or turned OFF. When /// AGC is "OFF," the S-meter does not function.

✓ What is the AGC?

The AGC controls receiver gain to produce a constant audio output level, even when the received signal strength varies dramatically. Select "FAST" for tuning and then select "MID" or "SLOW" depending on the receiving condition.



➔ Turns the speech compressor ON and OFF in SSB mode. (p. 6-5)

➔ Switches the narrow, middle or wide compression when pushed for 1 sec.

✓ What is the speech compressor?

The speech compressor compresses the transmitter audio input to increase the average audio output level, to increase talk power. This function is effective for long-distance communication or when propagation conditions are poor.



➔ Turns the 1/4-speed tuning function ON and OFF in SSB data, CW, RTTY and PSK modes. (p. 3-6)

- 1/4 function sets dial rotation to 1/4 of normal speed for fine tuning.

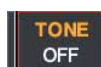

➔ Switches between the tone encoder, tone squelch function and no-tone operation when pushed in FM mode. (pgs. 4-32, 4-33)

➔ Enters the tone set mode when pushed for 1 sec. in FM mode. (pgs. 4-32, 4-33)



➔ Switches the voice squelch control function ON and OFF; useful for scanning. (p. 9-3)

30 TRANSMIT INDICATOR [TX] (for MAIN band)

31 TRANSMIT INDICATOR [TX] (for SUB band)

Lights red while transmitting.

- SUB band's [TX] indicator lights only when in split operation.

32 ANTI VOX CONTROL [ANTI VOX] (p. 6-2)

Adjusts the VOX deactivate level to prevent unwanted VOX activation from the speaker audio.

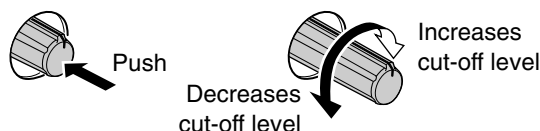

33 LCD CONTRAST CONTROL [CONTRAST]

Adjusts the LCD contrast.

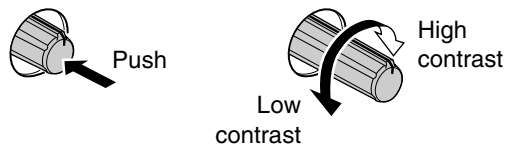

34 LCD BRIGHTNESS CONTROL [BRIGHT]

Adjusts the LCD brightness.



■ Front panel (continued)

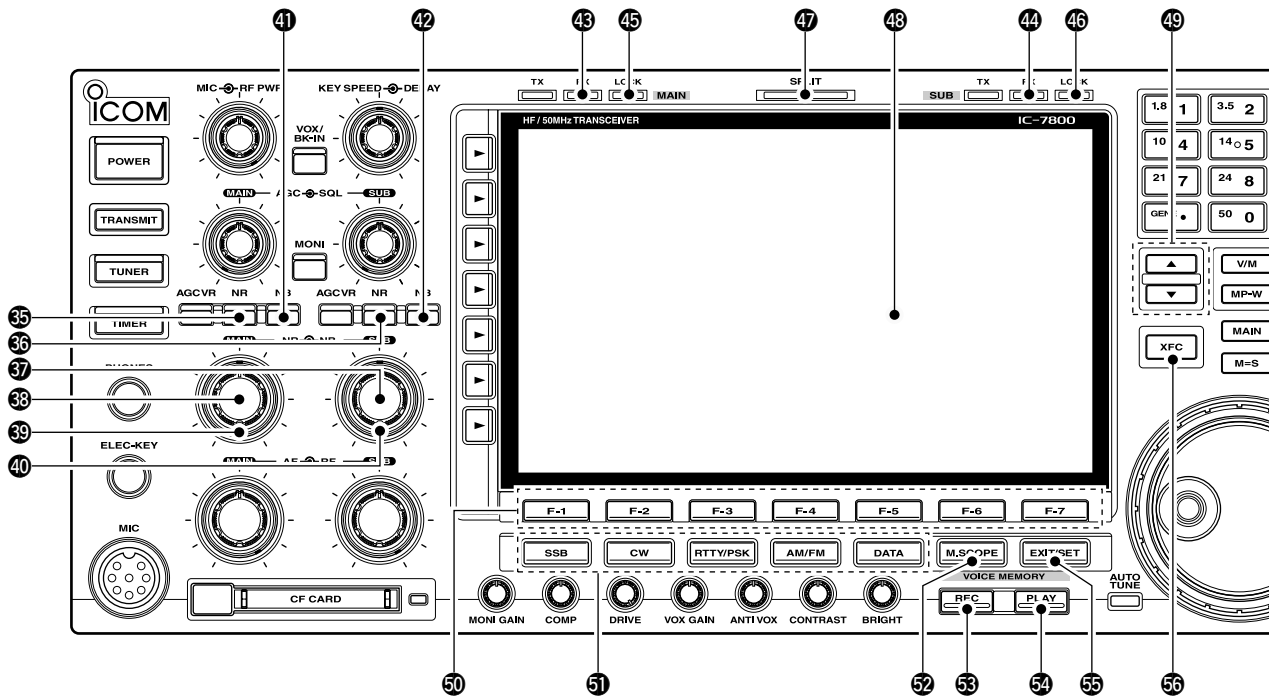

- 35 NOISE REDUCTION SWITCH [NR] (for MAIN band; p. 5-18)
- 36 NOISE REDUCTION SWITCH [NR] (for SUB band; p. 5-18)
Push to switch the DSP noise reduction ON and OFF.
• The [NR] indicator above this switch lights green when the function is activated.
- 37 NOISE REDUCTION LEVEL CONTROL [NR] (inner control; for SUB band; p. 5-18)
- 38 NOISE REDUCTION LEVEL CONTROL [NR] (inner control; for MAIN band; p. 5-18)
Adjusts the DSP noise reduction level when the noise reduction is in use. Set for maximum readability.
• To use this control, push the appropriate band's [NR].
- 39 NOISE BLANKER CONTROL [NB] (outer control; for MAIN band; p. 5-17)
- 40 NOISE BLANKER CONTROL [NB] (outer control; for SUB band; p. 5-17)
Adjust the noise blanker threshold level.
• To use this control, push appropriate band's [NB] switch.

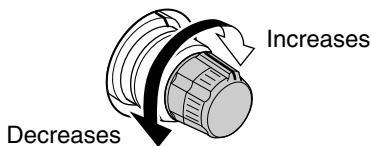

- 41 NOISE BLANKER SWITCH [NB] (for MAIN band; p. 5-17)
- 42 NOISE BLANKER SWITCH [NB] (for SUB band; p. 5-17)
• Switches the noise blanker ON and OFF when pushed. The noise blanker reduces pulse-type noise such as that generated by automobile ignition systems. This function cannot be used for FM, or non-pulse-type noise.
• The [NB] indicator above this switch lights green while the function is activated.
• Enters blank-width set mode when pushed for 1 sec.
- 43 RECEIVE INDICATOR [RX] (for MAIN band)
- 44 RECEIVE INDICATOR [RX] (for SUB band)
Lights green while receiving a signal and when the squelch is open.
- 45 LOCK INDICATOR [LOCK] (for MAIN band; p. 5-18)
- 46 LOCK INDICATOR [LOCK] (for SUB band; p. 5-18)
Lights when the dial lock function is activated.
- 47 SPLIT OPERATION INDICATOR [SPLIT]
Lights during split frequency operation.
- 48 LCD FUNCTION DISPLAY (p. 1-14)
Shows the operating frequency, function switch menus, spectrum scope screen, memory channel screen, set mode settings, etc.

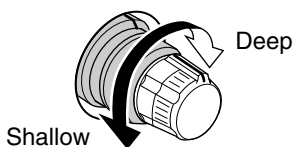



- 49 MEMORY UP/DOWN SWITCHES [▲]/[▼]** (p. 8-2)
Push to select the desired memory channel.
- Memory channels can be selected both in VFO and memory modes.

- 50 LCD FUNCTION SWITCHES [F-1]–[F-7]**
Push to select the function indicated in the LCD display above these switches.
- Functions vary depending on the operating condition.

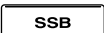
- 51 MODE SWITCHES**
Selects the desired mode. (p. 3-8)
- Announces selected mode via the speech synthesizer. (p. 12-16)

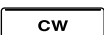
 ➔ Selects USB and LSB modes alternately.

 ➔ Selects CW and CW-R (CW reverse) modes alternately.

 ➔ Switches between RTTY and PSK mode.

➔ Switches RTTY and RTTY-R (RTTY reverse) mode when pushed for 1 sec. in RTTY mode.

➔ Switches PSK and PSK-R (PSK reverse) mode when pushed for 1 sec. in PSK mode.

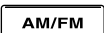
 ➔ Selects AM and FM modes alternately.

 ➔ Selects SSB, AM or FM data mode (USB-D, LSB-D, AM-D, FM-D) when pushed in SSB, AM or FM mode, respectively.

➔ Switches D1, D2 and D3 when pushed for 1 sec.

- 52 MINI SPECTRUM SCOPE SWITCH [M.SCOPE]** (p. 5-4)
Turns the mini spectrum scope screen ON and OFF.
- The mini spectrum scope screen can be displayed with another screen, such as memory or set mode screen, simultaneously.

- 53 VOICE MEMORY RECORD SWITCH [REC]** (p. 7-3)
- ➔ Records the received signal for the preset time period when pushed.
 - After the preset time has passed, stops recording automatically.
 - ➔ Records the received signal until cancelling the record when pushed for 1 sec.
 - Push this switch momentarily to stops recording.
 - The memory records the latest 30 sec. of audio.

- 54 VOICE MEMORY PLAY BACK SWITCH [PLAY]** (p. 7-4)
- ➔ Plays back the previously recorded audio for the preset time period when pushed.
 - ➔ Plays back all of the previously recorded audio when pushed for 1 sec.

- 55 EXIT/SET SWITCH [EXIT/SET]**
- ➔ Push to exit, or return to the previous screen indication during spectrum scope, memory, scan or set mode screen display.
 - ➔ Displays set mode menu screen when pushed for 1 sec.

- 56 TRANSMIT FREQUENCY CHECK SWITCH [XFC]** (p. 6-6)
Monitors the transmit frequency (including Δ TX frequency offset) when pushed and held during split frequency operation.
- While pushing this switch, the transmit frequency can be changed with the main dial, keypad, memo pad or [▲]/[▼] switches.
 - When the split lock function is turned ON, pushing [XFC] cancels the dial lock function. (p. 6-7)

■ Front panel (continued)

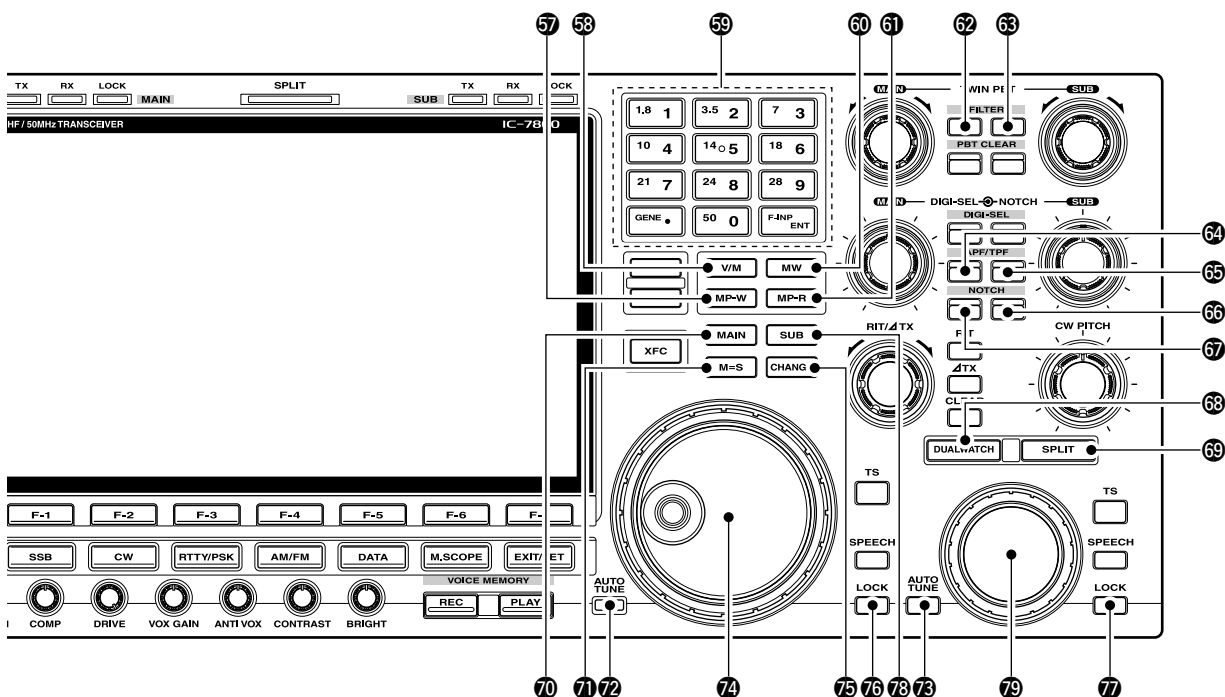

57 MEMO PAD-WRITE SWITCH [MP-W] (p. 8-7)
 Programs the selected readout frequency and operating mode into a memo pad.

- The 5 most recent entries remain in memo pads.
- The memo pad capacity can be expanded from 5 to 10 in set mode. (p. 12-16)

58 VFO/MEMORY SWITCH [V/M]

- Switches the selected readout operating mode between the VFO and memory when pushed. (pgs. 3-3, 8-2)
- Transfers the memory contents to VFO when pushed for 1 sec. (p. 5-5)

59 KEYPAD

- Pushing a key selects the operating band.
 - [GENE•] selects the general coverage band.
- Pushing the same key 2 or 3 times calls up other stacked frequencies in the band. (p. 3-4)
 - Icom's triple band stacking register memorizes 3 frequencies in each band.
- After pushing [F-INP•ENT], enters a frequency or memory channel. Pushing [F-INP•ENT] or [▲/▼] is necessary to end. (pgs. 3-5, 8-2)
 - e.g. to enter 14.195 MHz, push [F-INP] [1.8•1] [10•4] [GENE•] [1.8•1] [28•9] [14•5] [F-INP•ENT].

60 MEMORY WRITE SWITCH [MW] (p. 8-4)
 Stores the selected readout frequency and operating mode into the displayed memory channel when pushed for 1 sec.

- This function is available both in VFO and memory modes.

61 MEMO PAD-READ SWITCH [MP-R] (p. 8-7)
 Each push calls up a frequency and operating mode in a memo pad. The 5 (or 10) most recently programmed frequencies and operating modes can be recalled, starting from the most recent.

- The memo pad capacity can be expanded from 5 to 10 in set mode. (p. 12-16)

62 FILTER SWITCH [FILTER] (for MAIN band; p. 5-13)
63 FILTER SWITCH [FILTER] (for SUB band; p. 5-13)

- Selects one of 3 IF filter settings.
- Enters the filter set screen when pushed for 1 sec.

64 AUDIO PEAK FILTER/TWIN PEAK FILTER SWITCH [APF/TPF] (for MAIN band)
65 AUDIO PEAK FILTER/TWIN PEAK FILTER SWITCH [APF/TPF] (for SUB band)

- Push to turn the audio peak filter ON and OFF during CW mode operation. (p. 4-6)
- Push to turn the twin peak filter ON and OFF during RTTY mode operation. (p. 4-14)
 - "APF" appears when audio peak filter is in use.
 - "TPF" appears when twin peak filter is in use.
- During CW mode operation, push for 1 sec. to select the APF passband width from 80, 160 and 320 Hz. (p. 4-6)

66 NOTCH SWITCH [NOTCH] (for SUB band; p. 5-19)

67 NOTCH SWITCH [NOTCH] (for MAIN band; p. 5-19)

- ➔ Switches the notch function between auto, manual and OFF in SSB and AM modes.
- ➔ Turns the manual notch function ON and OFF when pushed in CW, RTTY and PSK31 mode.
- ➔ Turns the auto notch function ON and OFF when pushed in FM mode.
 - “AN” appears when auto notch is in use.
 - “MN” appears when manual notch is in use.
- ➔ Switches the manual notch characteristics from wide, middle and narrow when pushed for 1 sec.

✓ **What is the notch function?**

The notch function eliminates unwanted CW or AM carrier tones while preserving the desired voice signal. The DSP circuit automatically adjusts the filtering frequency to effectively eliminate unwanted tones.

68 DUALWATCH SWITCH [DUALWATCH] (p. 5-16)

- ➔ Turns the dualwatch function ON and OFF when pushed.
- ➔ Turns the dualwatch function ON and equalizes the main/sub readout frequency to the sub/main readout when pushed for 1 sec. (Quick dualwatch function)
 - The quick dualwatch function can be turned OFF using set mode. (p. 12-14)

69 SPLIT SWITCH [SPLIT] (p. 6-6)

- ➔ Turns the split function ON and OFF when pushed.
- ➔ Turns the split function ON. When pushed for 1 sec. in non-FM modes, equalizes the sub readout frequency to the main readout and sets the sub readout for frequency input. (Quick split function)
 - The offset frequency is shifted from the main readout frequency in FM mode. (p. 12-15)
 - The quick split function can be turned OFF using set mode. (p. 12-15)
- ➔ Turns the split function ON and shifts the sub readout frequency after inputting an offset.

70 MAIN BAND ACCESS SWITCH [MAIN]

- Selects the main readout.
 - The main readout frequency is clearly displayed. The sub readout functions only during split operation or dualwatch.

71 MAIN/SUB EQUALIZING SWITCH [M=S]

- Equalizes the sub readout frequency to the main readout frequency when pushed for 1 sec.

72 AUTOMATIC TUNING SWITCH [AUTO TUNE]
(for MAIN band)

73 AUTOMATIC TUNING SWITCH [AUTO TUNE]
(for SUB band)

- Turns the automatic tuning function ON and OFF in CW and AM modes.

IMPORTANT!

When receiving a weak signal, or receiving a signal with interference, the automatic tuning function may tune the receiver to an undesired signal.

74 MAIN DIAL

- Changes the displayed frequency (main band), selects set mode setting, etc.

75 MAIN/SUB CHANGE SWITCH [CHANGE]

- Switches the frequency and selected memory channel between main and sub readouts when pushed.
 - Switches between transmit frequency and receive frequency when the split frequency function is ON. (p. 6-6)

76 LOCK SWITCH [LOCK] (for MAIN band; p. 5-18)

77 LOCK SWITCH [LOCK] (for SUB band; p. 5-18)
Push to switch the dial lock function ON and OFF.

78 SUB BAND ACCESS SWITCH [SUB]

- Selects the sub readout.
 - The sub readout frequency is clearly displayed. The main readout functions only during split operation or dualwatch.

79 SUB DIAL

- Changes the displayed frequency in sub band.

■ Front panel (continued)

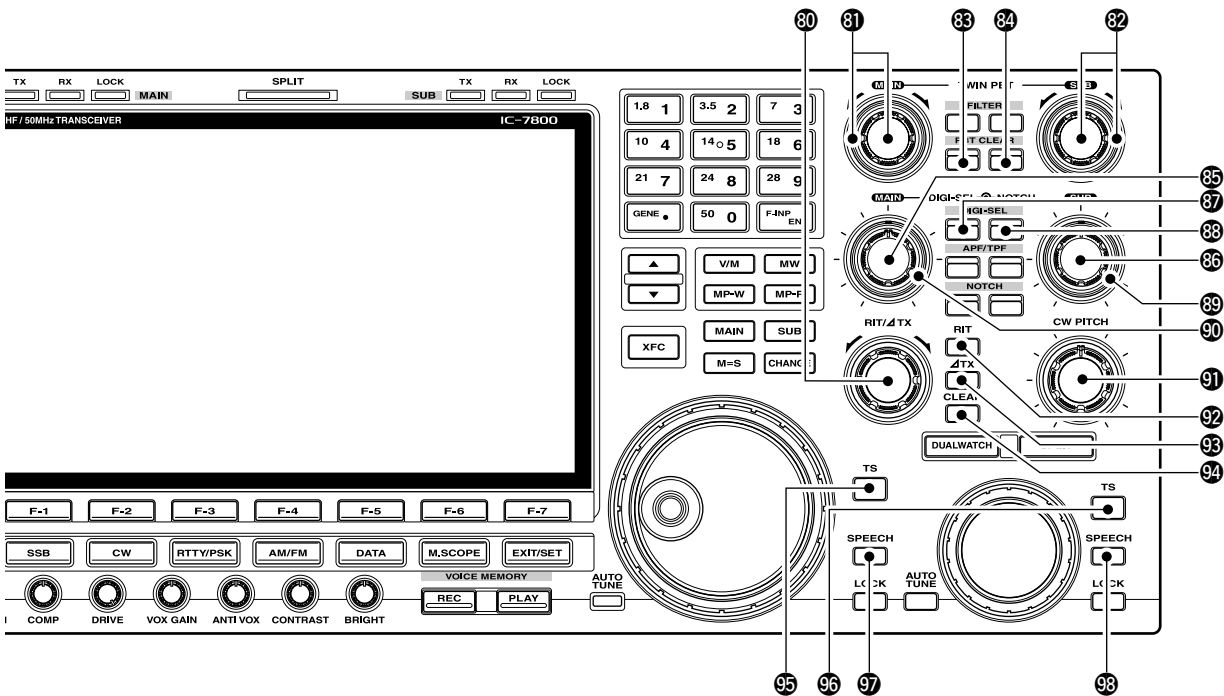

- 80 RIT/ΔTX CONTROL [RIT/ΔTX]** (pgs. 5-10, 6-4)
 Shifts the receive and/or transmit frequency without changing the transmit and/or receive frequency.
- Rotate the control clockwise to increase the frequency, or rotate the control counterclockwise to decrease the frequency. The RIT or ΔTX functions must be ON.
 - The shift frequency range is ±9.999 kHz in 1 Hz steps (or ±9.99 kHz in 10 Hz steps).

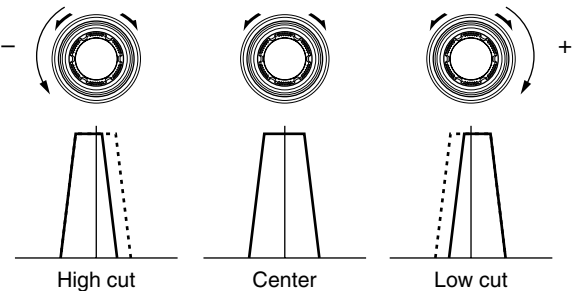
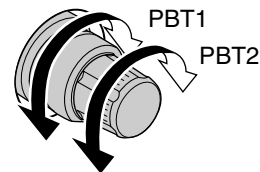
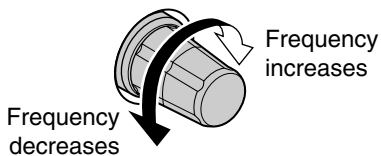

- 81 PASSBAND TUNING CONTROLS [TWIN PBT]**
 (for MAIN band; p. 5-12)

- 82 PASSBAND TUNING CONTROLS [TWIN PBT]**
 (for SUB band; p. 5-12)

- Adjusts the receiver's IF filter "passband width" via the DSP.
- Passband width and shift frequency are displayed in the multi-function display.
 - Push [PBT CLEAR] for 1 sec. to clear the PBT settings.
 - Variable range is set to half of the IF filter passband width. 25 Hz steps and 50 Hz steps are available.

- 83 PBT CLEAR SWITCH [PBT CLEAR]**
 (for MAIN band; p. 5-12)

- 84 PBT CLEAR SWITCH [PBT CLEAR]**
 (for SUB band; p. 5-12)

- Clears the PBT settings when pushed for 1 sec.
- The [PBT CLEAR] indicator above this switch lights when PBT is in use.

✓ **What is the PBT control?**

The PBT function electronically modifies the IF passband width to reject interference. This transceiver uses the DSP circuit for the PBT function.

85 DIGITAL RF SELECTOR CONTROL [DIGI-SEL]
(for MAIN band; p. 5-19)

86 DIGITAL RF SELECTOR CONTROL [DIGI-SEL]
(for SUB band; p. 5-19)

Adjusts the digital RF selector center frequency.
• The control can be reassigned as the audio peak filter adjustment (p. 12-18)

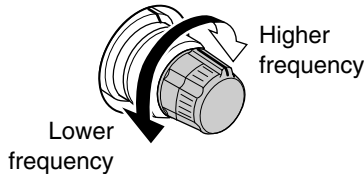

87 DIGITAL RF SELECTOR SWITCH [DIGI-SEL]
(for MAIN band; p. 5-19)

88 DIGITAL RF SELECTOR SWITCH [DIGI-SEL]
(for SUB band; p. 5-19)

Turns the digital RF preselector ON and OFF.
• The [DIGI-SEL] indicator lights green when the preselector is in use.

89 MANUAL NOTCH FILTER CONTROL [NOTCH]
(for SUB band; outer control; p. 5-19)

90 MANUAL NOTCH FILTER CONTROL [NOTCH]
(for MAIN band; outer control; p. 5-19)
Varies the “valley” frequency of the manual notch filter to reject an interfering signal while the manual notch function is ON.

- Notch filter center frequency:
 - SSB : -1060 Hz to 4040 Hz
 - CW : CW pitch freq. + 2540 Hz to CW pitch freq. -2540 Hz
 - AM : -5100 Hz to 5100 Hz

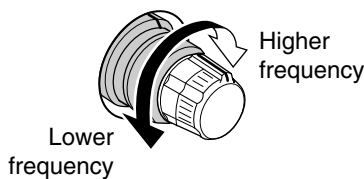

91 CW PITCH CONTROL [CW PITCH] (p. 4-5)
Shifts the received CW audio pitch and the CW side tone pitch without changing the operating frequency.

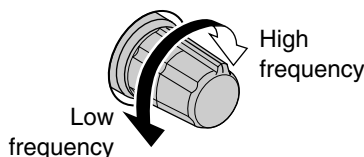

92 RIT SWITCH [RIT] (p. 5-10)
➔ Turns the RIT function ON and OFF when pushed.
• Use [RIT/ΔTX] control to vary the RIT frequency.
➔ Adds the RIT shift frequency to the operating frequency when pushed for 1 sec.

✓ **What is the RIT function?**

Receiver incremental tuning (RIT) shifts the receive frequency without shifting the transmit frequency. This is useful for fine tuning stations calling you on off-frequency or when you prefer to listen to slightly different-sounding voice characteristics, etc.

93 ΔTX SWITCH [ΔTX] (p. 6-4)
➔ Turns the ΔTX function ON and OFF when pushed.
• Use [RIT/ΔTX] control to vary the ΔTX frequency.
➔ Adds the ΔTX shift frequency to the operating frequency when pushed for 1 sec.

✓ **What is the ΔTX function?**

ΔTX shifts the transmit frequency without shifting the receive frequency. This is useful for simple split frequency operation in CW, etc.

94 CLEAR SWITCH [CLEAR] (pgs. 5-10, 6-4)
Clears the RIT/ΔTX shift frequency when pushed for 1 sec. or when pushed momentarily, depending on the quick RIT/ΔTX clear function setting (p. 12-17).

95 QUICK TUNING SWITCH [TS] (for MAIN band)
96 QUICK TUNING SWITCH [TS] (for SUB band)
➔ Turns the quick tuning step ON and OFF. (p. 3-6)
• While the quick tuning indicator, “▼,” is displayed above the frequency indication, the frequency can be changed in programmed kHz steps.
• 0.1, 1, 5, 9, 10, 12.5, 20 and 25 kHz steps are available for each operating mode independently.
➔ When the quick tuning step is OFF, push for 1 sec. to turn the 1 Hz tuning step ON and OFF. (p. 3-7)
➔ When the quick tuning step is ON, push for 1 sec. to enter quick tuning step set mode. (p. 3-6)

97 SPEECH SWITCH [SPEECH]
(for MAIN band; p. 13-3)
98 SPEECH SWITCH [SPEECH]
(for SUB band; p. 13-3)
➔ Push to announce the S-meter indication and the selected readout frequency.
➔ The selected operating mode is additionally announced when pushed for 1 sec.

■ Rear panel

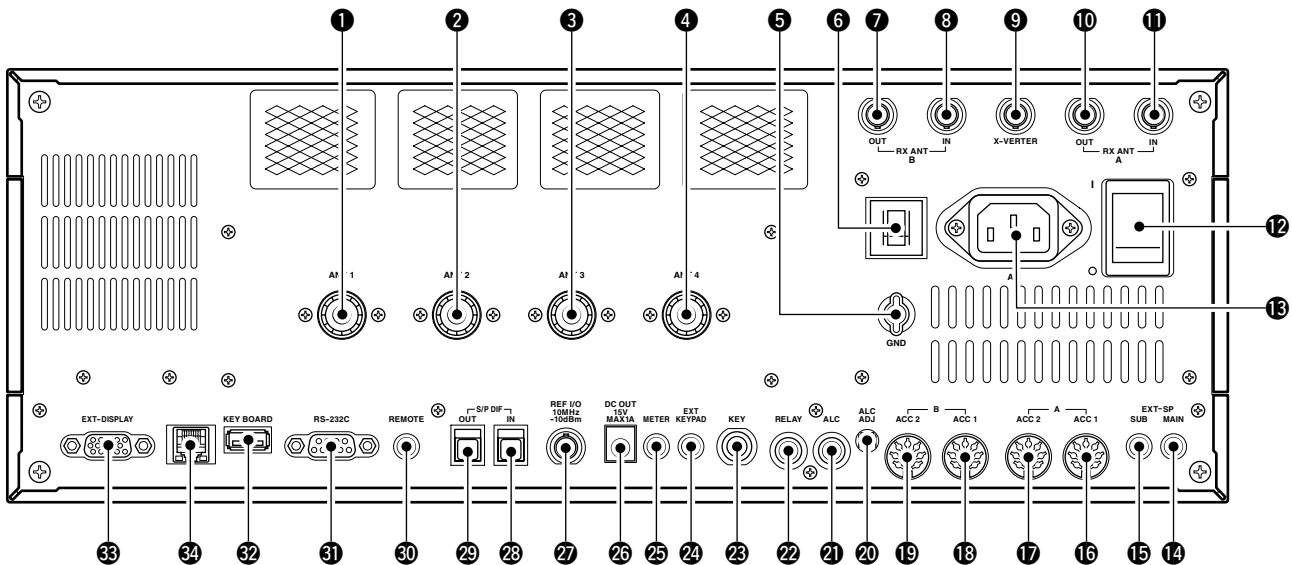

- ❶ ANTENNA CONNECTOR 1 [ANT 1] (p. 2-4)
 - ❷ ANTENNA CONNECTOR 2 [ANT 2] (p. 2-4)
 - ❸ ANTENNA CONNECTOR 3 [ANT 3] (p. 2-4)
 - ❹ ANTENNA CONNECTOR 4 [ANT 4] (p. 2-4)
- Accept a 50 Ω antenna with a PL-259 plug connector.

- ❺ GROUND TERMINAL [GND] (p. 2-3)
- Connect this terminal to a ground to prevent electrical shocks, TVI, BCI and other problems.

- ❻ CIRCUIT BREAKER
- Cuts off the AC input when over-current occurs.

- ❼ RECEIVE ANTENNA B OUT [RX ANT B- OUT]
 - ❽ RECEIVE ANTENNA B IN [RX ANT B- IN]
- Located between the transmit/receive switching circuit and receiver's RF stage in SUB band (MAIN band during split operation).

Connects an external unit, such as preamplifier or RF filter, using BNC connectors, if desired.

When no external unit is connected, [RX ANT B- OUT] and [RX ANT B- IN] must be shorted with the supplied coaxial cable. (p. 2-2)

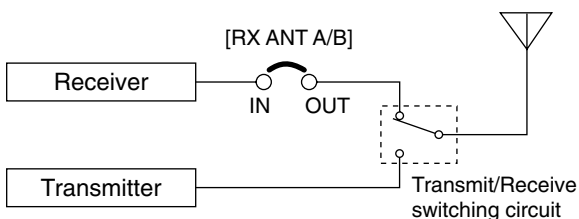

- ❾ TRANSVERTER CONNECTOR [X-VERTER] (p. 2-5)
- External transverter input/output connector. Activated by voltage applied to [ACC 2] pin 6, or when the transverter function is in use. (pgs. 2-10, 4-6)

- ❿ RECEIVE ANTENNA A OUT [RX ANT A- OUT]
 - ⓫ RECEIVE ANTENNA A IN [RX ANT A- IN]
- Located between the transmit/receive switching circuit and receiver's RF stage in MAIN band (SUB band during split operation).

Connects an external unit, such as preamplifier or RF filter, using BNC connectors, if desired.

When no external unit is connected, [RX ANT A- OUT] and [RX ANT A- IN] must be shorted with the supplied coaxial cable. (p. 2-2)

- ⓫ MAIN POWER SWITCH [I/O] (p. 3-2)
- Turns the internal power supply ON and OFF.

- ⓬ AC POWER SOCKET [AC] (p. 2-4)
- Connects the supplied AC power cable to an AC line-voltage receptacle.

- ⓭ EXTERNAL SPEAKER JACK MAIN [EXT-SP MAIN] (p. 2-5)
 - ⓮ EXTERNAL SPEAKER JACK SUB [EXT-SP SUB] (p. 2-5)
- Connects an external speaker (4–8 Ω), if desired.

16 ACCESSORY SOCKET 1 A [ACC 1-A]

17 ACCESSORY SOCKET 2 A [ACC 2-A]

18 ACCESSORY SOCKET 1 B [ACC 1-B]

19 ACCESSORY SOCKET 2 B [ACC 2-B]

Enable connection of external equipment such as a linear amplifier, an automatic antenna selector/tuner, a TNC for data communications, etc.
 • See p. 2-10 for socket information.

20 ALC LEVEL ADJUSTMENT POT [ALC ADJ]

Adjusts the ALC levels.
 No adjustment is required when the ALC output level of the connected non-Icom linear amplifier is 0 to -4 V DC.

21 ALC INPUT JACK [ALC] (p. 2-7)

Connects to the ALC output jack of a non-Icom linear amplifier.

22 T/R CONTROL JACK [RELAY] (p. 2-7)

Goes to ground when transmitting to control an external unit, such as a non-Icom linear amplifier.

NOTE: T/R control voltage and current must be lower than 16 V DC/0.5 A (or 250 V AC, 200 mA with MOS-FET switching).

23 STRAIGHT KEY JACK [KEY] (p. 2-4)

Accepts a straight key or external electronic keyer with 1/4 inch standard plug.

- [ELEC-KEY] on the front panel can be used for a straight key or external electronic keyer. Deactivate the internal electronic keyer in keyer set mode. (p. 4-12)

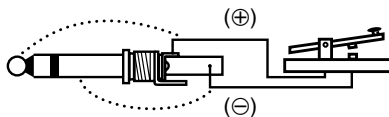

24 EXTERNAL KEYPAD JACK [EXT KEYPAD]

(p. 2-6)
 Connects an external keypad for direct voice memory or electronic keyer control.
 Transceiver mute control line (both transmit and receive) is also supported.

25 METER JACK [METER] (p. 2-6)

Outputs the receiving signal strength level signal, transmit output power, VSWR, ALC, speech compression, Vd or Id level for external meter indication.

26 DC OUTPUT JACK [DC OUT] (p. 2-6)

Outputs a regulated 14 V DC (approx.) for external equipment. Connected in parallel with 13.8 V outputs of [ACC 1] and [ACC 2]. (max. 1 A in total)

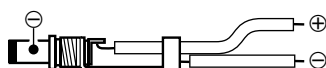

27 REFERENCE SIGNAL INPUT/OUTPUT TERMINAL [REF I/O]

Inputs/outputs a 10 MHz reference signal.

28 S/P DIF INPUT TERMINAL [S/P DIF- IN] (p. 2-6)

29 S/P DIF OUTPUT TERMINAL [S/P DIF- OUT]

(p. 2-6)
 Connects external equipment that supports S/P DIF input/output.

30 CI-V REMOTE CONTROL JACK [REMOTE]

- (p. 2-5)
- ➔ Connects a PC via the optional CT-17 CI-V LEVEL CONVERTER for external control of the transceiver.
 - ➔ Used for transceive operation with another Icom CI-V transceiver or receiver.

31 RS-232C TERMINAL [RS-232C] (p. 2-5)

Connects an RS-232C cable, D-sub 9-pin to connect the IC-7800 to a PC.
 Can be used for remotely control the IC-7800 without the optional CT-17, or for RTTY/PSK31 decoded signal output. The [RS-232C] interface is wired as a modem (DCE).

32 KEYBOARD CONNECTOR [KEYBOARD]

- (p. 2-6)
 Connects a PC keyboard for RTTY and PSK31 operations.
 • USB (Universal Serial Bus) keyboard is supported.

33 EXTERNAL DISPLAY TERMINAL [EXT-DISPLAY]

(p. 2-6)
 Connects to an external display monitor.
 • At least 800x600 pixel display is necessary.

34 ETHERNET CONNECTOR (p. 16-6)

Connects to a PC through a LAN (Local Area Network).

■ LCD display

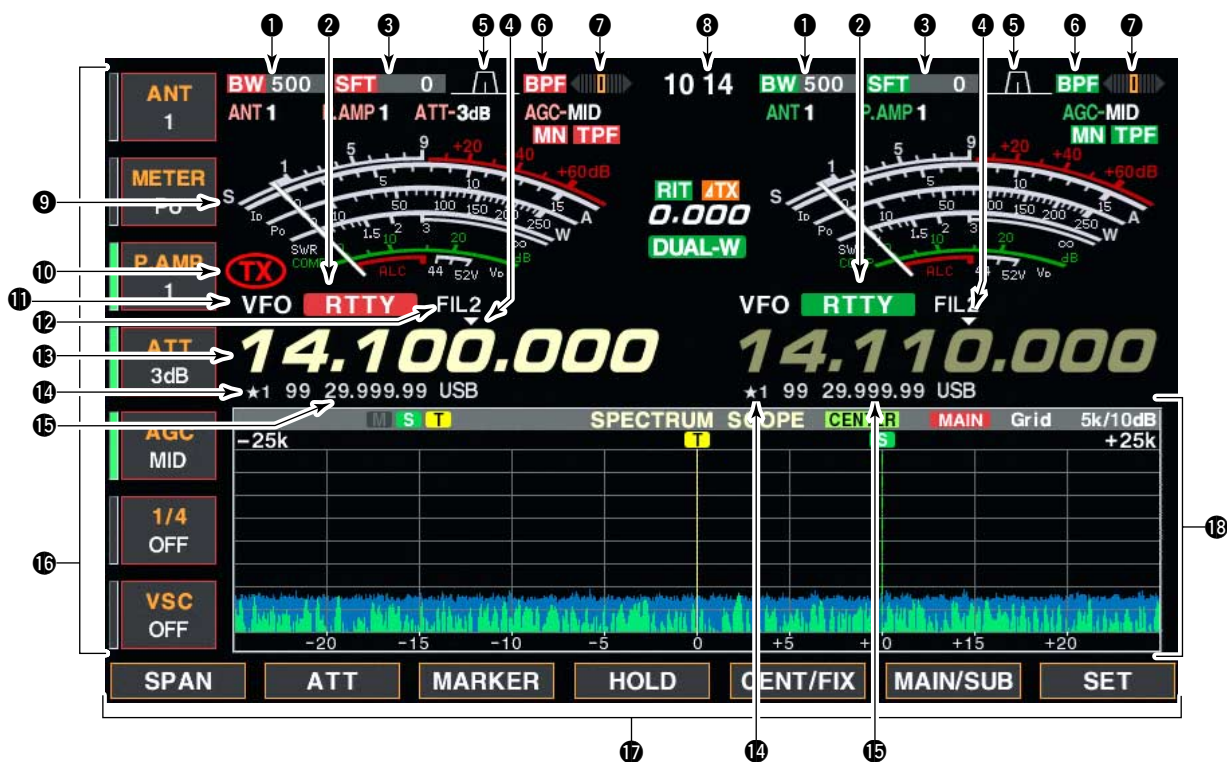

- 1 BAND WIDTH INDICATOR** (p. 5-12)
Shows the passband width of the IF filter.
- 2 MODE INDICATOR**
Shows the selected mode.
- 3 SHIFT FREQUENCY INDICATOR** (p. 5-12)
Shows the shift frequency of the IF filter.
- 4 QUICK TUNING INDICATOR** (p. 3-6)
Appears when the quick tuning step function is in use.
- 5 PASSBAND WIDTH INDICATOR** (p. 5-12)
Graphically displays the passband width for twin PBT operation and center frequency for IF shift operation.
- 6 BANDPASS FILTER INDICATOR**
Appears when the narrow filter (500 Hz or less) is selected during CW, RTTY or PSK31 operation.
- 7 RTTY TUNING INDICATOR**
Shows the tuning level in RTTY mode.
- 8 CLOCK READOUT**
Shows the current time.
- 9 S/Rf METER** (p. 3-10)
Shows the signal strength while receiving. Shows the relative output power, SWR, ALC or compression levels while transmitting.
- 10 TX INDICATOR**
Indicates the frequency readout for transmit.
- 11 VFO/MEMORY CHANNEL INDICATOR** (p. 3-3)
Indicates the VFO mode or selected memory channel number.
- 12 IF FILTER INDICATOR**
Shows the selected IF filter number.
- 13 FREQUENCY READOUTS**
Shows the operating frequency.
• Gray characters are used for non-active readout.
- 14 SELECT MEMORY CHANNEL INDICATOR** (p. 9-7)
Indicates the displayed memory channel is set as a select memory channel.
- 15 MEMORY CHANNEL READOUTS**
 - Shows the selected memory channel contents in VFO mode.
 - Shows the VFO contents in memory mode.
- 16 MULTI-FUNCTION SWITCH GUIDE**
Indicates the function of the multi-function switches.
- 17 LCD FUNCTION SWITCH GUIDE**
Indicates the function of the LCD function switches ([F-1] – [F-7]).
- 18 MULTI-FUNCTION SCREEN**
Shows the screens for the multi-function digital meter, spectrum scope, voice recorder, memory channel, scan, memory keyer, RTTY decoder, PSK decoder, IF filter selection or set modes, etc.

Screen menu arrangement

The following screens can be selected from the start up screen. Choose the desired screen using the following chart.

Pushing [EXIT/SET] several times returns to the start up screen. See p. 12-3 for set mode arrangement.

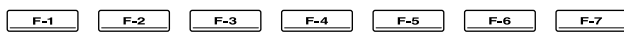
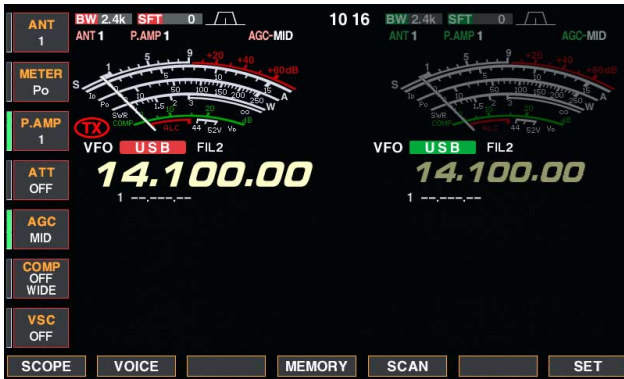

• Spectrum scope screen (p. 5-2)

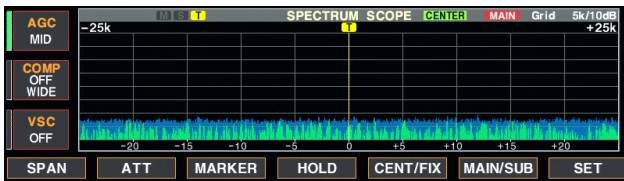

• Voice recorder screen (p. 7-3)



• Memory keyer screen (CW mode; p. 4-8)

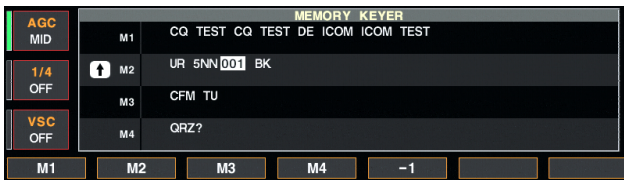

• RTTY decoder screen (p. 4-13)

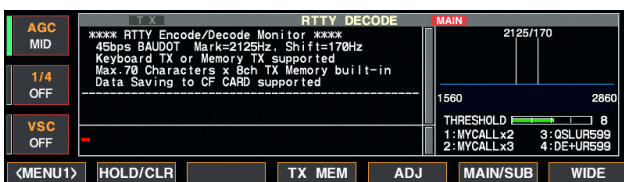

• PSK31 decoder screen (p. 4-21)

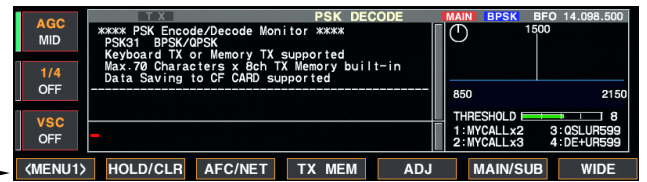

• Memory channel screen (p. 8-3)

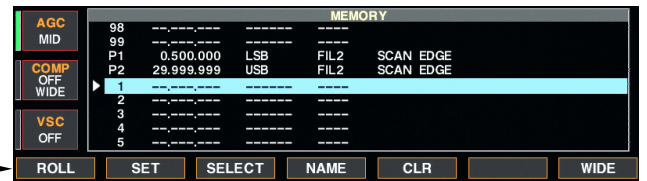

• Scan screen (VFO mode; p. 9-4)

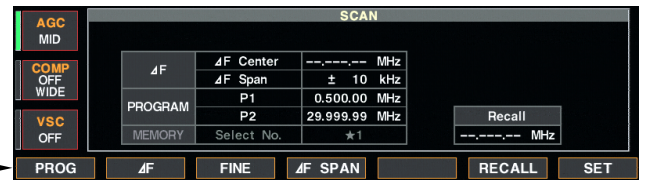

• Scan screen (Memory mode; p. 9-6)

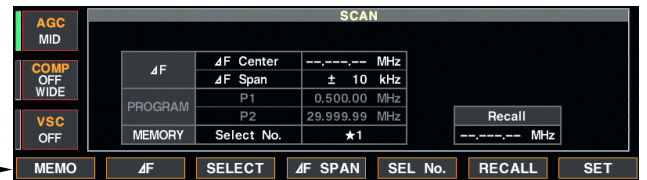

• Set mode menu screen (p. 12-2)

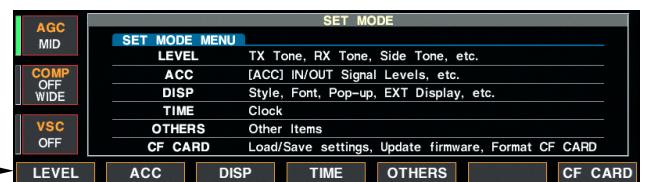

■ Unpacking	2-2
■ Antenna jumper cable connection	2-2
■ Selecting a location	2-2
■ Rack mounting handle attachment	2-2
■ Grounding	2-3
■ Antenna connection	2-3
■ CF (Compact Flash) memory card	2-3
■ Required connections	2-4
◇ Front panel	2-4
◇ Rear panel	2-4
■ Advanced connections	2-5
◇ Front panel	2-5
◇ Rear panel—1	2-5
◇ Rear panel—2	2-6
■ Linear amplifier connections	2-7
◇ Connecting the IC-PW1	2-7
◇ Connecting a non-Icom linear amplifier	2-7
■ Transverter jack information	2-8
■ FSK and AFSK (SSTV) connections	2-8
■ Microphone connector information	2-9
■ Microphones (options)	2-9
◇ SM-20	2-9
◇ HM-36	2-9
■ Accessory connector information	2-10

 **CAUTION!:** The transceiver weighs approx. 25 kg (55 lb). Always have two people available to carry, lift or turn over the transceiver.

■ Unpacking

After unpacking, immediately report any damage to the delivering carrier or dealer. Keep the shipping cartons.

For a description and a diagram of accessory equipment included with the IC-7800, see 'Supplied accessories' on p. iii of this manual.

■ Antenna jumper cable connection

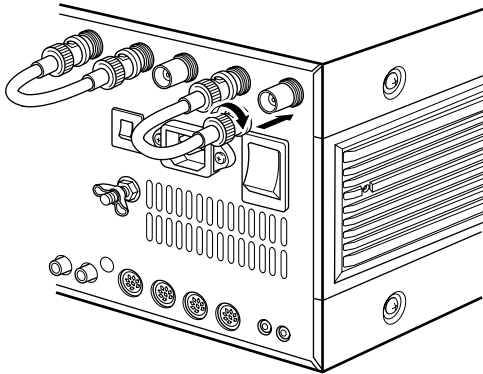

Connect the supplied coaxial cable (terminated with BNC connectors) between [RX ANT A— IN] and [RX ANT A— OUT], and, [RX ANT B— IN] and [RX ANT B— OUT], respectively.

When connecting an external filter unit, pre-amplifier, etc., connect the unit between [RX ANT A/B— IN] and [RX ANT A/B— OUT] connectors.

■ Selecting a location

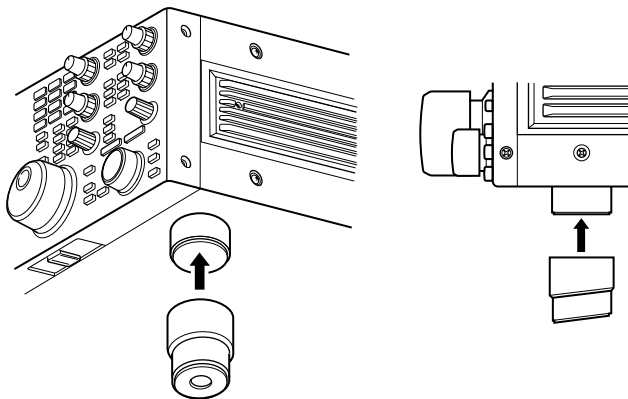

Select a location for the transceiver that allows adequate air circulation, free from extreme heat, cold, or vibrations, and away from TV sets, TV antenna elements, radios and other electromagnetic sources.

The base of the transceiver has an adjustable stand for desktop use. Set the stand to one of two angles depending on your operating preference.

■ Rack mounting handle attachment

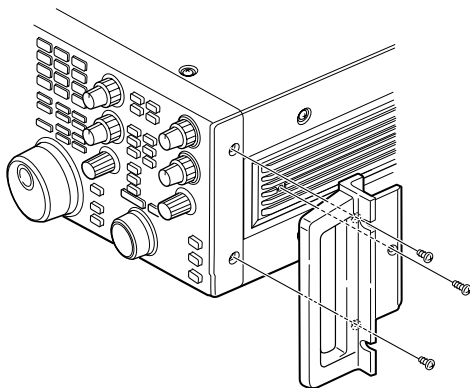

Remove the four screws from both sides of the front panel and the two screws from both sides of the side panel, then attach the rack mounting handles to the sides of the transceiver using the supplied screws.

■ Grounding

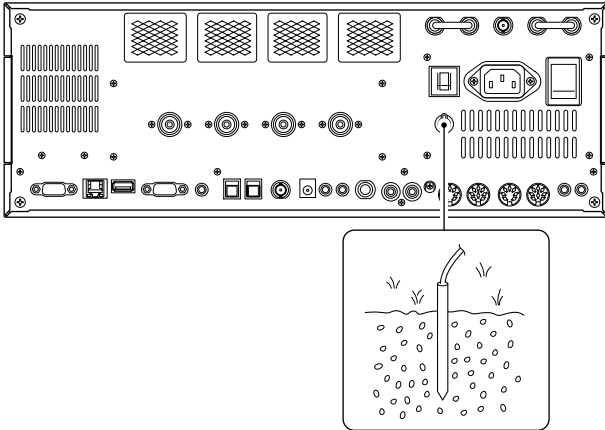

To prevent electrical shock, television interference (TVI), broadcast interference (BCI) and other problems, ground the transceiver through the GROUND terminal on the rear panel.

For best results, connect a heavy gauge wire or strap to a long earth-sunk copper rod. Make the distance between the [GND] terminal and ground as short as possible.

⚠ WARNING: NEVER connect the [GND] terminal to a gas or electric pipe, since the connection could cause an explosion or electric shock.

■ Antenna connection

PL-259 CONNECTOR INSTALLATION EXAMPLE

- ① Slide the coupling ring down. Strip the cable jacket and soft solder.
- ② Strip the cable as shown at left. Soft solder the center conductor.
- ③ Slide the connector body on and solder it.
- ④ Screw the coupling ring onto the connector body.

30 mm ≈ 9/8 in 10 mm ≈ 3/8 in 1-2 mm ≈ 1/16 in

For radio communications, the antenna is of critical importance, along with output power and receiver sensitivity. Select antenna(s), such as a well-matched 50 Ω antenna, and feedline. We recommend 1.5:1 or better of Voltage Standing Wave Ratio (VSWR) for your desired band. Of course, the transmission line should be a coaxial cable.

When using 1 antenna, use the [ANT1] connector.

⚠ CAUTION: Protect your transceiver from lightning by using a lightning arrestor.

Antenna SWR

Each antenna is tuned for a specified frequency range and SWR may be increased out-of-range. When the SWR is higher than approx. 2.0:1, the transceiver's power drops to protect the final transistors. In this case, an antenna tuner is useful to match the transceiver and antenna. Low SWR allows full power for transmitting. The IC-7800 has an SWR meter to monitor the antenna SWR continuously.

■ CF (Compact Flash) memory card

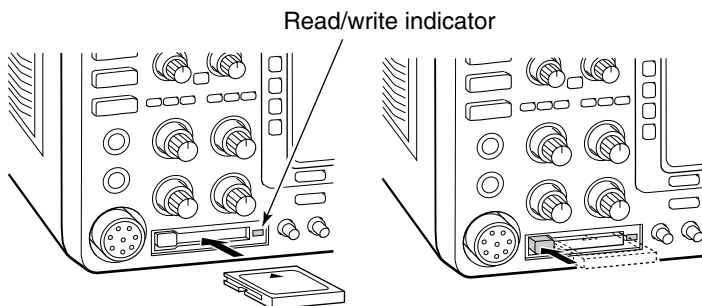

Insert the supplied CF (Compact Flash) memory card into the CF memory card slot.

- To remove the CF memory card, push-in the button, located at left hand side of the slot.

⚠ Make sure to install the memory card correctly. **NEVER** insert or remove the CF memory card when the read/write indicator lights or blinks.

Required connections

Front panel

CW key

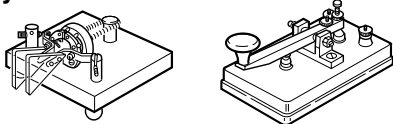

A straight or bug key can be used when the internal electronic keyer is turned OFF in keyer set mode. (p. 4-12)

Microphones (p. 2-9)



Optional SM-20

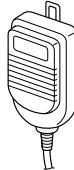

Optional HM-36

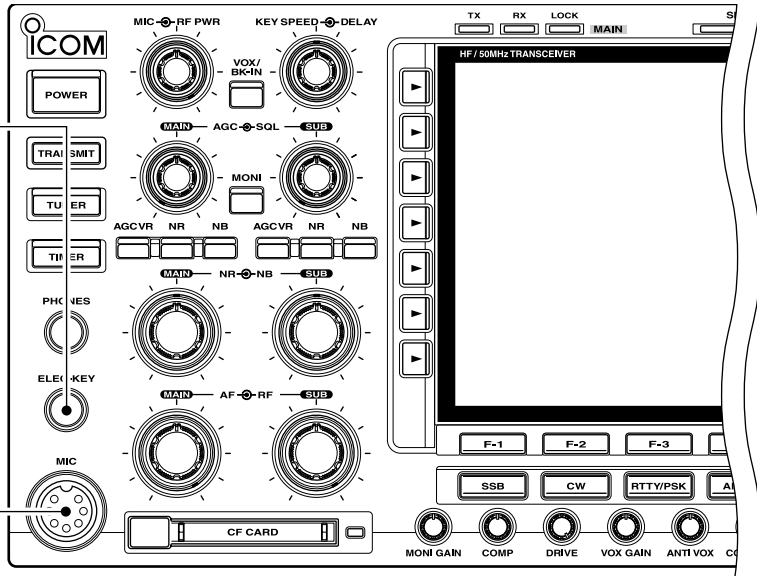

Rear panel

Antenna 1, 2, 3, 4 (p. 2-3)

[Example]: ANT1 for 1.8–18 MHz bands, ANT 2 for 21–28 bands
ANT3 for 50 MHz band, ANT 4 for receive antenna.

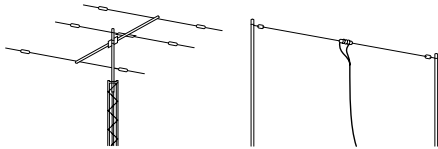

NOTE: Attach the supplied antenna connector cap when no antenna or external equipment is connected.

A jumper cable is connected.

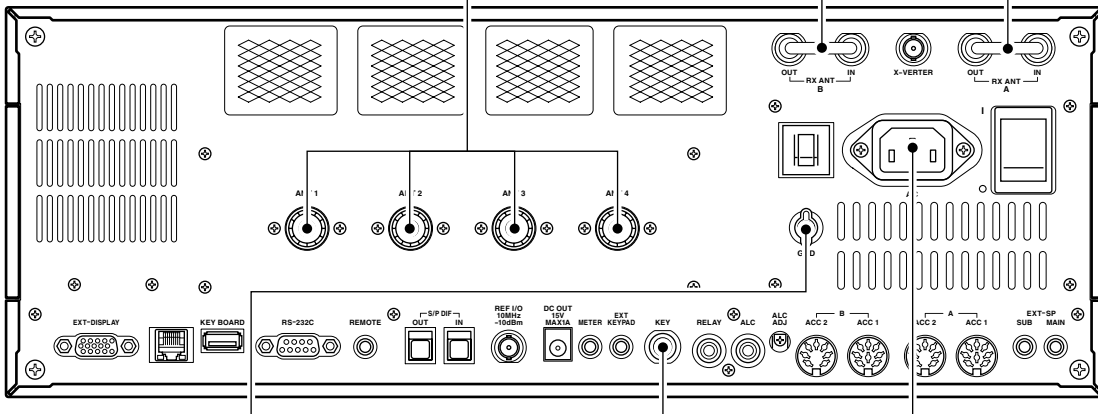

Ground (p. 2-3)

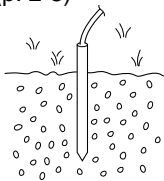

Use the heaviest gauge wire or strap available and make the connection as short as possible.

Grounding prevents electrical shocks, TVI and other problems.

Straight key

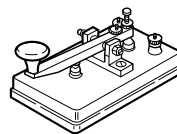

AC outlet

WARNING:
Use the supplied AC power cable only.

Advanced connections

Front panel

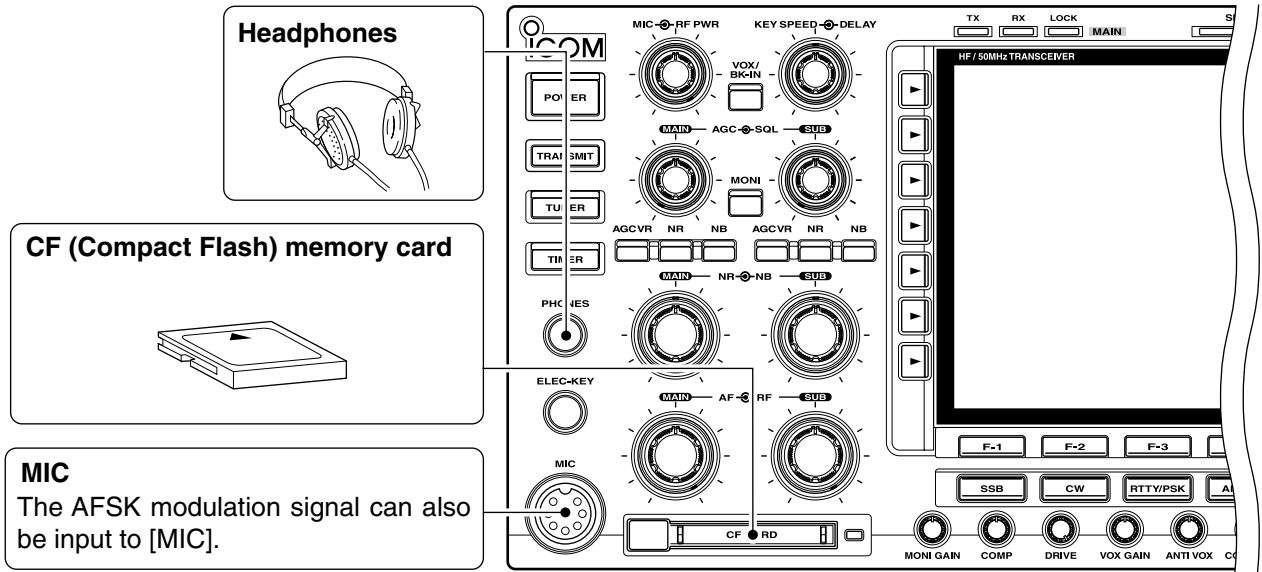

Rear panel— 1

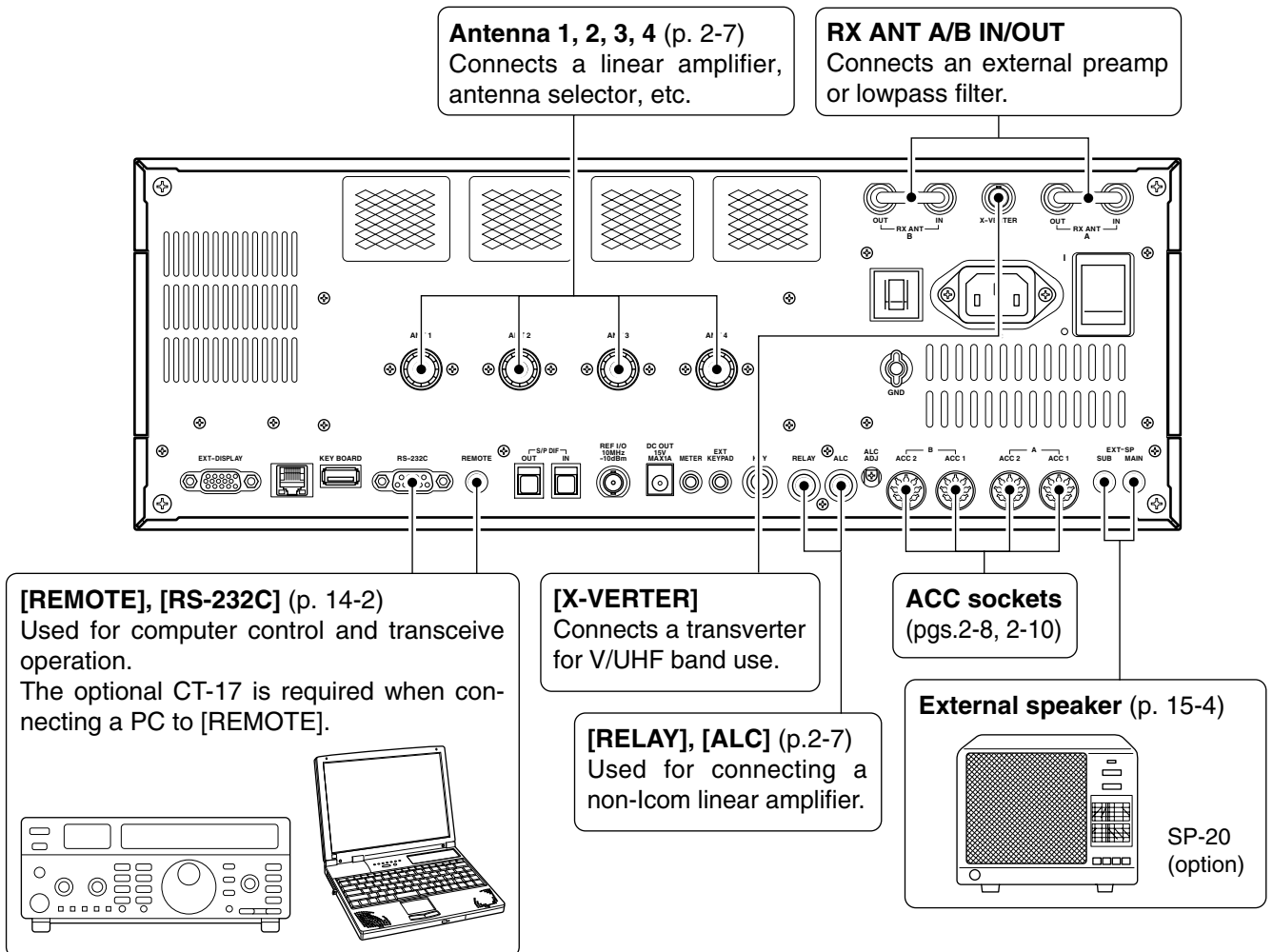

◇ Rear panel— 2

External Display



Connects a PC-style monitor display (at least 800×600 resolution). Video output signal can be turned ON and OFF in set mode (p. 12-12)

Keyboard

Connects an USB type PC keyboard directly for RTTY/PSK31 operation, as well as other text edit operations.

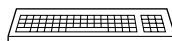

[DC OUT]

Outputs regulated 14 V (approx.) DC for external equipment power supply. (max. 1 A capacity)

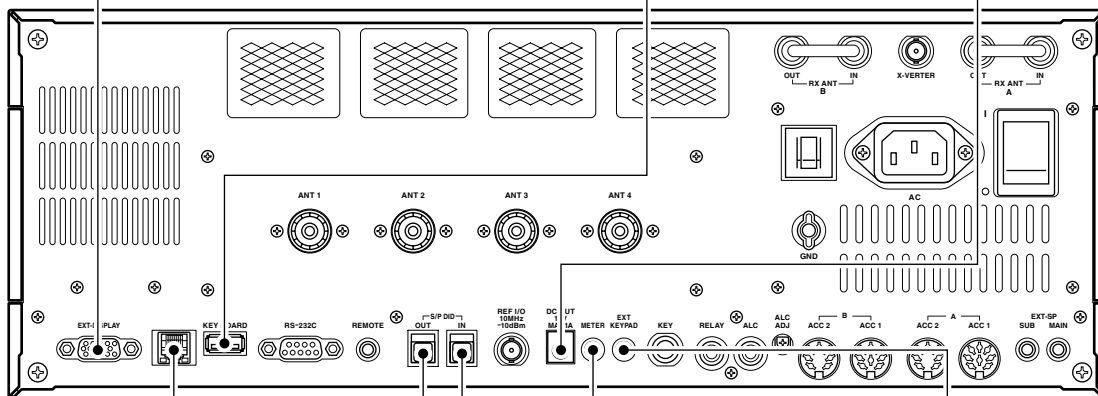

Ethernet connector (p. 16-6)

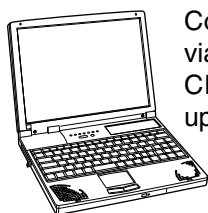

Connects a PC via a LAN for the CPU firmware update.

[METER]

Connects an external meter, etc.

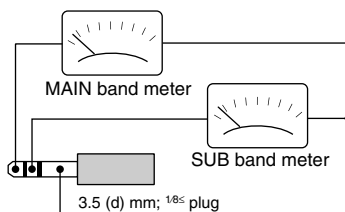

[S/P DEAF IN/OUT]



Connects a PC for audio signal data input/output.
48 kHz, 16-bit Stereo output (L=Main band; R=Sub band)

External keypad

Connects an external keypad for direct voice memory and memory keyer controls.

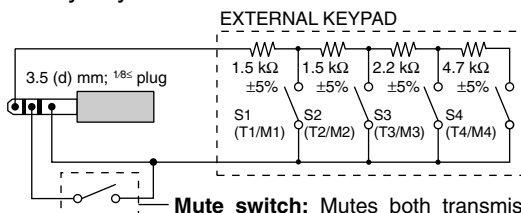

Mute switch: Mutes both transmission and reception when switched ON during transceive operation, etc.

Linear amplifier connections

Connecting the IC-PW1/EURO

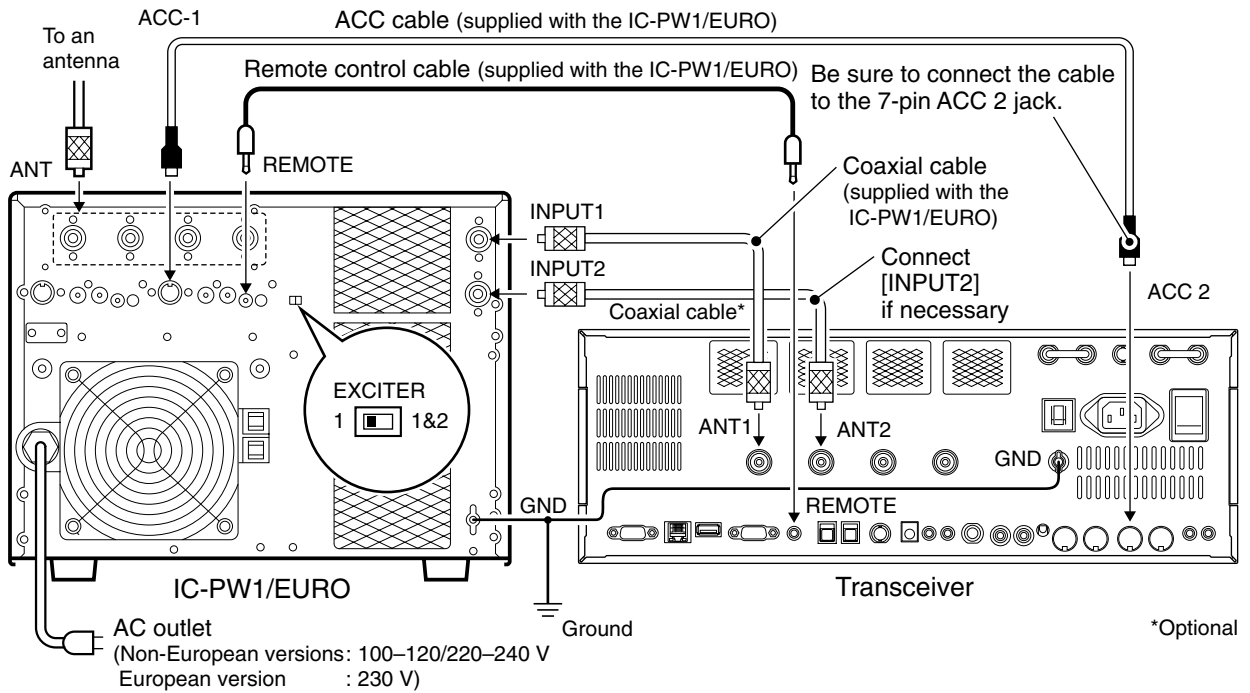

Connecting a non-Icom linear amplifier

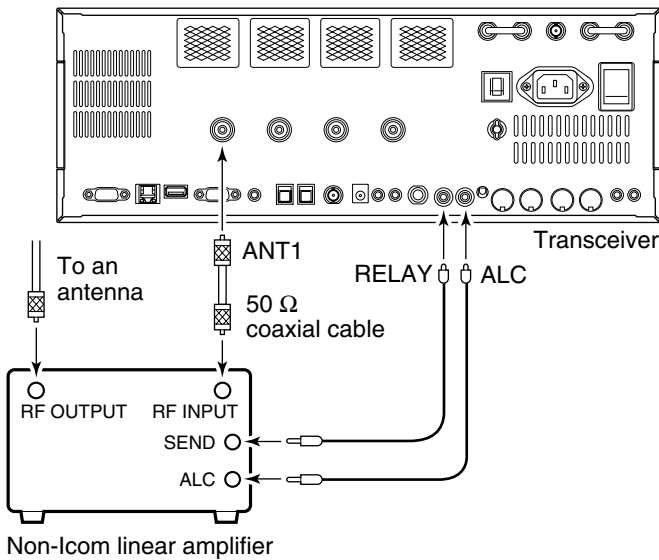

⚠ WARNING:

Set the transceiver output power and linear amplifier ALC output level referring to the linear amplifier instruction manual.

The ALC input level must be in the range 0 V to -4 V, and the transceiver does not accept positive voltage. Non-matched ALC and RF power settings could cause a fire or ruin the linear amplifier.

The maximum control level of [RELAY] jack is 16 V/0.5 A DC with initial setting, and 250 V/200 mA with "MOS-FET" setting (see p. 12-9 for details). Use an external relay unit when your non-Icom linear amplifier requires control voltage and/or current greater than specified.

■ Transverter jack information

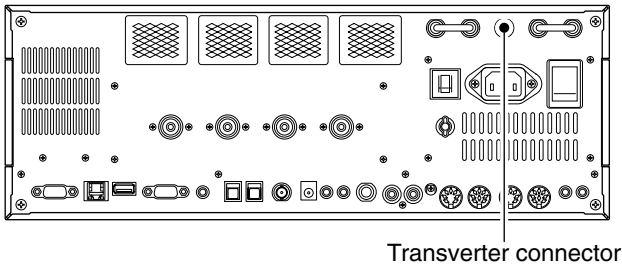

When 2 to 13.8 V is applied to pin 6 of [ACC 2], the [X-VERTER] connector is activated for transverter operation and the antenna connectors do not receive or transmit any signals. (p. 4-6)

While receiving, [X-VERTER] connector can be activated as an input terminal from an external transverter.

While transmitting, the [X-VERTER] connector outputs signals of the displayed frequency at -20 dBm (22 mV) as signals for the external transverter.

■ FSK and AFSK (SSTV) connections

To connect a TNC or scan converter, etc., refer to the diagram below.

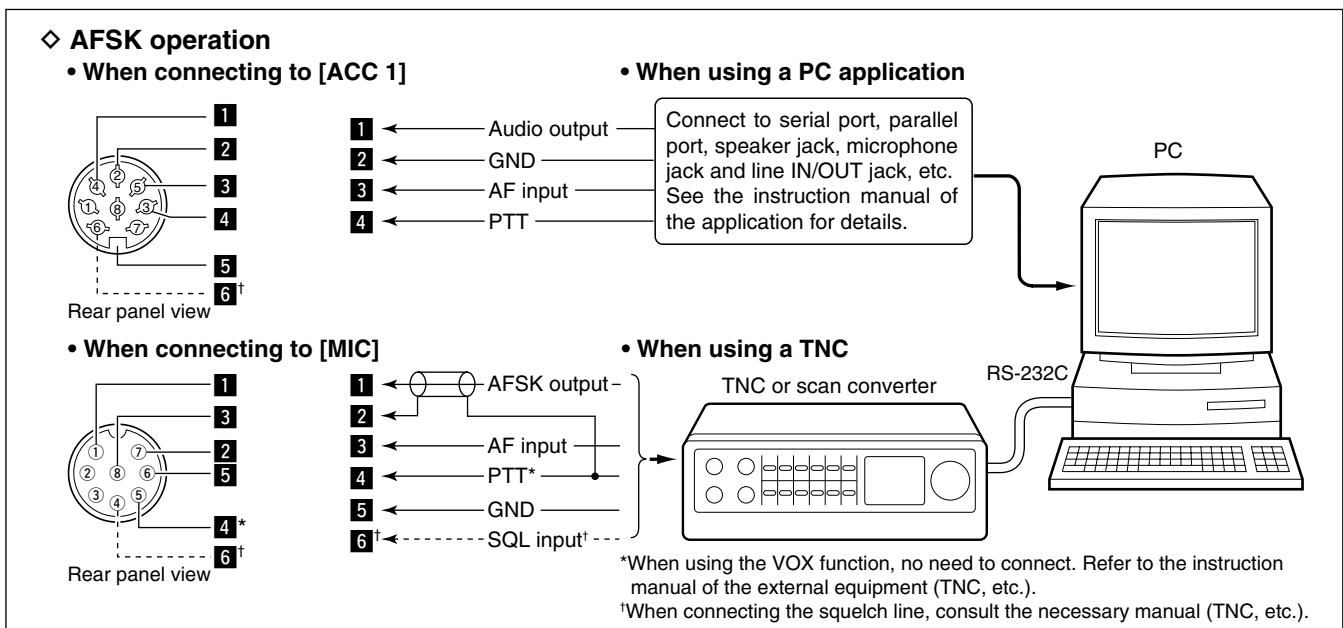
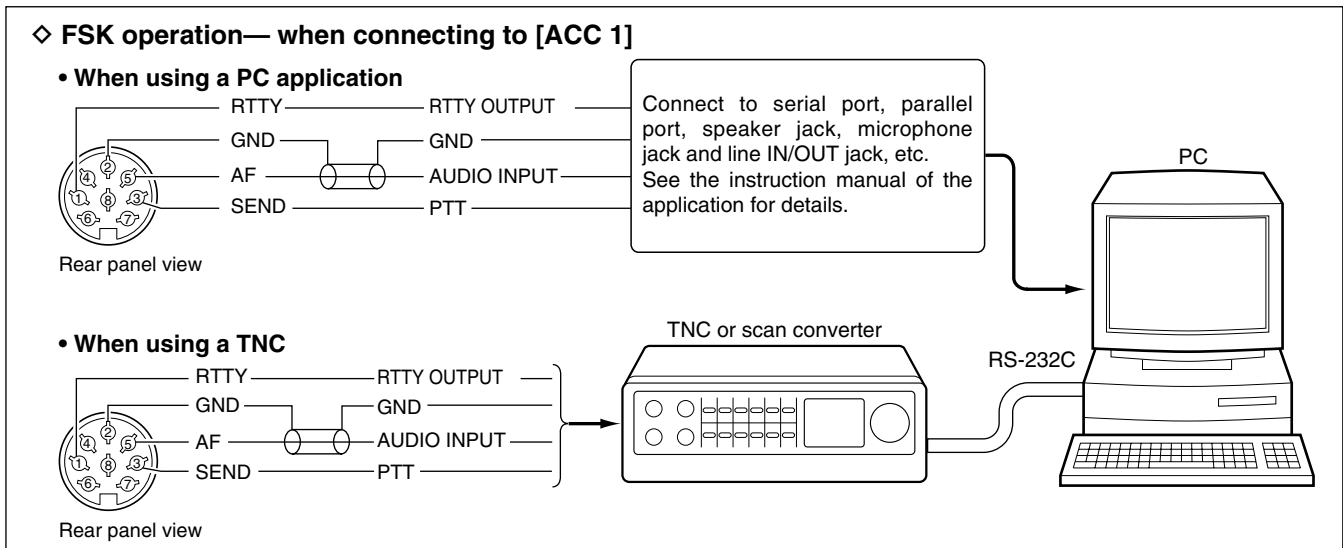

Microphone connector information

(Front panel view)

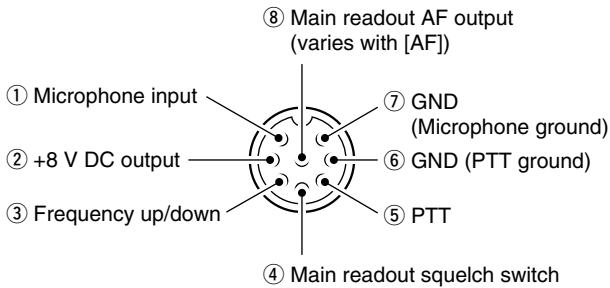

[MIC] Pin No.	FUNCTION	DESCRIPTION
②	+8 V DC output	Max. 10 mA
③	Frequency up	Ground
	Frequency down	Ground through 470 Ω
④	Squelch open	“Low” level
	Squelch closed	“High” level

CAUTION: DO NOT short pin 2 to ground as this can damage the internal 8 V regulator.
NOTE: DC voltage is applied to pin 1 for microphone operation. Take care when using a non-Icom microphone.

Microphones (options)

◇ SM-20

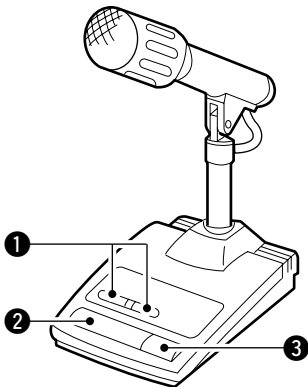

◇ HM-36

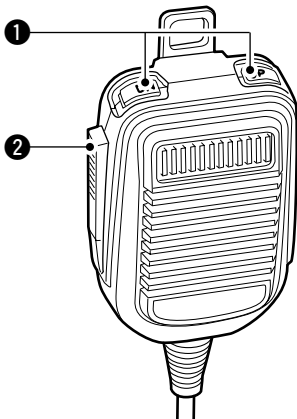

① UP/DOWN SWITCHES [UP]/[DN]

Change the selected readout frequency or memory channel.

- Continuous pushing changes the frequency or memory channel number continuously.
- While pushing [XFC], the transmit readout frequency can be controlled while in split frequency operation.
- The [UP]/[DN] switch can simulate a key paddle. Preset in the keyer set mode. (p. 4-12)

② PTT SWITCH

Push and hold to transmit; release to receive.

③ PTT LOCK SWITCH (available for SM-20 only)

Push to toggle between transmit and receive.

■ Accessory connector information

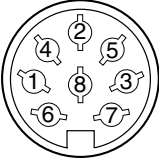
ACC 1	PIN No.	NAME	DESCRIPTION	SPECIFICATIONS
	1	RTTY	Controls RTTY keying	“High” level : More than 2.4 V “Low” level : Less than 0.6 V Output current : Less than 2 mA
	2	GND	Connects to ground.	Connected in parallel with ACC 2 pin 2.
	3	SEND	Input/output pin. Goes to ground when transmitting. When grounded, transmits.	Ground level : -0.5 V to 0.8 V Output current : Less than 20 mA Input current (Tx) : Less than 200 mA Connected in parallel with ACC 2 pin 3.
	4	MOD	Modulator input. Connects to a modulator.	Input impedance : 10 kΩ Input level : Approx. 100 mV rms
	5	AF	AF detector output. Fixed, regardless of [AF] position in default settings. (see notes below)	Output impedance : 4.7 kΩ Output level : 100–300 mV rms
	6	SQLS	Squelch output. Goes to ground when squelch opens.	SQL open : Less than 0.3 V/5 mA SQL closed : More than 6.0 V/100 μA
	7	13.8 V	13.8 V output when power is ON.	Output current : Max. 1 A Connected in parallel with ACC 2 pin 7.
	8	ALC	ALC voltage input.	Control voltage : -4 V to 0 V Input impedance : More than 10 kΩ Connected in parallel with ACC 2 pin 5.

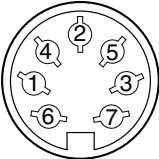
ACC 2	PIN No.	NAME	DESCRIPTION	SPECIFICATIONS
	1	8 V	Regulated 8 V output.	Output voltage : 8 V ±0.3 V Output current : Less than 10 mA
	2	GND	Same as ACC 1 pin 2.	
	3	SEND	Same as ACC 1 pin 3.	
	4	BAND	Band voltage output. (Varies with amateur band)	Output voltage : 0 to 8.0 V
	5	ALC	Same as ACC 1 pin 8.	
	6	TRV	Activates [X-VERTER] input/output when “HIGH” voltage is applied.	Input impedance : More than 10 kΩ Input voltage : 2 to 13.8 V
	7	13.8 V	Same as ACC 1 pin 7.	

 **NOTE:** If the CW side tone level limit or beep level limit is in use, the CW side tone or beep tone decreases from the fixed level when the [AF] control is rotated above a specified level. (p. 12-5)

■ When first applying power (CPU resetting)	3-2
■ Initial settings	3-2
■ Main/Sub band selection	3-3
■ Selecting VFO/memory mode	3-3
■ Selecting an operating band	3-4
◇ Using the band stacking registers	3-4
■ Frequency setting	3-5
◇ Tuning with the main dial	3-5
◇ Direct frequency entry with the keypad	3-5
◇ Quick tuning step	3-6
◇ Selecting “kHz” step	3-6
◇ 1/4 tuning step function	3-6
◇ Selecting 1 Hz step	3-7
◇ Auto tuning step function	3-7
◇ Band edge warning beep	3-7
■ Operating mode selection	3-8
■ Volume setting	3-9
■ RF gain adjustment	3-9
■ Squelch level adjustment	3-9
■ Meter indication selection	3-10
◇ Multi-function digital meter	3-10
◇ Meter type selection	3-11
■ Basic transmit operation	3-12
◇ Transmitting	3-12
◇ Microphone gain adjustment	3-12
◇ Drive gain adjustment	3-13

■ When first applying power (CPU resetting)

Before first applying power, make sure all connections required for your system are complete by referring to Section 2. Then, reset the transceiver using the following procedure.

Resetting **CLEARs** all programmed contents in memory channels and returns programmed values in set mode to default values.

- ① Turn the main power ON with [I/O] on the rear panel.
 - The transceiver power is still OFF and the [POWER] indicator lights orange.
- ② While pushing and holding [F-INP•ENT] and [MW], push [POWER] to turn power ON.
 - The CPU is reset.
 - The CPU start-up takes approx. 5 sec.
 - The transceiver displays its initial VFO frequencies when resetting is complete.
- ③ Change the set mode settings after resetting, if desired.

In cooler temperatures, the LCD may appear dark and unstable after turning power ON. This is normal and does not indicate any equipment malfunction.

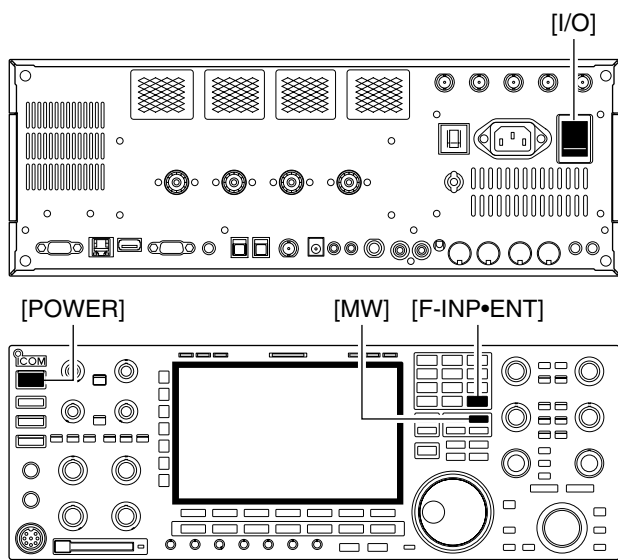

■ Initial settings

After resetting the transceiver, set controls as shown in the figure below.

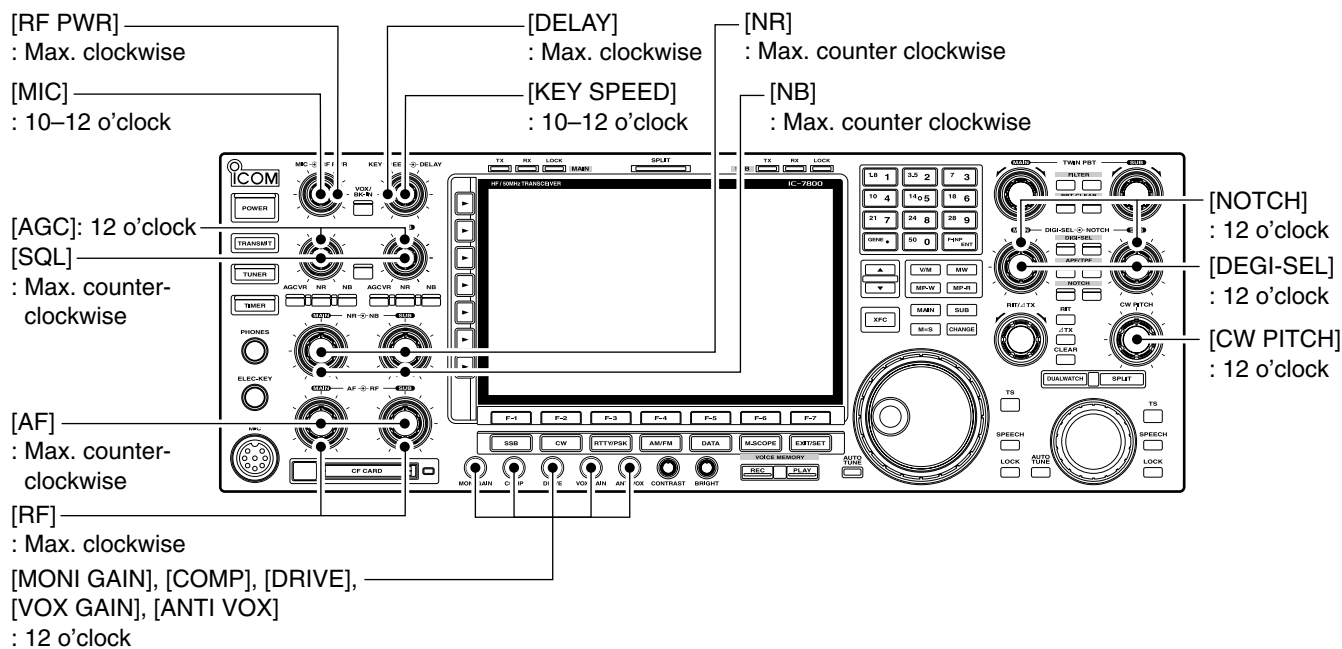

■ Main/Sub band selection

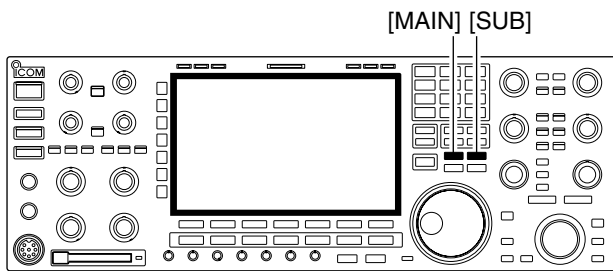

The IC-7800 has 2 identical receivers, main and sub. The main band is displayed on the left hand side, and the sub band is displayed on the right hand side of the LCD. Some functions can only be applied to the selected band and transmission occurs on the main band (except during split frequency operation).

- ➔ Push [MAIN] to select the main band.
 - The key backlight for [MAIN] lights.
 - Main band's frequency readout highlighted.
- ➔ Push [SUB] to select the sub band.
 - The key backlight for [SUB] lights.
 - Sub band's frequency readout highlighted.

■ Selecting VFO/memory mode

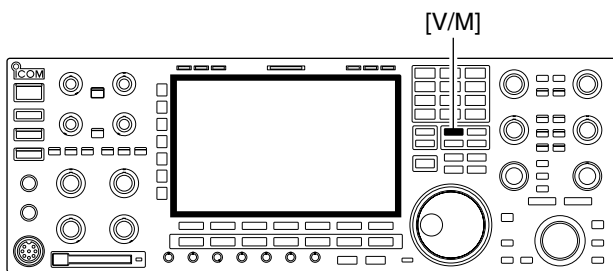

VFO is an abbreviation of Variable Frequency Oscillator, and is commonly referred to as a main tuning function.

The main dial is often called the "VFO knob."

- ➔ Push [V/M] to switch between VFO and memory modes.
 - "VFO" appears when in VFO mode, or the selected memory channel number appears when in memory mode.
 - Pushing [V/M] for 1 sec. transfers the contents of the selected memory channel to VFO. (p. 8-5)

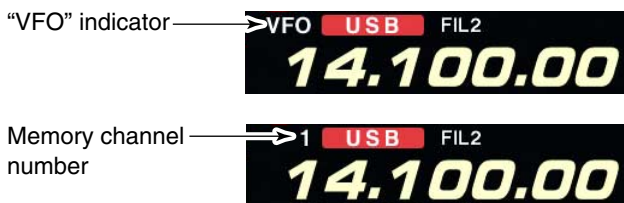

■ Selecting an operating band

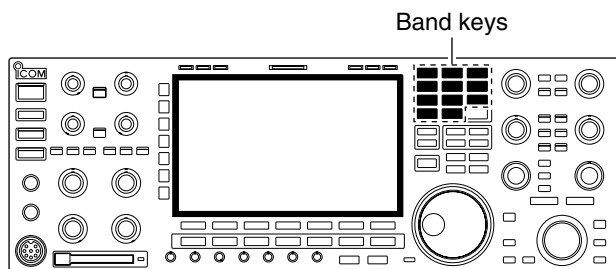

The triple band stacking register provides 3 memories for each band key, storing frequency and mode information.

If a band key is pushed once, the frequency and operating mode last used are called up. When the key is pushed again, another stored frequency and operating mode are called up.

This function is convenient when you operate 3 modes on one band. For example, one register is used for a CW frequency, another for an SSB frequency and the other one for an RTTY frequency.

See the table below for a list of the bands available and the default settings for each band.

BAND	REGISTER 1	REGISTER 2	REGISTER 3
1.8 MHz	1.900000 MHz CW	1.910000 MHz CW	1.915000 MHz CW
3.5 MHz	3.550000 MHz LSB	3.560000 MHz LSB	3.580000 MHz LSB
7 MHz	7.050000 MHz LSB	7.060000 MHz LSB	7.020000 MHz CW
10 MHz	10.120000 MHz CW	10.130000 MHz CW	10.140000 MHz CW
14 MHz	14.100000 MHz USB	14.200000 MHz USB	14.050000 MHz CW
18 MHz	18.100000 MHz USB	18.130000 MHz USB	18.150000 MHz USB
21 MHz	21.200000 MHz USB	21.300000 MHz USB	21.050000 MHz CW
24 MHz	24.950000 MHz USB	24.980000 MHz USB	24.900000 MHz CW
28 MHz	28.500000 MHz USB	29.500000 MHz USB	28.100000 MHz CW
50 MHz	50.100000 MHz USB	50.200000 MHz USB	51.000000 MHz FM
General	15.000000 MHz USB	15.100000 MHz USB	15.200000 MHz USB

◇ Using the band stacking registers

[Example]: 14 MHz band

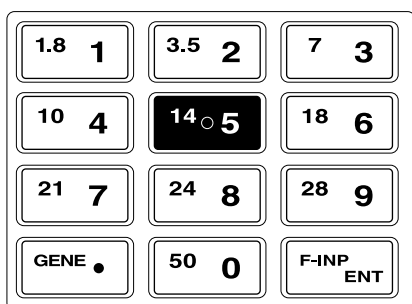

- ① Push [14•5], then select a frequency and an operating mode.
 - Frequency and operating mode are memorized in the first band stacking register.
- ② Push [14•5] again, then select another frequency and operating mode.
 - This frequency and operating mode are memorized in the second band stacking register.
- ③ Push [14•5] again, then select another frequency and operating mode.
 - This frequency and operating mode are memorized in the third band stacking register.
 - When a fourth frequency and operating mode are selected on a band, the first register set in step ①, is overwritten.

Frequency setting

The transceiver has several tuning methods for convenient frequency tuning.

◇ Tuning with the main dial

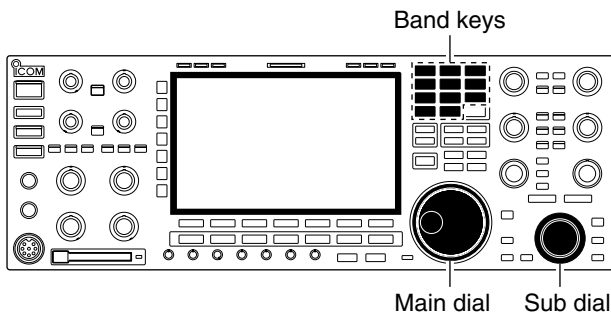

- ① Push the desired band key on the keypad 1–3 times.
 - 3 different frequencies can be selected on each band with the band key.
 - Push [MAIN] or [SUB] to select the band.
- ② Rotate the main dial to set the desired frequency in the main band, rotate the sub dial to set the desired frequency in the sub band.

▨ If the dial lock function is activated, the lock indicator lights, and the main dial does not function. In this case, push [LOCK] to deactivate the lock function. (see p. 5-18 for details)

✓ CONVENIENT!

The sub dial is always available for tuning the sub band. The sub dial allows quick tuning in the sub band without switching from main to sub.

◇ Direct frequency entry with the keypad

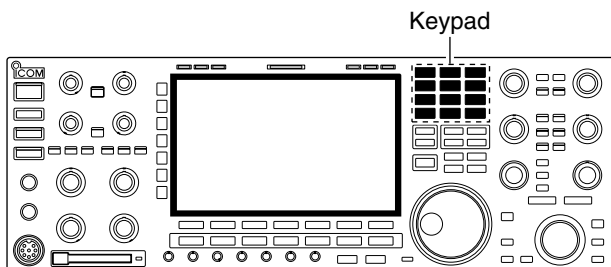

The transceiver has a keypad for direct frequency entry as described below.

- ① Push [MAIN] or [SUB] to select the band.
- ② Push [F-INP•ENT].
 - “F-INP” indicator appears and keypad backlight lights.
- ③ Input the desired frequency
 - Push [GENE•.] to input “.” (decimal point) between the MHz units and kHz units.
- ④ Push [F-INP•ENT] to set the input frequency.
 - To cancel the input, push [▲]/[▼] instead of [F-INP•ENT].

[EXAMPLE]

7.0000 MHz

Push [F-INP ENT] 21 7 [F-INP ENT]

VFO USB FIL2 F-INP 7.000.00

21.2400 MHz

Push [F-INP ENT] 3.5 2 1.8 1 [GENE•.] 3.5 2 10 4 [F-INP ENT]

VFO USB FIL2 F-INP 21.240.00

21.2400 MHz ⇒ 21.3600 MHz

Push [F-INP ENT] [GENE•.] 7 3 18 6 [F-INP ENT]

VFO USB FIL2 F-INP 21.360.00

3 BASIC OPERATIONS

◇ Quick tuning step

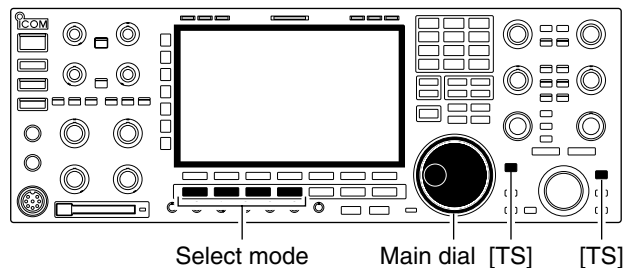

The operating frequency can be changed in kHz steps (0.1, 1, 5, 9, 10, 12.5, 20 or 25 kHz selectable) for quick tuning.

- ① Push [TS] to turn the quick tuning function ON.
 - “▼” appears when the quick tuning function ON.
- ② Rotate the main dial to change the frequency in programmed kHz steps.
- ③ Push [TS] again to turn OFF the indicator.
- ④ Rotate the main dial for normal tuning if desired.

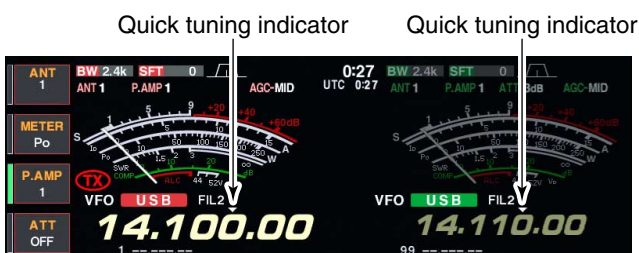

◇ Selecting “kHz” step



- ① Push [TS] to turn the quick tuning function ON and OFF.
 - “▼” appears when the quick tuning function ON.
- ② Push [TS] for 1 sec. to enter tuning step setting display.
 - Selected tuning steps for all modes appear.
- ③ Select the desired operating mode.
- ④ Rotate the main dial to select the desired tuning step.
- ⑤ Repeat steps ③ and ④ to select quick tuning steps for other modes, if desired.
- ⑥ Push [EXIT/SET] to exit the setting display.

NOTE: When entering quick tuning step set mode, the quick tuning function must be activated first. The main and sub bands have independent tuning step settings.

◇ 1/4 tuning step function

When operating in SSB data, CW, RTTY or PSK, the 1/4 tuning function is available. Dial rotation is reduced to 1/4 of normal speed when the 1/4 tuning function is ON for finer tuning control.

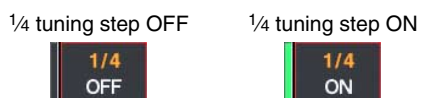

- Push [1/4] to toggle the 1/4 tuning function ON and OFF.
 - “1/4” appears when the 1/4 tuning function is ON.

◇ Selecting 1 Hz step



The minimum tuning step of 1 Hz can be used for fine tuning.

- ① Push [TS] to turn the quick tuning function OFF.
- ② Push [TS] for 1 sec. to turn the 1 Hz tuning step ON and OFF.

NOTE: 1 Hz tuning step activates for both main and sub bands simultaneously. Therefore, either [TS] can be used for the 1 Hz tuning step selection.

◇ Auto tuning step function

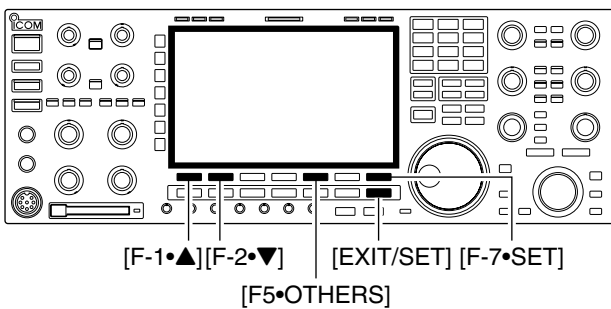

When rotating main or sub dial rapidly, the tuning speed accelerated automatically as selected.

- ① Push [EXIT/SET] several times to close a multi-function screen, if necessary.
- ② Push [F-7•SET] to select set mode menu screen.
 - Pushing and holding [EXIT/SET] for 1 sec. also selects set mode menu screen.
- ③ Push [F-5•OTHERS] to enter miscellaneous (others) set mode.
- ④ Push [F-1•▲] or [F-2•▼] to select “MAIN DIAL Auto TS” or “SUB DIAL Auto TS.”
 - “MAIN DIAL Auto TS” for main dial, “SUB DIAL Auto TS” for sub dial selection.
- ⑤ Rotate main dial to select the desired condition from high, low and OFF.
 - High : Approx. 5 times faster
 - Low : Approx. twice faster
 - OFF : Auto tuning step is turned OFF.
- ⑥ Push [EXIT/SET] to exit the set mode.

◇ Band edge warning beep

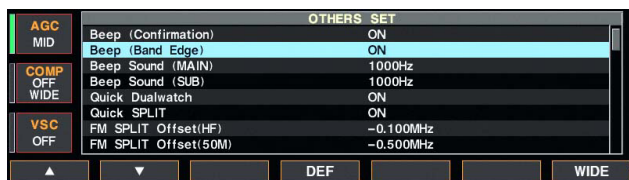

When you tune outside of an amateur band's frequency range, a warning beep sounds. This function can be turned OFF in set mode, if desired.

- ① Push [EXIT/SET] several times to close a multi-function screen, if necessary.
- ② Push [F-7•SET] to select set mode menu screen.
 - Pushing and holding [EXIT/SET] for 1 sec. also selects set mode menu screen.
- ③ Push [F5•OTHERS] to enter miscellaneous (others) set mode.
- ④ Push [F-1•▲] or [F-2•▼] to select “Beep (Band Edge).”
- ⑤ Rotate main dial to turn the band edge warning beep ON and OFF.
- ⑥ Push [EXIT/SET] to exit the set mode.

■ Operating mode selection

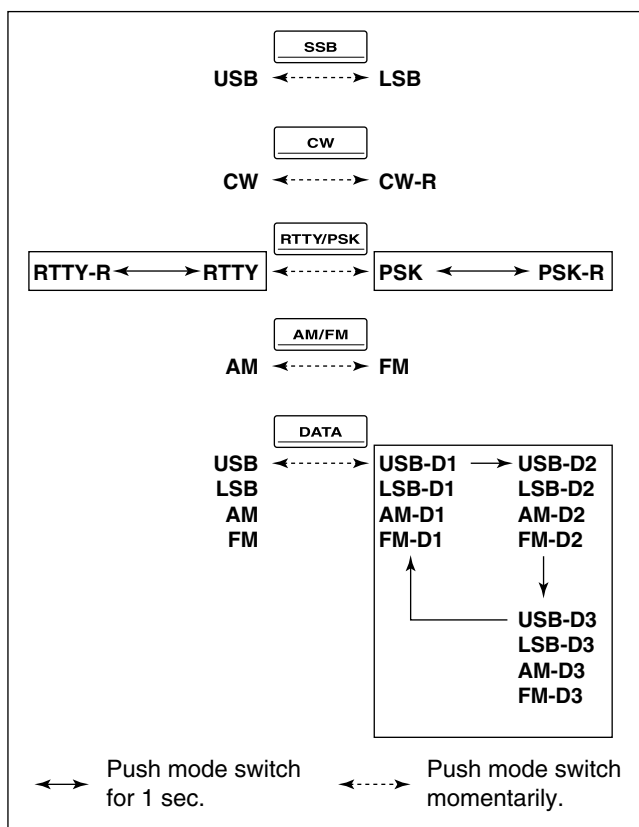
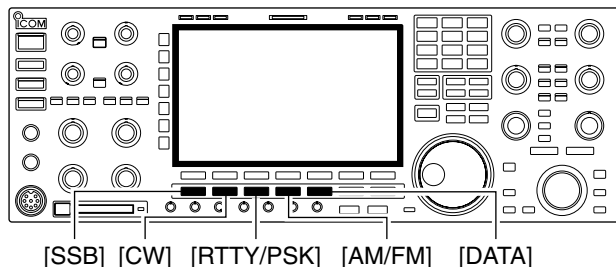

SSB (USB/LSB), SSB data (USB data/LSB data), CW, CW reverse (CW-R), RTTY, RTTY reverse (RTTY-R), PSK, PSK reverse (PSK-R), AM, AM data, FM and FM data modes are available in the IC-7800. Select the desired operation mode as follows.

To select a mode of operation, push the desired mode switch momentarily. Push the switch again to toggle between USB and LSB, CW and CW-R, RTTY/RTTY-R and PSK/PSK-R, AM and FM, if desired. Push the switch for 1 sec. to toggle between RTTY and RTTY-R, PSK and PSK-R, if desired.

See the diagram below left for the order of selection.

Microphone signals are muted when data mode is selected.

• Selecting SSB mode

- Push [SSB] to select USB or LSB.
 - USB is selected first when above 10 MHz; or LSB is selected first when below 10 MHz operation. (USB is selected when 5 MHz band is selected for the USA version.)
 - After USB or LSB is selected, push [SSB] to toggle between USB and LSB.

• Selecting CW mode

- Push [CW] to select CW.
 - After CW is selected, push [CW] to toggle between CW and CW reverse mode.

• Selecting RTTY/PSK mode

- Push [RTTY/PSK] to select RTTY or PSK.
 - After RTTY or PSK is selected, push [RTTY/PSK] to toggle between RTTY and PSK.
 - After RTTY or PSK is selected, push [RTTY/PSK] for 1 sec. to toggle between RTTY and RTTY reverse, or, PSK and PSK reverse mode, respectively.

• Selecting AM/FM mode

- Push [AM/FM] to select AM or FM.
 - After AM or FM is selected, push [AM/FM] to toggle between AM and FM.

• Selecting DATA mode

- After USB, LSB, AM or FM is selected, push [DATA] to select USB data, LSB data, AM data or FM data mode, respectively.
 - After data mode is selected, push [DATA] to toggle between regular voice and data mode.
 - After data mode is selected, push [DATA] for 1 sec. to select data 1, 2 and 3 in sequence.

■ Volume setting

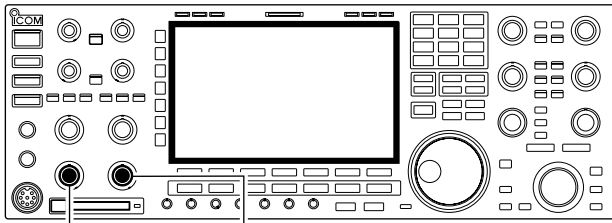

[AF] for main [AF] for sub

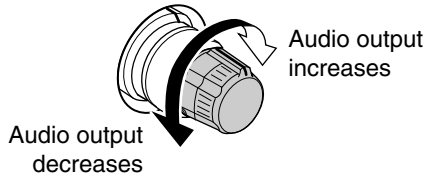

- Rotate [AF] control clockwise to increase, counterclockwise to decrease the audio output level.
 - Set a suitable audio level.

■ RF gain adjustment

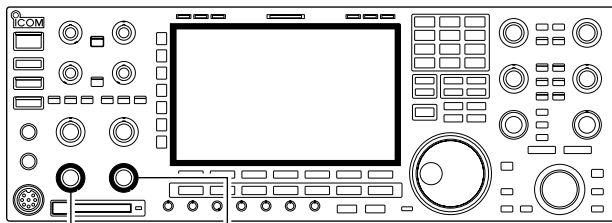

[RF] for main [RF] for sub

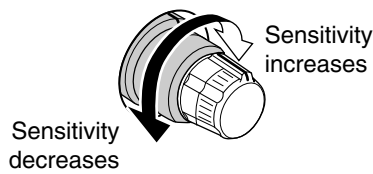

- Rotate [RF] control clockwise to increase, counterclockwise to decrease the receiver sensitivity.

■ Squelch level adjustment

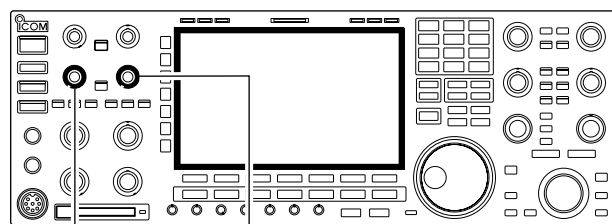

[SQL] for main [SQL] for sub

Noise squelch (Recommended level; FM mode only)

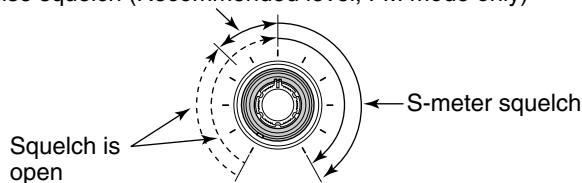

The squelch removes noise output from the speaker (closed position) when no signal is received.

- When no signal is received, rotate [SQL] control fully counterclockwise first, then rotate [SQL] clockwise to the point that the noise just disappears.

Meter indication selection

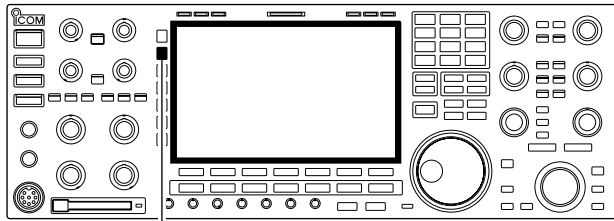

[METER]

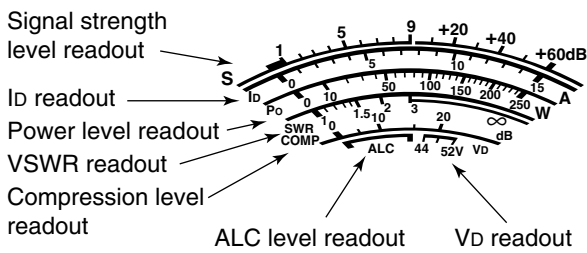

The S/RF meter indication, during transmit, can be selected from the following items as you desire.

➔ Push [METER] several times to select the desired item.

- METER Po** Indicates the RF output power in watts.
- METER SWR** Indicates the VSWR on the transmission line.
- METER ALC** Indicates the ALC level. The ALC circuit begins to activate when the RF output power reaches a preset level.
- METER COMP** Indicates the compression level when the speech compressor is in use.
- METER I_D** Indicates the drain current of the final amplifier MOS-FETs.
- METER V_D** Indicates the drain terminal voltage of the final amplifier MOS-FETs.

Multi-function digital meter

The IC-7800 can display the multi-function digital meter in the LCD display. This meter displays all transmit parameters simultaneously.

“P-HOLD” indicator

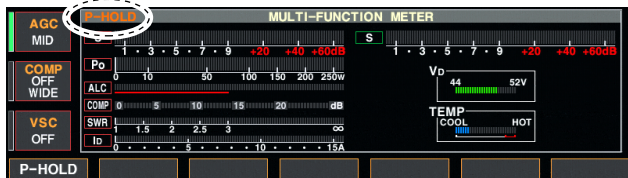

- ① Push [METER] for 1 sec. to turn the multi-function digital meter ON.
- ② Push [F-1•P-HOLD] to toggle the peak level hold function ON.
 - “P-HOLD” appears on the window title when the peak level hold function is ON.
- ③ Push [METER] for 1 sec., or push [EXIT/SET] to turn the multi-function digital meter OFF.

◇ Meter type selection

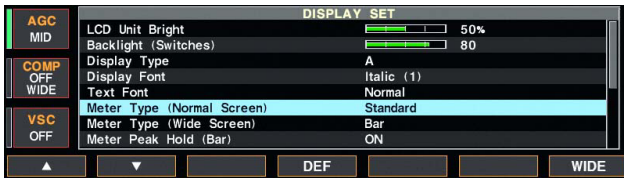
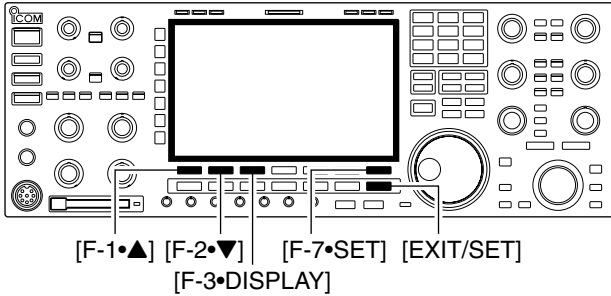

A total of 3 meter types are available in the IC-7800—Standard, Edgewise and Bar meters. Follow the instructions below for the meter type selection.

- ① Push [EXIT/SET] several times to return to normal screen, if necessary.
- ② Push [F-7•SET], then push [F-3•DISPLAY] to select display set mode.
- ③ Push [F-1•▲] or [F-2•▼] to select “Meter type (Normal Screen)” item.
- ④ Rotate main dial to select the desired meter type from “Standard,” “Edgewise” and “Bar.”
- ⑤ Push [EXIT/SET] to exit display set mode.

• Edgewise meter



• Bar meter



Basic transmit operation

Before transmitting, monitor your selected operating frequency to make sure transmitting won't cause interference to other stations on the same frequency. It's good amateur practice to listen first, and then, even if nothing is heard, ask "is the frequency in use" once or twice, before you being operating on that frequency.

Transmitting

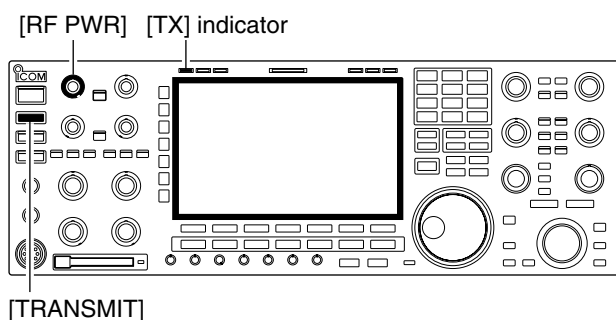

Before transmitting, monitor your selected operating frequency to make sure transmitting won't cause interference to other stations on the same frequency.

- ① Push [TRANSMIT] or [PTT] (microphone) to transmit.
 - The main band's [TX] indicator lights red.
 - When split operation is activated, the sub band's [TX] indicator lights.
- ② Push [TRANSMIT] again or release [PTT] (microphone) to return to receive.

Adjusting the transmit output power

- Rotate [RF PWR].
 - Adjustable range : 5 W to 200 W
(AM mode: 5 W to 50 W)

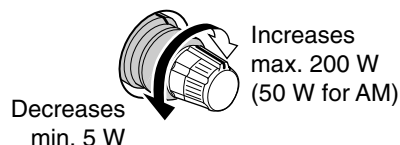

Microphone gain adjustment

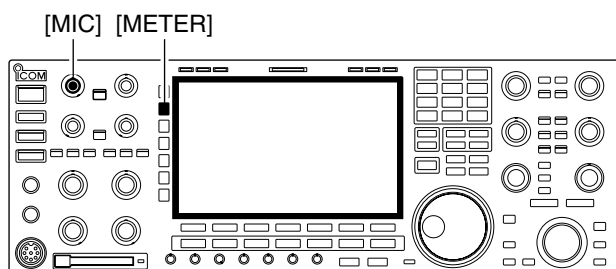

Before transmitting, monitor your selected operating frequency to make sure transmitting won't cause interference to other stations on the same frequency.

- ① Push [METER] to select the ALC meter.
- ② Push [PTT] (microphone) to transmit.
 - Talk into the microphone at your normal voice level.
- ③ While talking into the microphone, rotate [MIC] so that the ALC meter reading doesn't go outside the ALC zone. (see at left)
- ④ Release [PTT] (microphone) to return to receive.

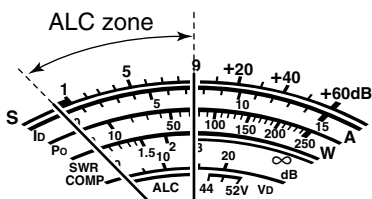

◇ Drive gain adjustment

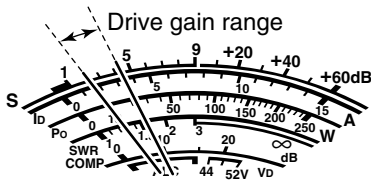
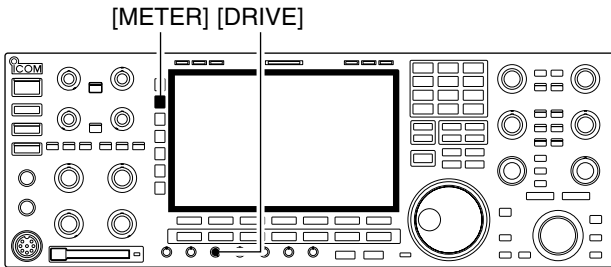

The drive gain is active for all modes except SSB without speech compressor. The [DRIVE] control adjusts the amplifying gain at the driver stage.

Before transmitting, monitor your selected operating frequency to make sure transmitting won't cause interference to other stations on the same frequency.

- ① Push [METER] to select the ALC meter.
- ② Push [PTT] (microphone; SSB with [COMP] ON, AM or FM), key down (CW) or push [TRANSMIT] (RTTY or PSK) to transmit.
- ③ While talking into the microphone, keying down or transmitting, rotate [DRIVE] so that the ALC meter reading swinging within 30 to 50% of the ALC scale. (see left)
 - Talk into the microphone at your normal voice level.
- ④ Release [PTT], stop keying or push [TRANSMIT] again to return to receive.

■ Operating SSB	4-2
◇ Convenient functions for receive	4-2
◇ Convenient functions for transmit	4-3
◇ About 5 MHz band operation (USA version only)	4-3
■ Operating CW	4-4
◇ Convenient functions for receive	4-4
◇ Convenient functions for transmit	4-5
◇ About CW reverse mode	4-5
◇ About CW pitch control	4-5
◇ CW side tone function	4-5
◇ APF (Audio Peak Filter) operation	4-6
◇ About 137 kHz band operation (Europe, UK, Italy, Spain, France versions only)	4-6
■ Electronic keyer functions	4-7
◇ Memory keyer screen	4-8
◇ Editing a memory keyer	4-9
◇ Contest number set mode	4-10
◇ Keyer set mode	4-11
■ Operating RTTY (FSK)	4-13
◇ Convenient functions for receive	4-14
◇ About RTTY reverse mode	4-14
◇ Twin peak filter	4-14
◇ Functions for the RTTY decoder indication	4-15
◇ Setting the decoder threshold level	4-15
◇ RTTY memory transmission	4-16
◇ Automatic transmission/reception setting	4-16
◇ Editing RTTY memory	4-17
◇ RTTY decode set mode	4-18
◇ Data saving	4-20
■ Operating PSK	4-21
◇ Convenient functions for receive	4-22
◇ About BPSK and QPSK mode	4-22
◇ Functions for the PSK decoder indication	4-23
◇ Setting the decoder threshold level	4-23
◇ PSK memory transmission	4-24
◇ Automatic transmission/reception setting	4-24
◇ Editing PSK memory	4-25
◇ PSK decode set mode	4-26
◇ Data saving	4-28
■ Operating AM	4-29
◇ Convenient functions for receive	4-29
◇ Convenient functions for transmit	4-30
■ Operating FM	4-31
◇ Convenient functions for receive	4-31
◇ Convenient functions for transmit	4-31
■ Repeater operation	4-32
◇ Repeater tone frequency setting	4-32
■ Tone squelch operation	4-33
■ Data mode (AFSK) operation	4-34

Operating SSB

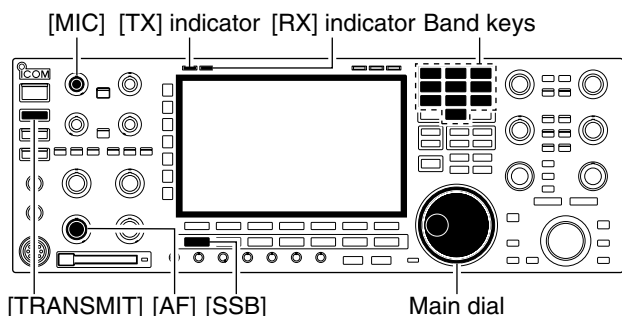

- ① Push a band key to select the desired band.
- ② Push [SSB] to select LSB or USB.
 - “USB” or “LSB” appears.
 - Below 10 MHz LSB is automatically selected; above 10 MHz USB is automatically selected.
- ③ Rotate the main dial to tune a desired signal.
 - The S-meter indicates received signal strength when signal is received.
- ④ Rotate [AF] to set audio to a comfortable listening level.
- ⑤ Push [TRANSMIT] or [PTT] (microphone) to transmit.
 - [TX] indicator lights red.
- ⑥ Speak into the microphone at your normal voice level.
 - Adjust the microphone gain with [MIC] at this step, if necessary.
- ⑦ Push [TRANSMIT] or release [PTT] (microphone) to return to receive.

Convenient functions for receive

- **Preamp** (p. 5-9)
 - ➔ Push [P.AMP] several times to set the preamp OFF, preamp 1 ON or preamp 2 ON.
 - “P.AMP1” or “P.AMP2” appears when the preamp 1 or preamp 2 is ON, respectively. (Main and sub have independent preamp controls.)
- **Attenuator** (p. 5-9)
 - ➔ Push [ATT] several times to set the attenuator in 6 dB steps.
 - Pushing [ATT] for 1 sec. to set the attenuator in 3 dB steps.
 - “ATT” and attenuation level appear when the attenuator is ON.
- **Noise blanker** (p. 5-17)
 - ➔ Push [NB] switch to turn the noise blanker ON and OFF, and then rotate [NB] control to adjust the threshold level.
 - Noise blanker indicator (above [NB] switch) lights when the noise blanker is ON.
 - Push [NB] for 1 sec. to enter noise blanker set mode.
- **Twin PBT (passband tuning)** (p. 5-12)
 - ➔ Rotate [TWIN PBT] controls (inner/outer).
 - Push [PBT CLEAR] to clear the settings.
- **Audio tone control** (p. 12-4)
 - ➔ Push [F-7•SET] then [F-1•LEVEL] to enter level set mode. Select an item with [F-1•▲]/[F-2•▼] then rotate the main dial to adjust the audio tone.
- **Noise reduction** (p. 5-18)
 - ➔ Push [NR] switch to turn the noise reduction ON and OFF.
 - Rotate [NR] control to adjust the noise reduction level.
 - Noise reduction indicator (above [NR] switch) lights when the noise reduction is ON.
- **Auto notch filter** (p. 5-19)
 - ➔ Push [NOTCH] switch to turn the auto or manual notch function ON and OFF.
 - Rotate [NOTCH] control to set the “valley” frequency for manual notch operation.
 - Notch indicator (above [NOTCH] switch) lights when either the auto or manual notch is ON.
- **AGC (auto gain control)** (p. 5-11)
 - ➔ Push [AGC] switch several times to select AGC FAST, AGC MID or AGC SLOW.
 - ➔ Push [AGC VR] to turn the AGC time constant manual setting ON and OFF.
 - Rotate [AGC] control to adjust the time constant.
- **VSC (voice squelch control)** (p. 9-3)
 - ➔ Push [VSC] to turn the VSC function ON and OFF.
 - The VSC indicator appears when the voice squelch function is set to ON.

◇ Convenient functions for transmit

- | | |
|---|--|
| <ul style="list-style-type: none"> • Speech compressor (p. 6-5) <ul style="list-style-type: none"> ➔ Push [COMP] to turn the speech compressor ON and OFF. <ul style="list-style-type: none"> • Pushing [COMP] for 1 sec. to select the compression bandwidth from wide, middle and narrow. • VOX (voice operated transmit) (p. 6-2) <ul style="list-style-type: none"> ➔ Push [VOX/BK-IN] to turn the VOX function ON and OFF. <ul style="list-style-type: none"> • “VOX” appears when the VOX function is ON. | <ul style="list-style-type: none"> • Transmit quality monitor (p. 6-4) <ul style="list-style-type: none"> ➔ Push [MONI] to turn the monitor function ON and OFF. <ul style="list-style-type: none"> • Rotate [MONI GAIN] to adjust the monitor gain. • Monitor indicator (above [MONI] switch) lights when the monitor function is ON. • Audio tone control (p. 12-4) <ul style="list-style-type: none"> ➔ Push [F-7•SET] then [F-1•LEVEL] to enter level set mode. Select an item with [F-1•▲]/[F-2•▼] then rotate the main dial to adjust the audio tone. |
|---|--|

◇ About 5 MHz band operation (USA version only)

Operation on the 5 MHz band is allowed on 5 discrete frequencies and must adhere to the following:

- USB mode
- Maximum of 50 watts ERP (Effective Radiated Power)
- 2.8 kHz bandwidth

It's your responsibility to set all controls so that transmission in this band meets the stringent conditions under which we may use these frequencies.

/// **NOTE:** We recommend that you store these frequencies, mode and filter settings into memory channels for easy recall.

/// *The FCC specifies center frequencies on the 5 MHz band. However, the IC-7800 displays carrier frequency. Therefore, tune the transceiver to 1.5 kHz below the specified FCC channel center frequency.

IC-7800 Tuning Frequency*	FCC Channel Center Frequency*
5.33050 MHz	5.33200 MHz
5.34650 MHz	5.34800 MHz
5.36650 MHz	5.36800 MHz
5.37150 MHz	5.37300 MHz
5.40350 MHz	5.40500 MHz

To assist you in operating the 5 MHz band within the rules specified by the FCC, transmission is illegal on any 5 MHz band frequency other than the 5 frequencies indicated in the table above.

Operating CW

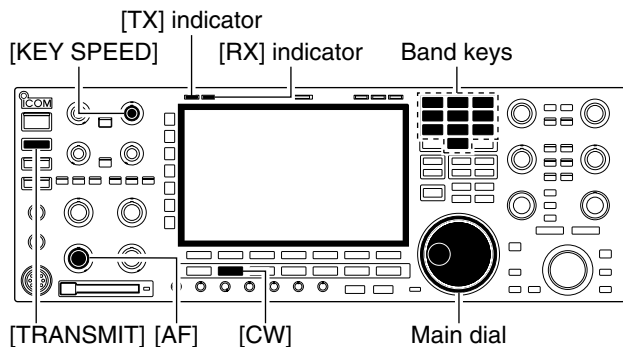

- ① Push a band key to select the desired band.
- ② Push [CW] to select CW.
 - After CW mode is selected, push [CW] to toggle between CW and CW-R modes.
 - “CW” or “CW-R” appears.
- ③ Rotate the main dial to tune a desired signal.
 - Try to match the specified signal’s tone to the side tone frequency.
 - The S-meter indicates received signal strength when signal is received.
- ④ Rotate [AF] to set audio to a comfortable listening level.
- ⑤ Push [TRANSMIT] to transmit.
 - [TX] indicator lights red.
- ⑥ Use the electric keyer or paddle to key your CW signals.
 - The power meter indicates transmitted CW output power.
- ⑦ Adjust CW speed with [KEY SPEED].
 - Adjustable within 6–60 WPM.
- ⑧ Push [TRANSMIT] to return to receive.

Convenient functions for receive

- **Preamp** (p. 5-9)
 - ➔ Push [P.AMP] several times to set the preamp OFF, preamp 1 ON or preamp 2 ON.
 - “P.AMP1” or “P.AMP2” appears when the preamp 1 or preamp 2 is ON. Main and sub have independent preamp controls.
 - **Attenuator** (p. 5-9)
 - ➔ Push [ATT] several times to set the attenuator in 6 dB steps.
 - Pushing [ATT] for 1 sec. to set the attenuator in 3 dB steps.
 - “ATT” and attenuation level appear when the attenuator is ON.
 - **Noise blanker** (p. 5-17)
 - ➔ Push [NB] switch to turn the noise blanker ON and OFF, and then rotate [NB] control to adjust the threshold level.
 - Noise blanker indicator (above [NB] switch) lights when the noise blanker is ON.
 - Push [NB] for 1 sec. to enter noise blanker set mode.
 - **Noise reduction** (p. 5-18)
 - ➔ Push [NR] switch to turn the noise reduction ON and OFF.
 - Rotate [NR] control to adjust the noise reduction level.
 - Noise reduction indicator (above [NR] switch) lights when the noise reduction is ON.
 - **Twin PBT (passband tuning)** (p. 5-12)
 - ➔ Rotate [TWIN PBT] controls (inner/outer).
 - Push [PBT CLEAR] to clear the settings.
 - **Manual notch filter** (p. 5-19)
 - ➔ Push [NOTCH] switch to turn the manual notch function ON and OFF.
 - Rotate [NOTCH] control to set the attenuating frequency.
 - Notch indicator (above [NOTCH] switch) lights when either the manual notch is ON.
 - **AGC (auto gain control)** (p. 5-11)
 - ➔ Push [AGC] switch several times to select AGC FAST, AGC MID or AGC SLOW.
 - ➔ Push [AGC VR] to turn the AGC time constant manual setting ON and OFF.
 - Rotate [AGC] control to adjust the time constant.
 - **1/4 function** (p. 3-6)
 - ➔ Push [1/4] to turn the 1/4 function ON and OFF.
 - **Auto tuning function** (p. 1-9)
 - ➔ Push [AUTO TUNE] to turn the auto tuning function ON and OFF.
 - The transceiver automatically tunes the desired signal within a ±500 Hz range.
- IMPORTANT!**
When receiving a weak signal, or receiving a signal with interference, the automatic tuning function may not tune properly, or tune onto an undesired signal.

◆ Convenient functions for transmit

- **Break-in function** (p. 6-3)
 - ➔ Push [VOX/BK-IN] several times to select the break-in OFF, semi break-in and full break-in.
 - “BK IN” or “F-BK IN” appears when the semi break-in or full break-in function is ON, respectively.

◆ About CW reverse mode

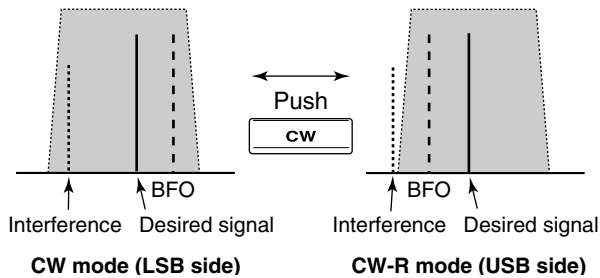

CW-R (CW Reverse) mode uses the opposite side band to receive CW signals.

Use when interfering signals are near a desired signal and you want to use CW-R to reduce the interference.

- ➔ During CW mode, push [CW] to select CW and CW-R mode.

◆ About CW pitch control

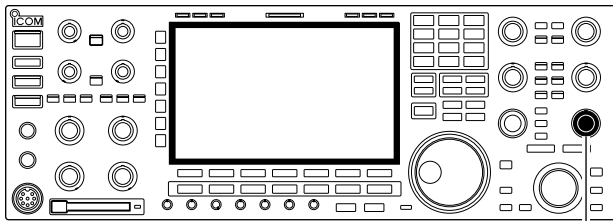

[CW PITCH]

The received CW audio pitch and CW side tone can be adjusted to suit your preference (from 300 to 900 Hz in 5 Hz steps). This does not change the operating frequency.

- ➔ Rotate [CW PITCH] to suit your preference.
 - Adjustable within 300 to 900 Hz in 5 Hz steps.

◆ CW side tone function

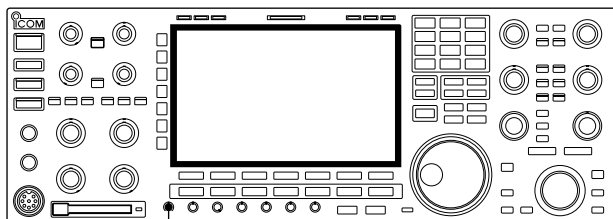

[MONI GAIN]

When the transceiver is in the receive condition (and the break-in function is OFF— p. 6-3) you can listen to the CW side tone without actually transmitting.

This allows you to match your transmit frequency exactly to another station's by matching the audio tone. You can also use the CW side tone (be sure to turn OFF break-in!) to practice CW sending. CW side tone level can be adjusted in level set mode (p. 12-5).

◇ APF (Audio Peak Filter) operation

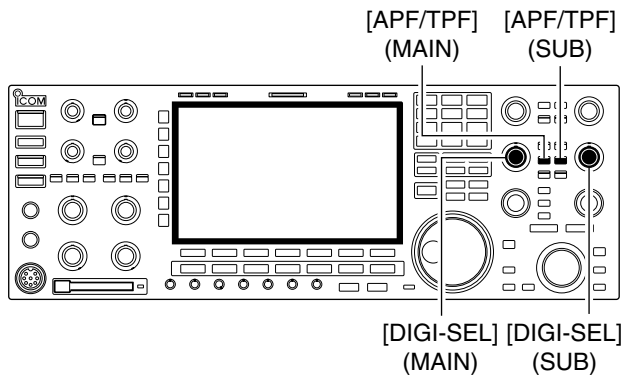

The APF changes the audio frequency response by boosting a particular frequency to enhance a desired CW signal.

The peak frequency can be adjusted with [DIGI-SEL] control when “APF” is selected for “DIGI-SEL VR Operation” in miscellaneous (others) set mode (p. 12-18).

The audio filter shape is also selectable from “SOFT” and “SHARP” in miscellaneous (others) set mode (p. 12-19).

- ① During CW mode, push [APF/TPF] to turn the audio peak filter ON and OFF.
 - “APF” appears in the display and [APF/TPF] indicator above this switch lights green.
- ② Push [APF/TPF] for 1 sec. several times to select the desired audio filter width.
 - WIDE, MID and NAR filters, or, 320, 160 and 80 Hz filters are available depending on APF type setting in miscellaneous (others) set mode.
- ③ If “APF” is selected for “DIGI-SEL VR Operation,” rotate [DIGI-SEL] control to suit your preference.

◇ About 137 kHz band operation (Europe, UK, Italy, Spain, France versions only)

137 kHz band, within the 135.7 kHz to 137.8 kHz range, operation in CW mode is optionally available with the IC-7800.

The RF signal from [X-VERTER] is used for the 137 kHz band operation, and an external amplifier unit is necessary.

See the connection diagram below for reference.

• Connection diagram for 137 kHz band operation

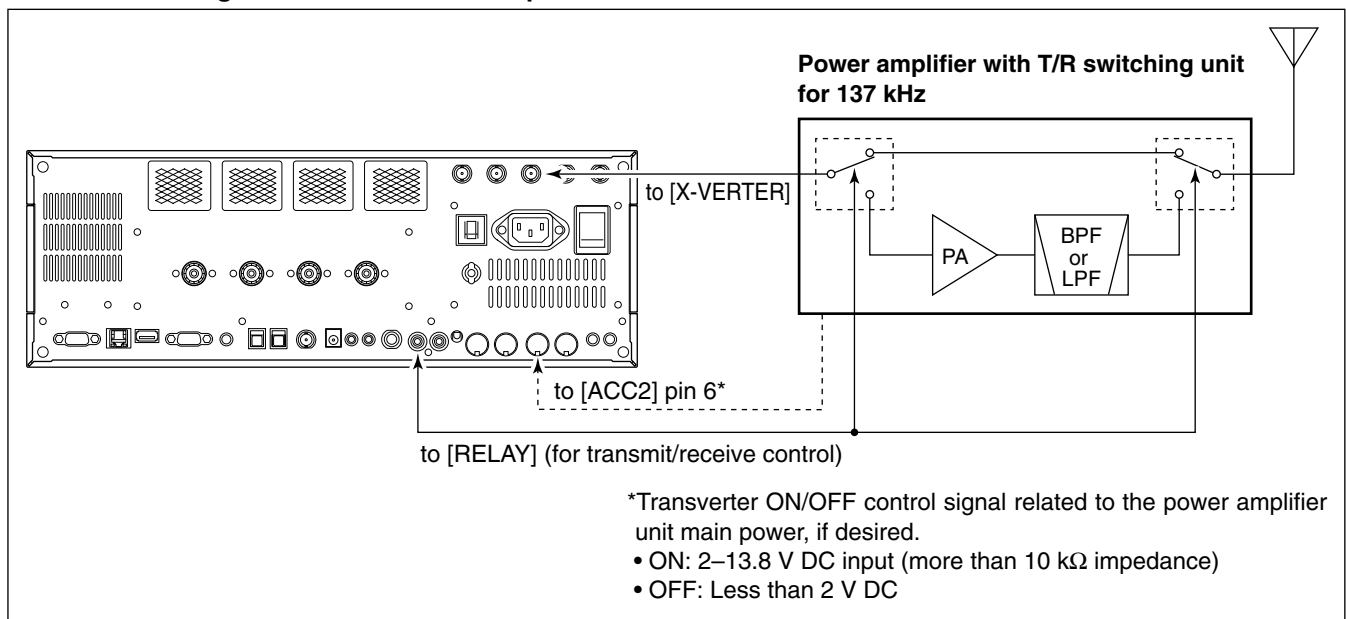

Electronic keyer functions

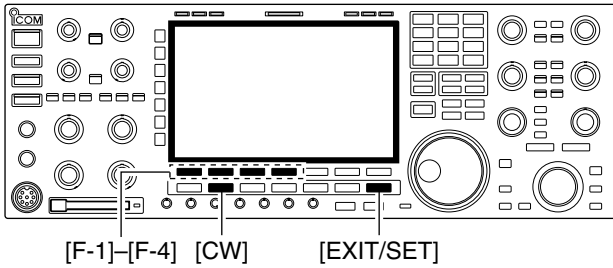

The IC-7800 has a number of convenient functions for the built-in electronic keyer.

- ① During CW mode, push [EXIT/SET] several times to normal screen, if necessary.
- ② Push [F-3•KEYER] to select memory keyer screen.
- ③ Push [EXIT/SET] to select memory keyer menu screen.
- ④ Push one of the multi-function keys ([F-1] to [F-4]) to select the desired menu. See the diagram below.
 - Push [EXIT/SET] to return to the previous display.



• Memory keyer screen (p. 4-8)



• Memory keyer edit screen (p. 4-9)

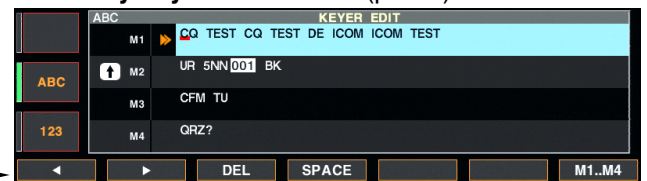

• Memory keyer menu screen

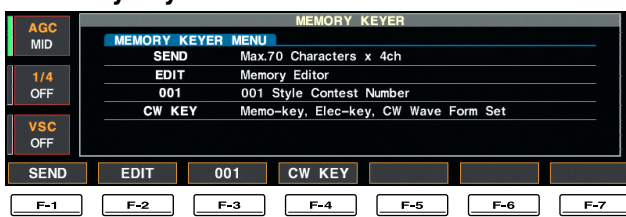

• Contest number set mode (p. 4-10)



• Keyer set mode screen (p. 4-11)



◇ Memory keyer screen

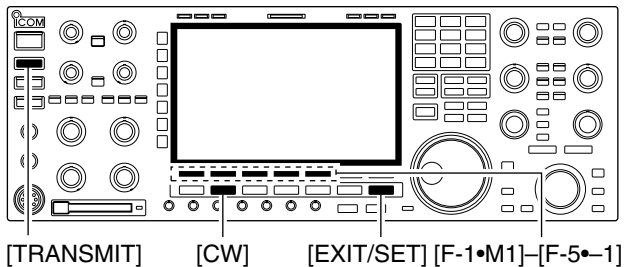

• Memory keyer screen



Pre-set characters can be sent using the keyer send menu. Contents of the memory keyer are set using the edit menu.

• Transmitting

- ① During CW mode operation, push [F-3•KEYER] to select memory keyer screen.
- ② Push [TRANSMIT] to set the transceiver to transmit, or set the break-in function ON (p. 6-3).
- ③ Push one of the function keys ([F-1•M1] to [F-4•M4]) to send the contents of the memory keyer.
 - Pushing a function key for 1 sec. repeatedly sends the contents; push any function key to cancel the transmission.
 - The contest serial number counter is incremented each time the contents are sent.
 - Push [F-5•-1] to reduce the contest serial number count by 1 when resending contents to unanswered calls.

/// **For your information**

When an external keypad is connected to [EXT KEYPAD] connector on the rear panel, the programmed contents, M1—M4, can be transmitted without selecting the memory keyer screen. See p. 2-6 for details.

- ④ Push [EXIT/SET] twice to return to normal screen.

◇ Editing a memory keyer

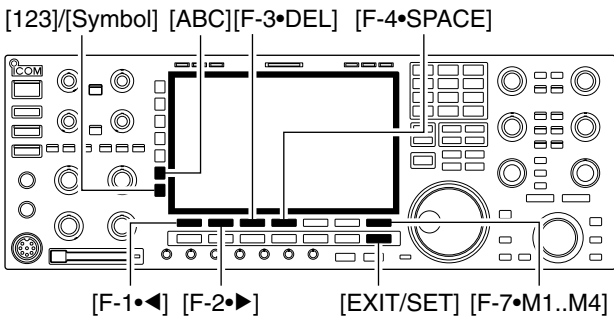

• Memory keyer edit screen

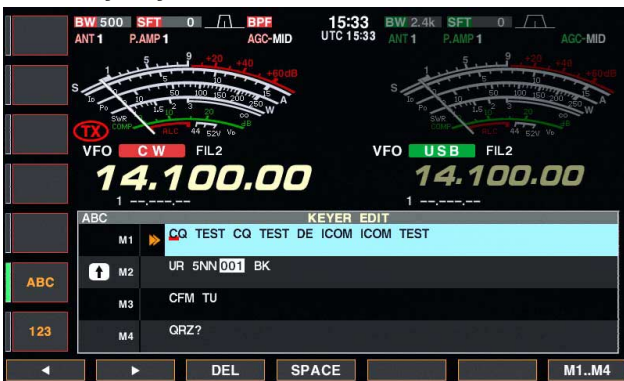

• Example— entered “QSL TU DE JA3YUA TEST” into memory keyer channel 3



• Pre-programmed contents

CH	Contents
M1	CQ TEST CQ TEST DE ICOM ICOM TEST
M2	UR 5NN* BK
M3	CFM TU
M4	QRZ?

The contents of the memory keyer memories can be set using the memory keyer edit menu. The memory keyer can memorize and re-transmit 4 CW key codes for often-used CW sentences, contest serial numbers, etc. Total capacity of the memory keyer is 70 characters per memory channel.

• Programming contents

- ① During CW mode operation, push [F-3]•KEYER to select memory keyer screen.
- ② Push [EXIT]•SET to select memory keyer menu, then push [F-2]•EDIT to select keyer edit screen.
 - Memory keyer contents of Channel 1 (M1) is selected.
- ③ Push [F-7]•M1..M4 several times to select the desired memory keyer channel to be edited.
- ④ Push [ABC] or [123] or [Symbol] to select the character group, then rotate the main dial to select the character, or push the keypad for number input.
 - [Symbol] appears when [123] is pushed when “123” character group is selected.
 - Selectable characters (using the main dial);

Key selection	Editable characters
ABC	A to Z (capital letters)
123	0 to 9 (numbers)
Symbol	/ ? ^ . , @ *

NOTE:

- “^” is used to transmit a following word with no space such as AR. Put “^” before a text string such as ^AR, and the string “AR” is sent with no space.
- “*” is used to insert the CW contest serial number. The serial number automatically increments by 1. This function is only available for one memory keyer channel at a time. Memory keyer channel M2 used “*” by default.

✓ For your convenience

When a PC keyboard is connected to [KEYBOARD] connector on the rear panel, the memory keyer contents can also be edited from the keyboard.

- ⑤ Push [F-1]•◀ or [F-2]•▶ to move the cursor backwards or forwards, respectively.
 - Pushing [F-3]•DEL deletes a character and [F-4]•SPACE inserts a space.
- ⑥ Repeat steps ④ and ⑤ to input the desired characters.
- ⑦ Push [EXIT/SET] twice to return normal screen.

◇ Contest number set mode

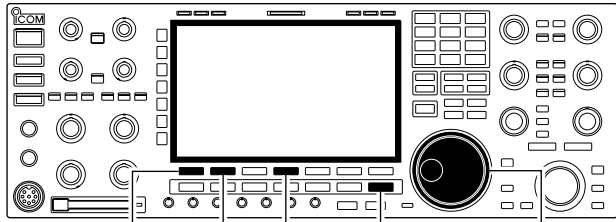

[F-1•▲] [F-2•▼] [F-4•DEF] [EXIT/SET] Main dial

This menu is used to set the contest (serial) number and count up trigger, etc.

• Setting contents

- ① During CW mode operation, push [F-3•KEYER] to select memory keyer screen.
- ② Push [EXIT•SET] to select memory keyer menu, then push [F-3•001] to select contest serial number set mode.
- ③ Push [F-1•▲] or [F-2•▼] to select the desired set item.
- ④ Set the desired condition using the main dial.
 - Push [F-4•DEF] for 1 sec. to select the default condition or value.
- ⑤ Push [EXIT/SET] twice to normal screen.

• Contest number set mode screen



Number Style	Normal
This item sets the numbering system used for contest (serial) numbers— normal or short morse numbers.	<ul style="list-style-type: none"> • Normal : Does not use short morse numbers (default) • 190→ANO : Sets 1 as A, 9 as N and 0 as O. • 190→ANT : Sets 1 as A, 9 as N and 0 as T. • 90→ NO : Sets 9 as N and 0 as O. • 90→ NT : Sets 9 as N and 0 as T.

Count Up Trigger	M2
This selects which of the four memories will contain the contest serial number exchange. The count-up trigger allows the serial number to automatically incremented after each complete serial number exchange is sent.	<ul style="list-style-type: none"> • M1, M2, M3 and M4 can be set. (default: M2)

Present Number	001
This item shows the current number for the count-up trigger channel set above.	<ul style="list-style-type: none"> • Rotate the main dial to change the number, or push [F-3•001CLR] for 1 sec. to reset the current number to 001.

◇ **Keyer set mode**

This set mode is used to set the memory keyer repeat time, dash weight, paddle specifications, keyer type, etc.

• **Setting contents**

- ① During CW mode operation, push [F-3•KEYER] to select memory keyer screen.
- ② Push [EXIT•SET] to select memory keyer menu, then push [F-4•CW KEY] to select keyer set mode.
- ③ Push [F-1•▲] or [F-2•▼] to select the desired set item.
- ④ Set the desired condition using the main dial.
 - Push [F-4•DEF] for 1 sec. to select the default condition or value.
- ⑤ Push [EXIT/SET] twice to normal screen.

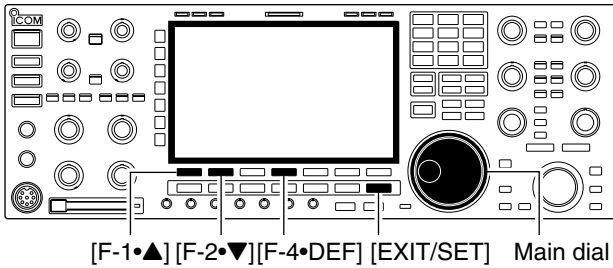

• **Keyer set mode screen**



Keyer Repeat Time	2s
When sending CW using the repeat timer, this item sets the time between transmission.	• 1 to 60 sec. in 1 sec. steps can be selected. (default: 2 sec.)

Dot/Dash Ratio	1:1:3.0
This item sets the dot/dash ratio.	• 1:1:2.8 to 1:1:4.5 (in 0.1 steps) can be selected. (default: 1:1:3.0)
Keying weight example: Morse code "K"	
*SPACE and DOT length can be adjusted with [KEY SPEED] only.	

Rise Time	4ms
This item sets the rise time of the transmitted CW envelope.	• 2, 4, 6 or 8 msec. can be selected. (default: 4 msec.)
<p>• About rise time</p>	

to be continued...

◇ Keyer set mode (continued)

Paddle Polarity	Normal
This item sets the paddle polarity.	• Normal and reverse polarity can be selected.

Keyer Type	ELEC-KEY
This item selects the keyer type for [ELEC-KEY] connector on the front panel.	• ELEC-KEY, BUG-KEY and Straight key can be selected. (default: ELEC-KEY)

MIC Up/Down Keyer	OFF
This item allows you to set the microphone [UP]/[DN] keys to be used as a paddle.	<ul style="list-style-type: none">• ON : [UP]/[DN] switches can be used for CW.• OFF : [UP]/[DN] switches cannot be used for CW. <p>NOTE: When “ON” is selected, the frequency and memory channel cannot be changed using the [UP]/[DN] switches.</p>

■ Operating RTTY (FSK)

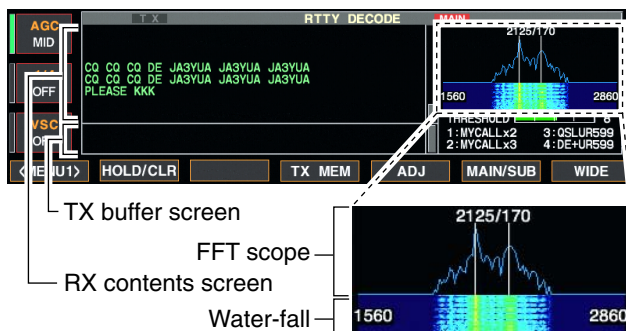
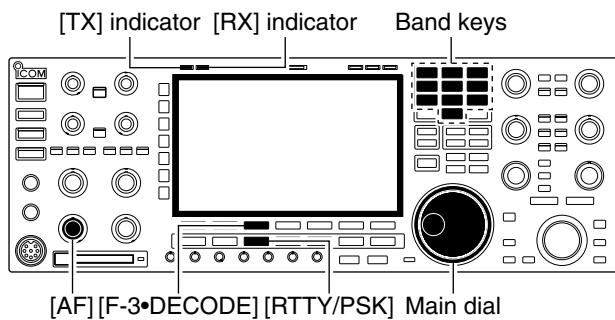

A DSP-based high-quality Baudot RTTY encoder/decoder is built-in to the IC-7800. When connecting a PC keyboard (p. 2-6), RTTY operation can be performed without an external RTTY terminal, TNC or PC.

If you would rather use your RTTY terminal or TNC, consult the manual that comes with the RTTY terminal or TNC.

- ① Push a band key to select the desired band.
- ② Push [RTTY/PSK] to select RTTY.
 - After RTTY mode is selected, push [RTTY/PSK] for 1 sec. to toggle between RTTY and RTTY-R modes.
 - “RTTY” or “RTTY-R” appears.
- ③ Push [F-3•DECODE] to display the decoder screen.
 - The IC-7800 has a built-in Baudot decoder.
- ④ To tune the desired signal, aim for a symmetrical wave form and ensure the peak points align with the mark (2125 Hz) and shift (170 Hz) frequency lines in the FFT scope.
 - The S-meter indicates received signal strength when signal is received.
- ⑤ Press [F12] on the connected keyboard to transmit.
 - [TX] indicator lights red.
- ⑥ Type from the keyboard to enter the contents that you want to transmit.
 - The typewritten contents are indicated in the TX buffer screen and transmitted immediately.
 - The text color will be changed when transmitted.
 - Press one of [F1]–[F8] to transmit the TX memory contents.
- ⑦ Press [F12] on the keyboard to return to receive.

✓ For your convenience

The transmission contents can be typed before being transmitted.

- ① Perform the steps ① to ④ above.
- ② Type from the connected keyboard to enter the message that you want to transmit.
 - The typewritten contents are indicated in the TX buffer screen.
- ③ Press [F12] of the connected keyboard to transmit the typewritten contents.
 - The color of displayed text, in the TX buffer screen, will be changed when transmitted.
 - To cancel the transmission, press [F12] twice.
- ④ Press [F12] of the keyboard to return to receive.

◇ Convenient functions for receive

- **Preamp** (p. 5-9)
 - ➔ Push [P.AMP] several times to set the preamp OFF, preamp 1 ON or preamp 2 ON.
 - “P.AMP1” or “P.AMP2” appears when the preamp 1 or preamp 2 is ON. Main and sub have independent preamp controls.
- **Attenuator** (p. 5-9)
 - ➔ Push [ATT] several times to set the attenuator in 6 dB steps.
 - Pushing [ATT] for 1 sec. to set the attenuator in 3 dB steps.
 - “ATT” and attenuation level appear when the attenuator is ON.
- **Noise blanker** (p. 5-17)
 - ➔ Push [NB] switch to turn the noise blanker ON and OFF, and then rotate [NB] control to adjust the threshold level.
 - Noise blanker indicator (above [NB] switch) lights when the noise blanker is ON.
 - Push [NB] for 1 sec. to enter noise blanker set mode.
- **Twin PBT (passband tuning)** (p. 5-12)
 - ➔ Rotate [TWIN PBT] controls (inner/outer).
 - Push [PBT CLEAR] to clear the settings.
- **Noise reduction** (p. 5-18)
 - ➔ Push [NR] switch to turn the noise reduction ON and OFF.
 - Rotate [NR] control to adjust the noise reduction level.
 - Noise reduction indicator (above [NR] switch) lights when the noise reduction is ON.
- **Auto notch filter** (p. 5-19)
 - ➔ Push [NOTCH] switch to turn the manual notch function ON and OFF.
 - Rotate [NOTCH] control to set the attenuating frequency.
 - Notch indicator (above [NOTCH] switch) lights when either the manual notch is ON.
- **AGC (auto gain control)** (p. 5-11)
 - ➔ Push [AGC] switch several times to select AGC FAST, AGC MID or AGC SLOW.
 - Push [AGC VR] to turn the AGC time constant manual setting ON and OFF.
 - Rotate [AGC] control to adjust the time constant.
- **1/4 function** (p. 3-6)
 - ➔ Push [1/4] to turn the 1/4 function ON and OFF.

◇ About RTTY reverse mode

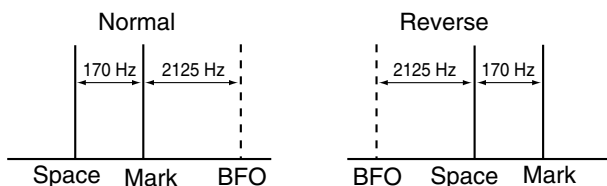

Received characters are occasionally garbled when the received signal has Mark and Space tones reversed. This reversal can be caused by incorrect TNC connections, setting, commands, etc. To receive reversed RTTY signals correctly, select RTTY-R mode.

- ➔ During RTTY mode, push [RTTY/PSK] for 1 sec. to select RTTY and RTTY-R mode.

◇ Twin peak filter



The twin peak filter changes audio frequency response by boosting the mark and space frequencies (2125 and 2295 Hz) for better reception of RTTY signals.

- ➔ During RTTY mode, push [APF/TPF] to turn the twin peak filter ON and OFF.
 - “TPF” appears in the LCD and the [APF/TPF] indicator above this switch lights green while the filter is in use.

NOTE: When the twin peak filter is in use, the received audio output may increase. This is a normal, not a malfunction.

◆ Functions for the RTTY decoder indication

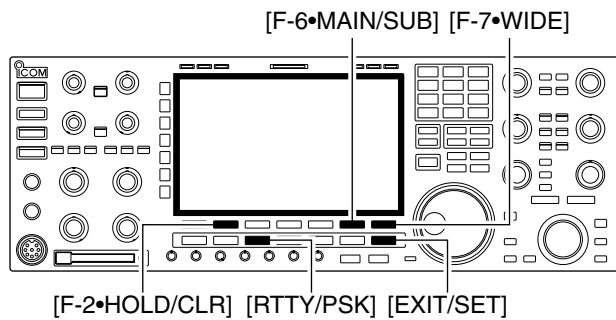

• Wide screen indication



◆ Setting the decoder threshold level



- ① Push a band key to select the desired band.
- ② Push [RTTY/PSK] to select RTTY.
 - After RTTY mode is selected, push [RTTY/PSK] for 1 sec. to toggle between RTTY and RTTY-R modes.
 - “RTTY” or “RTTY-R” appears.
- ③ Push [F-3•DECODE] to display the decoder screen.
 - When tuned into an RTTY signal, decoded characters are displayed in the RX contents screen.
- ④ Push [F-2•HOLD/CLR] to freeze the current screen.
 - “HOLD” appears while the function is in use.
 - Push [F-2•HOLD/CLR] again to release the function.
- ⑤ Push [F-2•HOLD/CLR] for 1 sec. to clear the displayed characters.
 - “HOLD” indicator disappears at the same time when the hold function is in use.
- ⑥ Push [F-7•WIDE] to toggle the RTTY decode screen size from normal and wide.
 - S/RF meter type during wide screen indication can be selected in display set mode. (pgs. 3-11, 12-11)
- ⑦ Push [F-6•MAIN/SUB] to toggle the MAIN and SUB band for decode operation.
 - Dualwatch function (p. 5-16) should be ON when SUB band is selected for decode operation.
- ⑧ Push [EXIT/SET] to close the RTTY decode screen.

Adjust the RTTY decoder threshold level if some characters are displayed when no signal is received.

- ① Select the RTTY decoder screen as described above.
- ② Push [F-5•ADJ] to select the threshold level setting condition.
- ③ Rotate the main dial to adjust the RTTY decoder threshold level.
 - Push [F-6•DEF] for 1 sec. to select the default setting.
- ④ Push [F-5•ADJ] to exit from the threshold level setting condition.

▨ The UnShift On Space (USOS) function and new line code can be set in the RTTY set mode. (p. 4-18)

◇ RTTY memory transmission

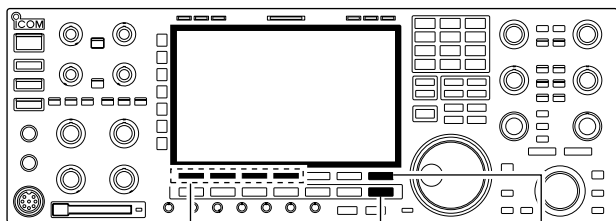

[F-1•RT1]–[F-4•RT4] [EXIT/SET] [F-7•1–4/5–8]
[F-1•RT5]–[F-4•RT8]

RTTY MEMORY				
AGC MID	RT1	MYCALLx2	„DE ICOM ICOM K„	AUTO TX/RX
1/4 OFF	RT2	MYCALLx3	„DE ICOM ICOM ICOM K„	AUTO TX/RX
	RT3	QSLUR599	„QSL UR 599–599 BK„	AUTO TX/RX
VSC OFF	RT4	DE+UR599	„QSL DE ICOM ICOM UR 599–599 BK„	AUTO TX/RX
	RT1	RT2	RT3	RT4
			EDIT	1–4/5–8

Pre-set characters can be sent using the RTTY memory. Contents of the memory are set using the edit menu.

- ① During RTTY mode operation, push [F-3•DECODE] to select RTTY decode screen.
- ② Push [F-4•TX MEM] to select RTTY memory screen.
- ③ Push [F-7•1–4/5–8] to select memory bank then push one of the function keys ([F-1•RT1] to [F-4•RT4] or [F-1•RT5] to [F-4•RT8]).
 - When no keyboard is connected, the selected memory contents will be transmitted immediately.
 - When a keyboard is connected, the memory contents will be transmitted immediately when function key is pushed, or transmitted after [F12] on the connected keyboard is pressed, depending on auto transmission/reception setting (see below).
 - The transmission date, time, reception date and/or time may be displayed in RX contents screen, depending on setting.

◇ Automatic transmission/reception setting

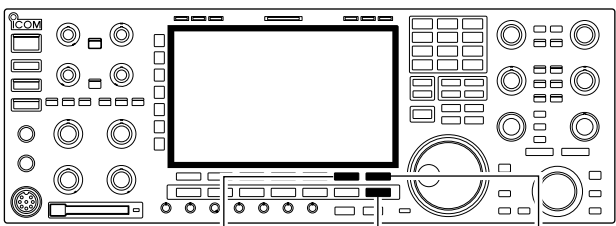

[F-6•AUTO TX] [EXIT/SET] [F-7•RT1..RT8]

RTTY MEMORY EDIT				
ABC	RT1	MYCALLx2	„DE ICOM ICOM K„	AUTO TX/RX
	RT2	MYCALLx3	„DE ICOM ICOM ICOM K„	AUTO TX/RX
	RT3	QSLUR599	„QSL UR 599–599 BK„	AUTO TX/RX
	RT4	DE+UR599	„QSL DE ICOM ICOM UR 599–599 BK„	AUTO TX/RX
		DEL	SPACE	AUTO TX
				RT1..RT8

- ① During RTTY mode operation, push [F-3•DECODE] to select RTTY decode screen.
- ② Push [F-4•TX MEM] to select RTTY memory screen, then push [F-6•EDIT] to select RTTY memory edit screen.
 - RTTY memory contents of the Channel 1 (RT1) is selected.
- ③ Push [F-7•RT1..RT8] several times to select the desired RTTY memory.
- ④ Push [F-6•AUTO TX] several times to select the desired condition as follow.
 - AUTO TX/RX : Automatically transmits the selected memory and returns to receive after the transmission.
 - AUTO TX : Automatically transmits the selected memory. To return to receive, press [F12] on the keyboard.
 - AUTO RX : Press [F12] on the keyboard to transmit the selected memory. Automatically returns to receive after the transmission.
 - No indication : Press [F12] on the keyboard to transmit the selected memory and press [F12] again to return to receive.
- ⑤ Push [EXIT/SET] to exit RTTY memory edit condition.

NOTE: The transceiver always functions as the “AUTO TX/RX” setting when no keyboard is connected.

◇ Editing RTTY memory

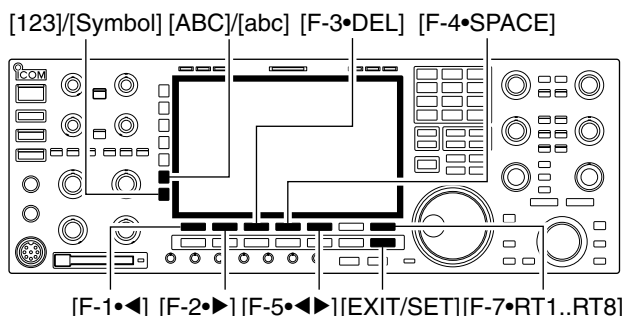

• RTTY memory edit screen



• Pre-programmed contents

CH	Name	Contents
RT1	MYCALLx2	└DE ICOM ICOM K┘
RT2	MYCALLx3	└DE ICOM ICOM ICOM K┘
RT3	QSLUR599	└QSL UR 599-599 BK┘
RT4	DE+UR599	└QSL DE ICOM ICOM UR 599-599 BK┘
RT5	73 GL SK	└73 GL SK┘
RT6	CQ CQ CQ	└CQ CQ CQ DE ICOM ICOM ICOM K┘
RT7	RIG&ANT	└MY TRANSCEIVER IS IC-7800 & ANTENNA IS A 3-ELEMENT TRIBAND YAGI.┘
RT8	EQUIP.	└MY RTTY EQUIPMENT IS INTERNAL FSK UNIT & DEMODULATOR OF THE IC-7800.┘

The contents of the RTTY memories can be set using the memory edit menu. The memory can store and re-transmit 8 RTTY message for often-used RTTY information. Total capacity of the memory is 70 characters per memory channel.

• Programming contents

- ① During RTTY mode operation, push [F-3•DECODE] to select RTTY decode screen.
- ② Push [F-4•TX MEM] to select RTTY memory screen, then push [F-6•EDIT] to select RTTY memory edit screen.
 - RTTY memory contents of the Channel 1 (RT1) is selected.
- ③ Push [F-7•RT1..RT8] to several times to select the desired RTTY memory channel to be edited.
- ④ Push [F-5•◀ ▶] to select the edit item between memory contents and memory name.
 - [abc] appears when [ABC] is pushed when “ABC” character group is selected, and [Symbol] appears when [123] is pushed when “123” character group is selected.
 - Selectable characters (with the main dial);

Key selection	Editable characters
	A to Z (capital letters)
	a to z (small letters) (selectable for memory name only)
	0 to 9 (numbers)
	! # \$ % & ¥ ? “ ‘ ` ^ + - * / . , ; = < > () [] { } _ ~ @ (For the memory contents setting, ! \$ & ? “ ‘ - / . , ; ; () ┘ are selectable.)

✓ For your convenience

When a PC keyboard is connected to [KEYBOARD] connector on the rear panel, the RTTY memory contents can also be edited from the keyboard.

- ⑥ Push [F-1•◀] or [F-2•▶] to move the cursor backwards or forwards, respectively.
 - Pushing [F-3•DEL] deletes a character and [F-4•SPACE] inserts a space.
- ⑦ Repeat steps ⑤ and ⑥ to input the desired characters.
- ⑧ Push [EXIT/SET] to set the contents and exit RTTY memory edit screen.

◇ RTTY decode set mode

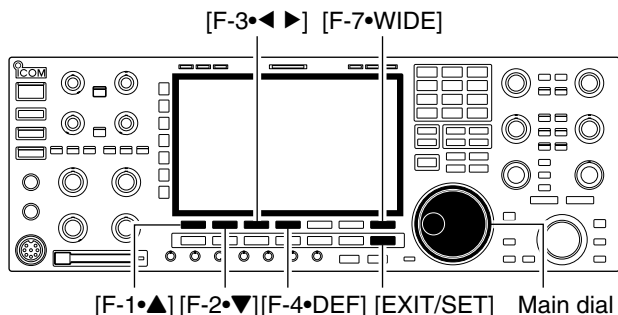

This set mode is used to set the decode USOS function, time stamp setting, etc.

• Setting contents

- ① During RTTY mode operation, push [F-3•DECODE] to select RTTY decode screen.
- ② Push [F-1•<MENU2>] to select RTTY decode menu 2, then push [F-6•SET] to select RTTY decode set mode.
 - Push [F-7•WIDE] to toggle the screen size from normal and wide.
- ③ Push [F-1•▲] or [F-2•▼] to select the desired set item.
- ④ Set the desired condition using the main dial.
 - Push [F-4•DEF] for 1 sec. to select a default condition or value.
 - Push [F-3•◀▶] to select the set contents for some items.
- ⑤ Push [EXIT/SET] to exit from set mode.

• RTTY decode set mode screen



RTTY FFT Scope Averaging	OFF
Set the FFT scope waveform averaging function from 2 to 4 and OFF. (default: OFF)	<p>Recommendation! If you use the FFT scope waveform for tuning, use the default or smaller number setting is recommended.</p>



RTTY FFT Scope Waveform Color	
Set the color for the FFT scope waveform.	<ul style="list-style-type: none"> • The color is set in RGB format. • The set color is indicated in the box beside the RGB scale.
<ul style="list-style-type: none"> • Push [F-3•◀▶] to select R (Red), G (Green) and B (Blue), and then rotate the main dial to set the ratio from 0 to 255. 	

RTTY Decode USOS	ON
Turn the letter code decoding after receiving a “space” (USOS; UnShift On Space function) capability ON and OFF.	<ul style="list-style-type: none"> • ON : Decode as letter code. • OFF : Decode as character code.

RTTY Decode New Line Code	CR,LF,CR+LF
Selects the new line code of the internal RTTY decoder. CR: Carriage Return, LF: Line Feed	<ul style="list-style-type: none"> • CR,LF,CR;LF : Makes new line with any codes. • CR+LF : Makes new line with CR+LF code only.

RTTY Diddle	BLANK
Selects the diddle condition.	<ul style="list-style-type: none"> • BLANK : Transmits blank code during no code transmission. • LTRS : Transmits letter code during no code transmission. • OFF : Turns the diddle function OFF.

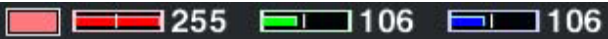
◇ RTTY decode set mode (continued)

RTTY TX USOS Explicitly inserts the FIGS character even though it is not required by the receiving station.	ON <ul style="list-style-type: none"> • ON : Inserts FIGS. • OFF : Does not insert FIGS.
RTTY Time Stamp Turn the time stamp (date, transmission or reception time) indication ON and OFF.	ON <ul style="list-style-type: none"> • ON : Displays the time stamp. • OFF : No time stamp indication.
RTTY Auto CR+LF by TX Selects the automatic new line code (CR+LF) transmission capability.	ON <ul style="list-style-type: none"> • ON : Transmits CR+LF code once. • OFF : Transmits no CR+LF code.
RTTY Time Stamp (Time) Selects the clock indication for time stamp usage. NOTE: The time won't be displayed when "OFF" is selected in "RTTY Time Stamp" as above.	Local <ul style="list-style-type: none"> • Local : Selects the time that set in "Time (Now)." • UTC* : Selects the time that set in "CLOCK2." <p>*The name of choice may differ according to "CLOCK2 Name" setting (p, 11-2). "UTC" is the default name of CLOCK2.</p>
RTTY Time Stamp (Frequency) Selects the operating frequency indication for time stamp usage. NOTE: The frequency won't be displayed when "OFF" is selected in "RTTY Time Stamp" as above.	OFF <ul style="list-style-type: none"> • ON : Displays the operating frequency. • OFF : No operating frequency display.
RTTY Font Color (Receive) Set the text color for received characters. <ul style="list-style-type: none"> • The color is set in RGB format. • The set color is indicated in the box beside the RGB scale. 	 <ul style="list-style-type: none"> • Push [F-3•◀▶] to select R (Red), G (Green) and B (Blue), and then rotate the main dial to set the ratio from 0 to 255.
RTTY Font Color (Transmit) Set the text color for transmitted characters. <ul style="list-style-type: none"> • The color is set in RGB format. • The set color is indicated in the box beside the RGB scale. 	 <ul style="list-style-type: none"> • Push [F-3•◀▶] to select R (Red), G (Green) and B (Blue), and then rotate the main dial to set the ratio from 0 to 255.
RTTY Font Color (Time Stamp) Set the text color for time stamp indication. <ul style="list-style-type: none"> • The color is set in RGB format. • The set color is indicated in the box beside the RGB scale. 	 <ul style="list-style-type: none"> • Push [F-3•◀▶] to select R (Red), G (Green) and B (Blue), and then rotate the main dial to set the ratio from 0 to 255.
RTTY Font Color (TX Buffer) Set the text color in the TX buffer screen. <ul style="list-style-type: none"> • The color is set in RGB format. • The set color is indicated in the box beside the RGB scale. 	 <ul style="list-style-type: none"> • Push [F-3•◀▶] to select R (Red), G (Green) and B (Blue), and then rotate the main dial to set the ratio from 0 to 255.

◇ Data saving

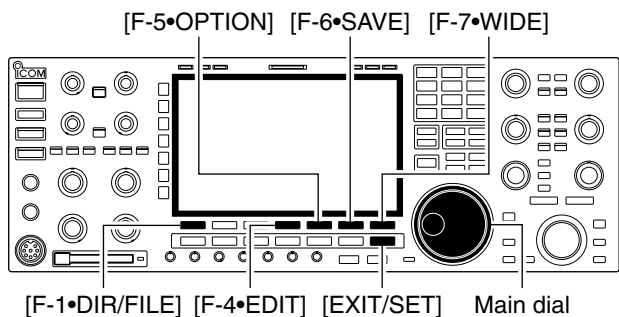

• Decode file save screen

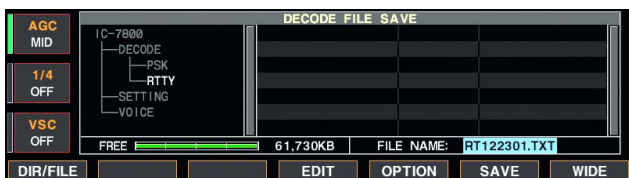

• Decode file save screen— file name edit



• Save option screen

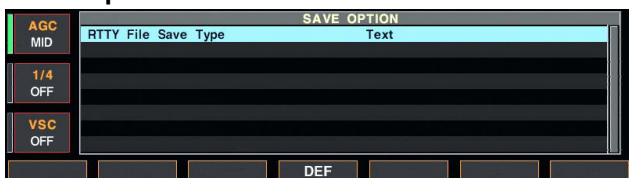

The contents of the RTTY memory and received signal can be saved into the CF memory card.

- ① During RTTY decode screen indication, push [F-1•<MENU1>] to select RTTY decode menu 2.
- ② Push [F-5•SAVE] to select decode file save screen.
- ③ Change the following conditions if desired.

• File name:

- ① Push [F-4•EDIT] to select file name edit condition.
 - Push [F-1•DIR/FILE] several times to select the file name, if necessary.
- ② Push [ABC], [123] or [Symbol] to select the character group, then rotate the main dial to select the character.
 - [ABC] : A to Z (capital letters); [123]: 0 to 9 (numerals); [Symbol]: ! # \$ % & ' ` ^ + - = () [] { } _ ~ @ can be selected.
 - Push [F-1•◀] to move the cursor left, push [F-2•▶] to move the cursor right, [F-3•DEL] delete a character and push [F-4•SPACE] to insert a space.
- ③ Push [EXIT/SET] to set the file name.

• File format

- ① Push [F-5•OPTION] to enter save option screen.
- ② Rotate the main dial to select the saving format from Text to HTML.
 - “Text” is the default setting.
 - Push [F-4•DEF] for 1 sec. to select the default setting.
- ③ Push [EXIT/SET] to return to the previous indication.

• Saving location

- ① Push [F-1•DIR/FILE] to select tree view screen.
- ② Select the desired directory or folder in the CF memory card.
 - Push [F-4•◀▶] to select the upper directory.
 - Push [F-2•▲] or [F-3•▼] to select folder in the same directory.
 - Push [F-4•◀▶] for 1 sec. to select a folder in the directory.
 - Push [F-5•REN/DEL] to rename the folder.
 - Push [F-5•REN/DEL] for 1 sec. to delete the folder.
 - Push [F-6•MAKE] for 1 sec. to making a new folder. (Edit the name with the same manner as the “• File name” above.)
- ③ Push [F-1•DIR/FILE] twice to select the file name.
- ④ Push [F-6•SAVE].
 - After the saving is completed, returns to RTTY decode menu 2 automatically.

✓ For your convenience!

Two formats, Text and HTML, are available for storage of data to your PC.

Operating PSK

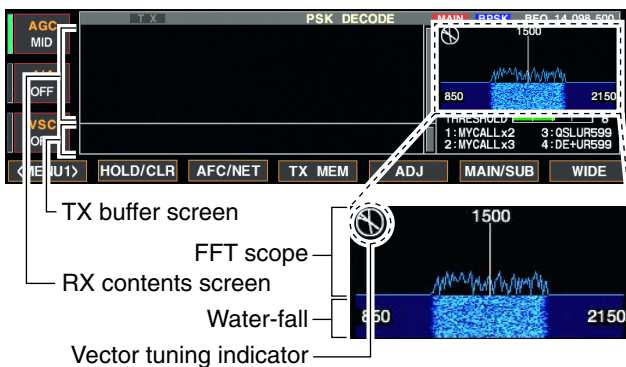
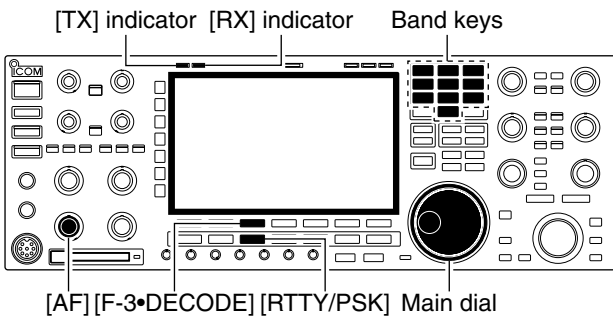

Vector tuning indicator indication example

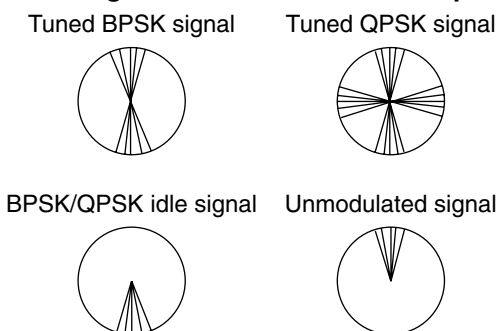

A high-quality DSP-based PSK31 encoder/decoder is built-in to the IC-7800. When connecting a PC keyboard (p. 2-6), PSK31 operation can be performed without PSK software installed on your PC.

If desired, you can also use your PSK software; consult the manual that comes with the software.

- ① Push a band key to select the desired band.
- ② Push [RTTY/PSK] to select PSK.
 - After PSK mode is selected, push [RTTY/PSK] for 1 sec. to toggle between PSK and PSK-R modes.
 - “PSK” or “PSK-R” appears.
- ③ Push [F-3•DECODE] to displays the decoder screen.
 - The IC-7800 has a built-in PSK31 decoder.
- ④ Tune the desired signal with the main dial.
 - The signal is properly tuned when the radiated lines in the vector tuning indicator narrow, as show in the example below.
 - The radiated lines in the vector tuning indicator may be displayed sporadically.
 - When a PSK signal is received, the water-fall display is activated.
 - The water-fall display shows the signal condition within the passband and a vertical line appears when a PSK signal is received.
- ⑤ Press [F12] of the connected keyboard to transmit.
 - [TX] indicator lights red.
- ⑥ Type from the connected keyboard to enter the message that you want to transmit.
 - The typewritten contents are indicated in the TX buffer screen and transmitted immediately.
 - The text color will be changed when transmitted.
 - Press one of [F1]–[F8] to transmit the TX memory contents.
- ⑦ Press [F12] of the keyboard to return to receive.

✓ For your convenience

The transmission contents can be typed before being transmitted.

- ① Perform the steps ① to ④ above.
- ② Type from the connected keyboard to enter the message that you want to transmit.
 - The message is shown in the TX buffer screen.
- ③ Press [F12] of the connected keyboard to transmit the message.
 - The color of displayed text, in the TX buffer screen, will be changed when transmitted.
 - To cancel the transmission, press [F12] twice.
- ④ Press [F12] of the keyboard to return to receive.

◇ Convenient functions for receive

- **Preamp** (p. 5-9)
 - ➔ Push [P.AMP] several times to set the preamp OFF, preamp 1 ON or preamp 2 ON.
 - “P.AMP1” or “P.AMP2” appears when the preamp 1 or preamp 2 is ON. Main and sub have independent preamp controls.
- **Attenuator** (p. 5-9)
 - ➔ Push [ATT] several times to set the attenuator in 6 dB steps.
 - Pushing [ATT] for 1 sec. to set the attenuator in 3 dB steps.
 - “ATT” and attenuation level appear when the attenuator is ON.
- **Noise blanker** (p. 5-17)
 - ➔ Push [NB] switch to turn the noise blanker ON and OFF, and then rotate [NB] control to adjust the threshold level.
 - Noise blanker indicator (above [NB] switch) lights when the noise blanker is ON.
 - Push [NB] for 1 sec. to enter noise blanker set mode.
- **Twin PBT (passband tuning)** (p. 5-12)
 - ➔ Rotate [TWIN PBT] controls (inner/outer).
 - Push [PBT CLEAR] to clear the settings.
- **Noise reduction** (p. 5-18)
 - ➔ Push [NR] switch to turn the noise reduction ON and OFF.
 - Rotate [NR] control to adjust the noise reduction level.
 - Noise reduction indicator (above [NR] switch) lights when the noise reduction is ON.
- **AGC (auto gain control)** (p. 5-11)
 - ➔ Push [AGC] switch several times to select AGC FAST, AGC MID or AGC SLOW.
 - Push [AGC VR] to turn the AGC time constant manual setting ON and OFF.
 - Rotate [AGC] control to adjust the time constant.
- **Fine tuning** (p. 3-7)
 - ➔ During PSK, make sure that the kHz tuning step function is OFF (no “▼” indication), push [TS] for 1 sec.
 - PSK may not be decoded correctly using the 10 Hz step tuning.
- **1/4 function** (p. 3-6)
 - ➔ Push [1/4] to turn the 1/4 function ON and OFF.

◇ About BPSK and QPSK mode

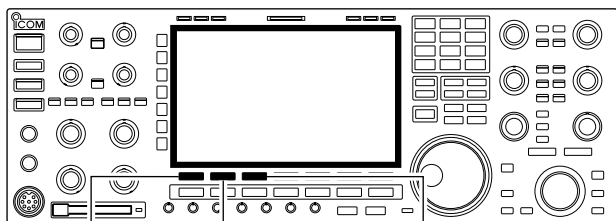

[F-1•<MENU1>] [F-2•B/QPSK] [F-3•DECODE]

• PSK decode screen— BPSK mode



• PSK decode screen— QPSK mode



BPSK and QPSK modes are available for PSK31.

- BPSK (Binary Phase Shift Keying) mode is the most commonly used mode.
- QPSK (Quadrature Phase Shift Keying) mode has error correction capability to provide better decoding than BPSK mode in marginal condition. However, more accurate tuning is required with QPSK mode, due to the tight phase margin of QPSK.

- ① During PSK mode selection, push [F-3•DECODE] to display the PSK decode screen.
- ② Push [F-1•<MENU1>] to select PSK decode menu 2.
- ③ Push [F-2•B/QPSK] to toggle between BPSK and QPSK mode alternately.

◆ Functions for the PSK decoder indication

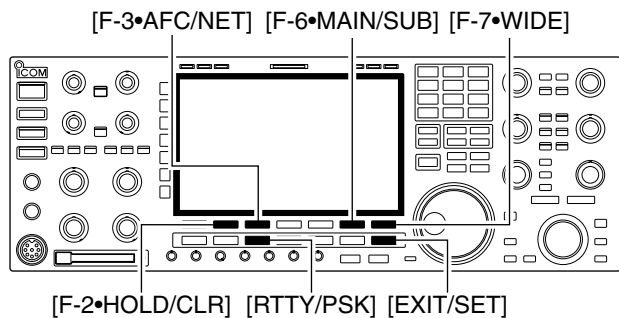

• AFC/NET indications



“AFC” and “NET” indicators Offset frequency

- ① Push a band key to select the desired band.
 - ② Push [RTTY/PSK] to select PSK.
 - After PSK mode is selected, push [RTTY/PSK] for 1 sec. to toggle between PSK and PSK-R modes.
 - “PSK” or “PSK-R” appears.
 - ③ Push [F-3•DECODE] to display the decoder screen.
 - When tuned into a PSK signal, decoded characters are displayed in the RX contents screen.
 - ④ Push [F-2•HOLD/CLR] to freeze the current screen.
 - “HOLD” appears while the function is in use.
 - Push [F-2•HOLD/CLR] again to release the function.
 - ⑤ Push [F-2•HOLD/CLR] for 1 sec. to clear the displayed characters.
 - “HOLD” indicator disappears at the same time when the hold function is in use.
 - ⑥ Push [F-3•AFC/NET] to turn the AFC function ON.
 - “AFC” appears.
 - If a PSK signal is received within the AFC tuning range, the decoder automatically tunes into the signal and the offset frequency is displayed.
 - The AFC tuning range is set to ± 15 Hz as the default. Optional ± 8 Hz setting is available in PSK decode set mode. (p. 2)
- NOTE:** The AFC function may not tune the signal properly when a weak PSK signal is received.
- ⑦ Push [F-3•AFC/NET] again to turn the NET function ON.
 - “NET” appears additionally.
 - ⑧ Push [F-3•AFC/NET] for 1 sec. to add the offset frequency to the displayed frequency.
 - ⑨ Push [F-7•WIDE] to toggle the PSK decode screen size from normal and wide.
 - S/R/F meter type during wide screen indication can be selected in display set mode. (pgs. 3-11, 12-11)
 - ⑩ Push [F-6•MAIN/SUB] to toggle the MAIN and SUB band for decode operation.
 - Dualwatch function (p. 5-16) should be ON when SUB band is selected for decode operation.
 - ⑪ Push [EXIT/SET] to close the PSK decode screen.

◆ Setting the decoder threshold level



Adjust the PSK decoder threshold level if some characters are displayed when no signal is received.

- ① Call up the PSK decoder screen as described above.
- ② Push [F-5•ADJ] to select the threshold level setting condition.
- ③ Rotate the main dial to adjust the PSK decoder threshold level.
 - Push [F-6•DEF] for 1 sec. to select the default setting.
- ④ Push [F-5•ADJ] to exit from the threshold level setting condition.

◇ PSK memory transmission

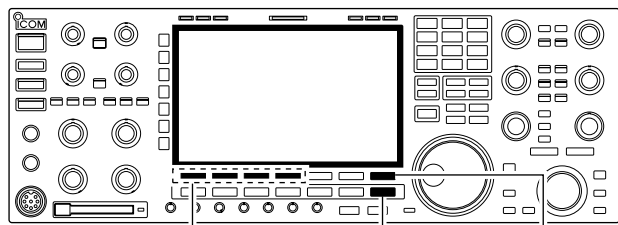

[F-1•PT1]–[F-4•PT4] [EXIT/SET] [F-7•1–4/5–8]
[F-1•PT5]–[F-4•PT8]

PSK MEMORY				
AGC MID	PT1	MYCALLx2	„DE lcom lcom K„	AUTO TX/RX
1/4 OFF	PT2	MYCALLx3	„DE lcom lcom lcom K„	AUTO TX/RX
VSC OFF	PT3	QSLUR599	„QSL UR 599 599 BK„	AUTO TX/RX
	PT4	DE+UR599	„QSL DE lcom lcom UR 599 599 BK„	AUTO TX/RX
	PT1	PT2	PT3	PT4
			EDIT	1-4/5-8

Pre-set characters can be sent using the PSK memory. Contents of the memory are set using the edit menu.

- ① During PSK mode operation, push [F-3•DECODE] to select PSK decode screen.
- ② Push [F-4•TX MEM] to select PSK memory screen.
- ③ Push [F-7•1–4/5–8] to select memory bank then push one of the function keys ([F-1•PT1] to [F-4•PT4] or [F-1•PT5] to [F-4•PT8]).
 - When no keyboard is connected, the selected memory contents will be transmitted immediately.
 - When a keyboard is connected, the memory contents will be transmitted immediately when function key is pushed, or transmitted after [F12] on the connected keyboard is pressed, depending on auto transmission/reception setting (see below).
 - The transmission date, time, reception date and/or time may be displayed in RX contents screen, depending on setting.

◇ Automatic transmission/reception setting

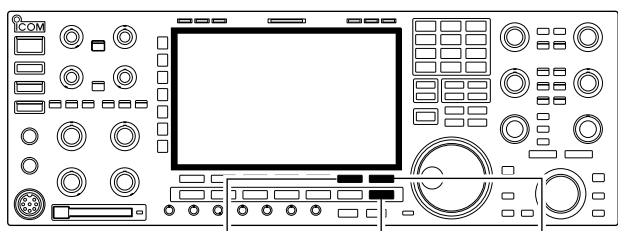

[F-6•AUTO TX] [EXIT/SET] [F-7•PT1..PT8]

PSK MEMORY EDIT				
ABC	PT1	MYCALLx2	„DE lcom lcom K„	AUTO TX/RX
ABC	PT2	MYCALLx3	„DE lcom lcom lcom K„	AUTO TX/RX
	PT3	QSLUR599	„QSL UR 599 599 BK„	AUTO TX/RX
123	PT4	DE+UR599	„QSL DE lcom lcom UR 599 599 BK„	AUTO TX/RX
		DEL	SPACE	AUTO TX
				PT1..PT8

- ① During PSK mode operation, push [F-3•DECODE] to select PSK decode screen.
- ② Push [F-4•TX MEM] to select PSK memory screen, then push [F-6•EDIT] to select PSK memory edit screen.
 - PSK memory contents of Channel 1 (PT1) is selected.
- ③ Push [F-7•PT1..PT8] several times to select the desired RTTY memory.
- ④ Push [F-6•AUTO TX] several times to select the desired condition, as follows.
 - AUTO TX/RX : Automatically transmits the selected memory and returns to receive after the transmission.
 - AUTO TX : Automatically transmits the selected memory. To return to receive, press [F12] on the keyboard.
 - AUTO RX : Press [F12] on the keyboard to transmit the selected memory. Automatically returns to receive after the transmission.
 - No indication : Press [F12] on the keyboard to transmit the selected memory and press [F12] again to return to receive.
- ⑤ Push [EXIT/SET] to return to exit from PSK memory edit condition.

NOTE: The transceiver always functions as the “AUTO TX/RX” setting when no keyboard is connected.

◇ Editing PSK memory

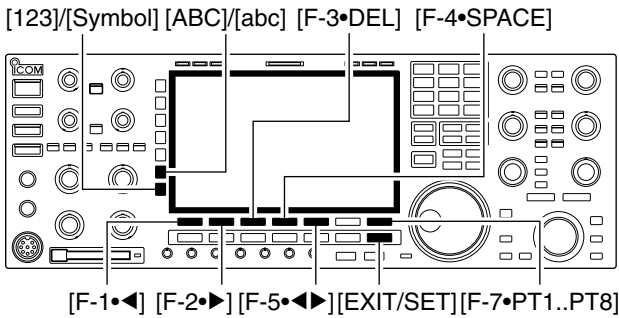

• PSK memory edit screen

ABC	PSK MEMORY EDIT		AUTO TX/RX	
PT1	MYCALLx2	↓DE lcom lcom K↓	AUTO TX/RX	
ABC	PT2	MYCALLx3	↓DE lcom lcom lcom K↓	AUTO TX/RX
PT3	QSLUR599	↓QSL UR 599 599 BK↓	AUTO TX/RX	
123	PT4	DE+UR599	↓QSL DE lcom lcom UR 599 599 BK↓	AUTO TX/RX

• Pre-programmed contents

CH	Name	Contents
PT1	MYCALLx2	↓DE lcom lcom K↓
PT2	MYCALLx3	↓DE lcom lcom lcom K↓
PT3	QSLUR599	↓QSL UR 599 599 BK↓
PT4	DE+UR599	↓QSL DE lcom lcom UR 599 599 BK↓
PT5	73 GL SK	↓73 GL SK↓
PT6	CQ CQ CQ	↓CQ CQ CQ DE lcom lcom lcom K↓
PT7	RIG&ANT	↓My transceiver is IC-7800 & Antenna is a 3-element triband yagi.↓
PT8	EQUIP.	↓My PSK equipment is internal modulator & demodulator of the IC-7800.↓

The contents of the PSK memories can be set using the memory edit menu. The memory can store 8 PSK messages for often-used PSK information. Total capacity of the memory is 70 characters per memory channel.

• Programming contents

- ① During PSK mode operation, push [F-3•DECODE] to select PSK decode screen.
- ② Push [F-4•TX MEM] to select PSK memory screen, then push [F-6•EDIT] to select PSK memory edit screen.
 - PSK memory contents of the Channel 1 (PT1) is selected.
- ③ Push [F-7•PT1..PT8] several times to select the desired PSK memory channel to be edited.
- ④ Push [F-5•◀ ▶] to select the edit item between memory contents and memory name.
 - [abc] appears when [ABC] is pushed when “ABC” character group is selected, and [Symbol] appears when [123] is pushed when “123” character group is selected.
 - Selectable characters (with the main dial);

Key selection	Editable characters
	A to Z (capital letters)
	a to z (small letters)
	0 to 9 (numbers)
	! # \$ % & ¥ ? “ ’ ` ^ + - * / . , ; = < > () [] { } _ ~ @ ↓ (“↓” is for the memory contents setting only.)

✓ For your convenience

When a PC keyboard is connected to [KEYBOARD] connector on the rear panel, the PSK memory contents can also be edited from the keyboard.

- ⑥ Push [F-1•◀] or [F-2•▶] to move the cursor backwards or forwards, respectively.
 - Pushing [F-3•DEL] deletes a character and [F-4•SPACE] inserts a space.
- ⑦ Repeat steps ⑤ and ⑥ to input the desired characters.
- ⑧ Push [EXIT/SET] to set the contents and exit PSK memory edit screen.

◇ PSK decode set mode

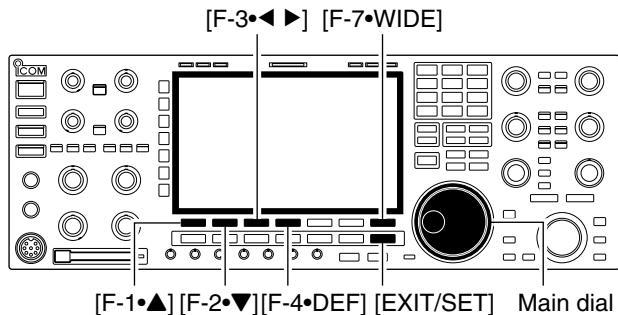

This set mode is used to set the decode USOS function, time stamp setting, etc.

• Setting contents

- ① During PSK mode operation, push [F-3•DECODE] to select PSK decode screen.
- ② Push [F-1•<MENU2>] to select PSK decode menu 2, then push [F-6•SET] to select PSK decode set mode.
 - Push [F-7•WIDE] to toggle the screen size from normal and wide.
- ③ Push [F-1•▲] or [F-2•▼] to select the desired set item.
- ④ Set the desired condition using the main dial.
 - Push [F-4•DEF] for 1 sec. to select a default condition or value.
 - Push [F-3•◀▶] to select the set contents for some items.
- ⑤ Push [EXIT/SET] to exit from set mode.

PSK FFT Scope Averaging	OFF
Set the FFT scope waveform averaging function from 2 to 4 and OFF. (default: OFF)	<p>Recommendation! If you use the FFT scope waveform for tuning, using the default or smaller number setting is recommended.</p>

PSK FFT Scope Waveform Color	
Set the color for the FFT scope waveform. <ul style="list-style-type: none"> • The color is set in RGB format. • The set color is indicated in the box beside the RGB scale. 	<ul style="list-style-type: none"> • Push [F-3•◀▶] to select R (Red), G (Green) and B (Blue), and then rotate the main dial to set the ratio from 0 to 255.

PSK AFC Range	±15Hz
Select the AFC (Automatic Frequency Control) function operating range from ±15 Hz (default) and ±8 Hz.	<p>NOTE: The AFC function may not tune the signal properly when a weak PSK signal is received.</p>

PSK Time Stamp	ON
Turn the time stamp (date, transmission or reception time) display ON and OFF.	<ul style="list-style-type: none"> • ON : Displays the time stamp. • OFF : No time stamp display.

PSK Time Stamp (Time)	Local
Selects the clock display for time stamp usage. <p>NOTE: The time won't be displayed when "OFF" is selected in "PSK Time Stamp" as above.</p>	<ul style="list-style-type: none"> • Local : Selects the time that set in "Time (Now)." • UTC* : Selects the time that set in "CLOCK2." <p>*The name of choice may differ according to "CLOCK2 Name" setting (p, 11-2). "UTC" is the default name of CLOCK2.</p>

◇ PSK decode set mode (continued)

PSK Time Stamp (Frequency)

OFF

Selects the operating frequency display for time stamp usage.

- ON : Displays the operating frequency.
- OFF : No operating frequency display.

NOTE: The frequency won't be displayed when "OFF" is selected in "PSK Time Stamp" as below left.

PSK Font Color (Receive)



Set the text color for received characters.

- The color is set in RGB format.
- The set color is indicated in the box beside the RGB scale.
- Push [F-3•◀▶] to select R (Red), G (Green) and B (Blue), and then rotate the main dial to set the ratio from 0 to 255.

PSK Font Color (Transmit)



Set the text color for transmitted characters.

- The color is set in RGB format.
- The set color is indicated in the box beside the RGB scale.
- Push [F-3•◀▶] to select R (Red), G (Green) and B (Blue), and then rotate the main dial to set the ratio from 0 to 255.

PSK Font Color (Time Stamp)



Set the text color for time stamp indication.

- The color is set in RGB format.
- The set color is indicated in the box beside the RGB scale.
- Push [F-3•◀▶] to select R (Red), G (Green) and B (Blue), and then rotate the main dial to set the ratio from 0 to 255.

PSK Font Color (TX Buffer)

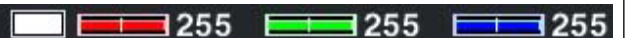

Set the text color in the TX buffer screen.

- The color is set in RGB format.
- The set color is indicated in the box beside the RGB scale.
- Push [F-3•◀▶] to select R (Red), G (Green) and B (Blue), and then rotate the main dial to set the ratio from 0 to 255.

◇ Data saving

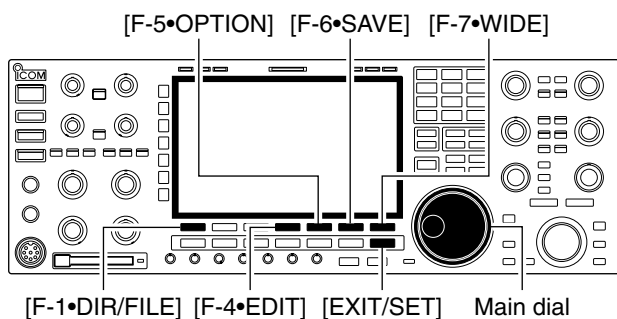

• Decode file save screen



• Decode file save screen— file name edit



• Save option screen

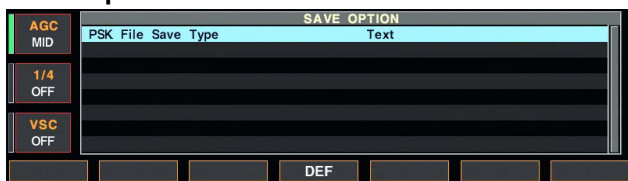

The contents of the PSK memory and received signal can be saved into the CF memory card.

- ① During PSK decode screen indication, push [F-1•<MENU1>] to select PSK decode menu 2.
- ② Push [F-5•SAVE] to select decode file save screen.
- ③ Change the following conditions if desired.

• File name:

- ① Push [F-4•EDIT] to select file name edit condition.
 - Push [F-1•DIR/FILE] several times to select the file name, if necessary.
- ② Push [ABC], [123] or [Symbol] to select the character group, then rotate the main dial to select the character.
 - [ABC] : A to Z (capital letters); [123]: 0 to 9 (numerals); [Symbol]: ! # \$ % & ' ` ^ + - = () [] { } _ ~ @ can be selected.
 - Push [F-1•◀] to move the cursor left, push [F-2•▶] to move the cursor right, [F-3•DEL] delete a character and push [F-4•SPACE] to insert a space.
- ③ Push [EXIT/SET] to set the file name.

• File format

- ① Push [F-5•OPTION] to enter save option screen.
- ② Rotate the main dial to select the saving format from Text and HTML.
 - “Text” is the default setting.
 - Push [F-4•DEF] for 1 sec. to select the default setting.
- ③ Push [EXIT/SET] to return to the previous indication.

• Saving location

- ① Push [F-1•DIR/FILE] to select tree view screen.
- ② Select the desired directory or folder in the CF memory card.
 - Push [F-4•◀▶] to select the upper directory.
 - Push [F-2•▲] or [F-3•▼] to select folder in the same directory.
 - Push [F-4•◀▶] for 1 sec. to select a folder in the directory.
 - Push [F-5•REN/DEL] to rename the folder.
 - Push [F-5•REN/DEL] for 1 sec. to delete the folder.
 - Push [F-6•MAKE] for 1 sec. to make a new folder. (Edit the name with the same manner as the “• File name” above.)
- ③ Push [F-1•DIR/FILE] twice to select the file name.
- ④ Push [F-6•SAVE].
 - After the saving is completed, return to PSK decode menu 2 automatically.

✓ For your convenience!

Two data formats, Text and HTML, are available for PC data storage.

■ Operating AM

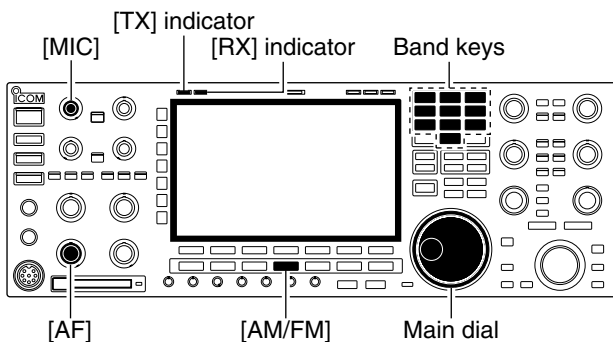

- ① Push a band key to select the desired band.
- ② Push [AM/FM] to select AM.
 - “AM” indicator appears.
 - After AM mode is selected, push [AM/FM] to toggle between AM and FM modes.
- ③ Rotate the main dial to tune the desired frequency.
 - The S-meter indicates received signal strength when signal is received.
- ④ Rotate [AF] to set audio to a comfortable listening level.
- ⑤ Push [TRANSMIT] or [PTT] (microphone) to transmit.
 - The TX indicator lights red.
- ⑥ Speak into the microphone at your normal voice level.
 - Adjust the microphone gain with [MIC] at this step, if necessary.
- ⑦ Push [TRANSMIT] or release [PTT] (microphone) to return to receive.

◇ Convenient functions for receive

- **Preamp** (p. 5-9)
 - ➔ Push [P.AMP] several times to set the preamp OFF, preamp 1 ON or preamp 2 ON.
 - “P.AMP1” or “P.AMP2” appears when the preamp 1 or preamp 2 is ON. Main and sub have independent preamp controls.
 - **Attenuator** (p. 5-9)
 - ➔ Push [ATT] several times to set the attenuator in 6 dB steps.
 - Pushing [ATT] for 1 sec. to set the attenuator in 3 dB steps.
 - “ATT” and attenuation level appear when the attenuator is ON.
 - **Noise blanker** (p. 5-17)
 - ➔ Push [NB] switch to turn the noise blanker ON and OFF, and then rotate [NB] control to adjust the threshold level.
 - Noise blanker indicator (above [NB] switch) lights when the noise blanker is ON.
 - Push [NB] for 1 sec. to enter noise blanker set mode.
 - **Noise reduction** (p. 5-18)
 - ➔ Push [NR] switch to turn the noise reduction ON and OFF.
 - Rotate [NR] control to adjust the noise reduction level.
 - Noise reduction indicator (above [NR] switch) lights when the noise reduction is ON.
 - **Twin PBT (passband tuning)** (p. 5-12)
 - ➔ Rotate [TWIN PBT] controls (inner/outer).
 - Push [PBT CLEAR] to clear the settings.
 - **Notch filter** (p. 5-19)
 - ➔ Push [NOTCH] switch to turn the manual notch function ON and OFF.
 - Rotate [NOTCH] control to set the attenuating frequency.
 - Notch indicator (above [NOTCH] switch) lights when either the manual notch is ON.
 - **AGC (auto gain control)** (p. 5-11)
 - ➔ Push [AGC] switch several times to select AGC FAST, AGC MID or AGC SLOW.
 - Rotate [AGC] control to adjust the time constant.
 - **Auto tuning function** (p. 1-9)
 - ➔ Push [AUTO TUNE] to turn the auto tuning function ON and OFF.
 - The transceiver automatically tunes the desired signal within ± 5 kHz range.
- IMPORTANT!**
When receiving a weak signal, or receiving a signal with interference, the automatic tuning function may not tune, or may tune to an undesired signal.

◇ Convenient functions for transmit

- | | |
|---|---|
| <ul style="list-style-type: none">• VOX (voice operated transmit) (p. 6-2)<ul style="list-style-type: none">➔ Push [VOX/BK-IN] to turn the VOX function ON and OFF.<ul style="list-style-type: none">• “VOX” appears when the VOX function is ON.• Transmit quality monitor (p. 6-4)<ul style="list-style-type: none">➔ Push [MONI] to turn the monitor function ON and OFF.<ul style="list-style-type: none">• Rotate [MONI GAIN] to adjust the monitor gain.• Monitor indicator (above [MONI] switch) lights when the monitor function is ON. | <ul style="list-style-type: none">• Audio tone control (p. 12-4)<ul style="list-style-type: none">➔ Push [F-7•SET] then [F-1•LEVEL] to enter level set mode. Select an item with [F-1•▲]/[F-2•▼] then rotate the main dial to adjust the audio tone. |
|---|---|

■ Operating FM

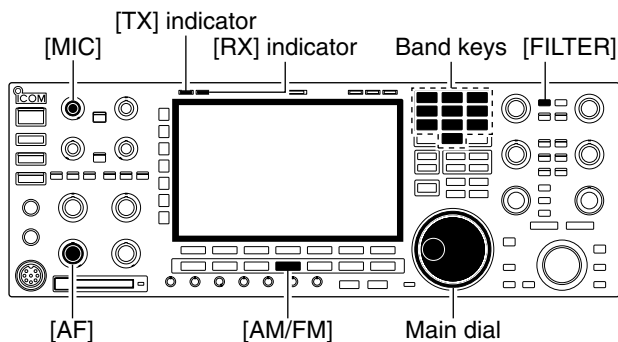

- ① Push a band key to select the desired band.
- ② Push [AM/FM] to select FM.
 - “FM” indicator appears.
 - After FM mode is selected, push [AM/FM] to toggle between FM and AM modes.
- ③ Rotate the main dial to tune the desired frequency.
 - The S-meter indicates received signal strength when signal is received.
 - 10 kHz tuning step is preset for the FM mode.
 - Push [FILTER] several times to select the desired filter width.
- ④ Rotate [AF] to set audio to a comfortable listening level.
- ⑤ Push [TRANSMIT] or [PTT] (microphone) to transmit.
 - The TX indicator lights red.
- ⑥ Speak into the microphone at your normal voice level.
 - Adjust the microphone gain with [MIC] at this step, if necessary.
 - FM narrow transmission is available when “FIL2” or “FIL3” is selected.
- ⑦ Push [TRANSMIT] or release [PTT] (microphone) to return to receive.

◇ Convenient functions for receive

- **Preamp** (p. 5-9)
 - ➔ Push [P.AMP] several times to set the preamp OFF, preamp 1 ON or preamp 2 ON.
 - “P.AMP1” or “P.AMP2” appears when the preamp 1 or preamp 2 is ON. Main and sub have independent preamp controls.
- **Auto notch filter** (p. 5-19)
 - ➔ Push [NOTCH] switch to turn the auto notch function ON and OFF.
 - Notch indicator (above [NOTCH] switch) lights when either the manual notch is ON.
- **Attenuator** (p. 5-9)
 - ➔ Push [ATT] several times to set the attenuator in 6 dB steps.
 - Pushing [ATT] for 1 sec. to set the attenuator in 3 dB steps.
 - “ATT” and attenuation level appear when the attenuator is ON.

◇ Convenient functions for transmit

- **VOX (voice operated transmit)** (p. 6-2)
 - ➔ Push [VOX/BK-IN] to turn the VOX function ON and OFF.
 - “VOX” appears when the VOX function is ON.
- **Transmit quality monitor** (p. 6-4)
 - ➔ Push [MONI] to turn the monitor function ON and OFF.
 - Rotate [MONI GAIN] to adjust the monitor gain.
 - Monitor indicator (above [MONI] switch) lights when the monitor function is ON.
- **Audio tone control** (p. 12-4)
 - ➔ Push [F-7•SET] then [F-1•LEVEL] to enter level set mode. Select an item with [F-1•▲]/[F-2•▼] then rotate the main dial to adjust the audio tone.

■ Repeater operation

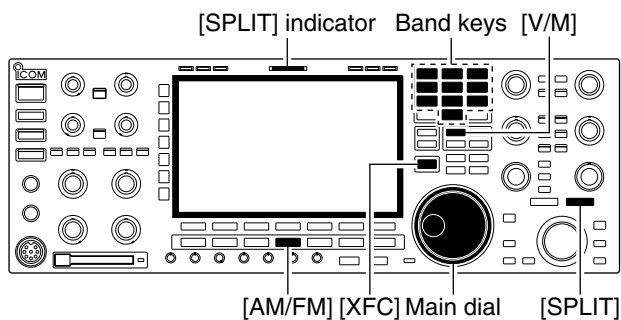

A repeater amplifies received signals and retransmits them at a different frequency. When using a repeater, the transmit frequency is shifted from the receive frequency by an offset frequency. A repeater can be accessed using split frequency operation with the shift frequency set to the repeater's offset frequency.

For accessing a repeater which requires a repeater tone, set the repeater tone frequency in tone frequency set mode as described below.

- ① Set the offset frequencies (HF, 50 MHz) and turn ON the quick split function in miscellaneous (others) set mode in advance. (p. 12-15)
- ② Push [V/M] to select VFO mode.
- ③ Push the desired band key.
- ④ Push [AM/FM] several times to select FM mode.
- ⑤ Set the receive frequency (repeater output frequency).
- ⑥ Push [SPLIT] for 1 sec. to start repeater operation.
 - Repeater tone is turned ON automatically.
 - [SPLIT] indicator lights and "SPLIT" appears on the LCD.
 - Shifted transmit frequency and "TX" appear in the sub band.
 - The transmit frequency can be monitored while pushing [XFC] or using dualwatch.
- ⑦ Push and hold [PTT] to transmit; release [PTT] to receive.
- ⑧ To return to simplex, push [SPLIT] momentarily.

◇ Repeater tone frequency setting

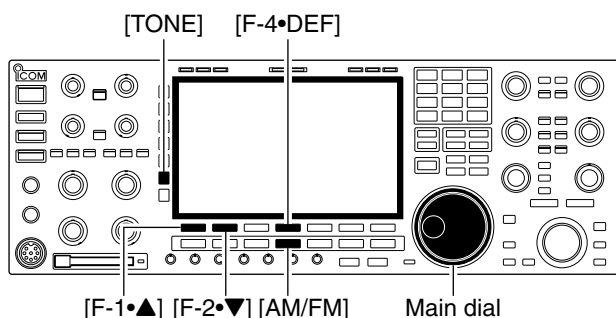

Some repeaters require subaudible tones to be accessed. Subaudible tones are superimposed over your normal signal and must be set in advance. The transceiver has 50 tones from 67.0 Hz to 254.1 Hz.

- ① Select FM mode.
- ② Push [TONE] for 1 sec. to tone frequency set mode.
- ③ Push [F-1•▲] or [F-2•▼] to select REPEATER TONE item.
- ④ Rotate the main dial to select the desired repeater tone frequency.
 - Push [F-4•DEF] for 1 sec. to select the default setting.
- ⑤ Push [EXIT/SET] to return to the previous indication.

• Available tone frequencies (unit: Hz)

67.0	85.4	107.2	136.5	165.5	186.2	210.7	254.1
69.3	88.5	110.9	141.3	167.9	189.9	218.1	
71.9	91.5	114.8	146.2	171.3	192.8	225.7	
74.4	94.8	118.8	151.4	173.8	196.6	229.1	
77.0	97.4	123.0	156.7	177.3	199.5	233.6	
79.7	100.0	127.3	159.8	179.9	203.5	241.8	
82.5	103.5	131.8	162.2	183.5	206.5	250.3	

■ Tone squelch operation

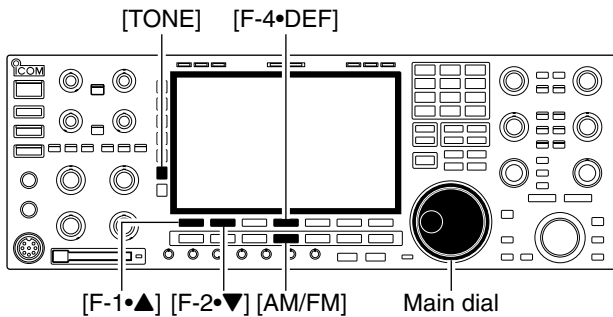

The tone squelch opens only when receiving a signal containing a matching subaudible tone. You can silently wait for calls from group members using the same tone.

- ① Set the desired frequency band and select FM mode.
- ② Push [TONE] to turn the tone squelch function ON.
 - “TSQL” appears
- ③ Push [TONE] for 1 sec. to tone frequency set mode.
- ④ Push [F-1•▲] or [F-2•▼] to select T-SQL TONE item.
- ⑤ Rotate the main dial to select the desired tone squelch frequency.
 - Push [F-4•DEF] for 1 sec. to select the default setting.
- ⑥ Push [EXIT/SET] to return to the previous indication.
- ⑦ When the received signal includes a matching tone, squelch opens and the signal can be heard.
 - When the received signal's tone does not match, tone squelch does not open, however, the S-indicator shows signal strength.
 - To open the squelch manually, push [XFC].
- ⑧ Operate the transceiver in the normal way.
- ⑨ To cancel the tone squelch, push [TONE] to clear “TSQL.”

• Available tone frequencies

(unit: Hz)

67.0	85.4	107.2	136.5	165.5	186.2	210.7	254.1
69.3	88.5	110.9	141.3	167.9	189.9	218.1	
71.9	91.5	114.8	146.2	171.3	192.8	225.7	
74.4	94.8	118.8	151.4	173.8	196.6	229.1	
77.0	97.4	123.0	156.7	177.3	199.5	233.6	
79.7	100.0	127.3	159.8	179.9	203.5	241.8	
82.5	103.5	131.8	162.2	183.5	206.5	250.3	

■ Data mode (AFSK) operation

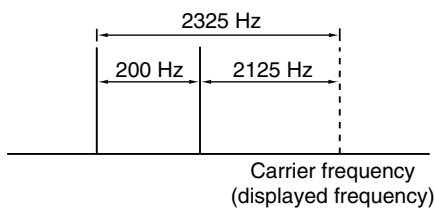
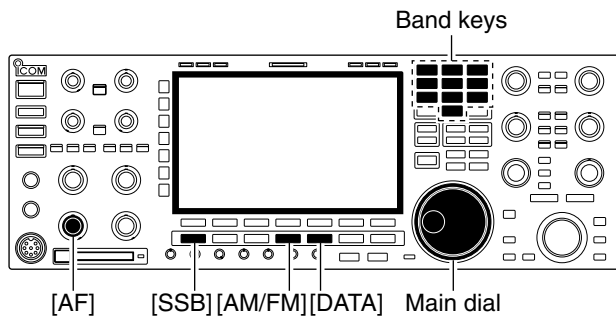

When operating AMTOR or PACKET with your TNC and/or PC software, consult the manual that comes with the TNC and/or the software.

- ① Connect a PC and TNC to the transceiver. (p. 2-8)
- ② Push a band key to select the desired band.
- ③ Push [SSB] or [AM/FM] to select the desired operating mode.
- ④ Push [DATA] to turn data mode ON.
 - One of “-D1,” “-D2” or “-D3” is additionally appears.
 - During data mode selection, pushing [DATA] for 1 sec. to select data mode 1 (D1), 2 (D2) and 3 (D3) in sequence.
- ⑤ Rotate the main dial to tune into the desired signal and decoded correctly.
 - Also use the tuning indicator of the TNC or software.
 - During SSB data mode, 1/4 tuning function can be used for critical tuning.
- ⑥ Operate the PC (software) or TNC to transmit.
 - When operating in SSB data mode, adjust the TNC output level so that the ALC meter reading doesn't go outside the ALC zone.

NOTE: When SSB data mode is selected, the audio input from the [ACC1] (pin 6) is used for transmission instead of [MIC]'s.
The fixed condition is used for SSB data transmission as follows:

- [COMP] : OFF
- Tx bandwidth : MID
- Tx Tone (Bass) : 0
- Tx Tone (Trebles): 0

✓ For your information

Carrier frequency is displayed when SSB data mode is selected.

See the diagram left for the tone-pair example.

■ Spectrum scope screen	5-2
◇ Center mode	5-2
◇ Fix mode	5-3
◇ Mini scope screen indication	5-4
◇ Scope set mode	5-4
■ Preamplifier	5-9
■ Attenuator	5-9
■ RIT function	5-10
◇ RIT monitor function	5-10
■ AGC function	5-11
◇ Selecting the preset value	5-11
◇ Adjusting the AGC time constant	5-11
◇ Setting the AGC time constant preset value	5-11
■ Twin PBT operation	5-12
■ IF filter selection	5-13
◇ IF filter selection	5-13
◇ Filter passband width setting (except FM mode)	5-13
◇ Roofing filter selection	5-14
◇ DSP filter shape	5-14
◇ Filter shape set mode	5-14
■ Dualwatch operation	5-16
■ Noise blanker	5-17
◇ NB set mode	5-17
■ Noise reduction	5-18
■ Dial lock function	5-18
■ Notch function	5-19
■ Digital selector	5-19

■ Spectrum scope screen

◇ Center mode

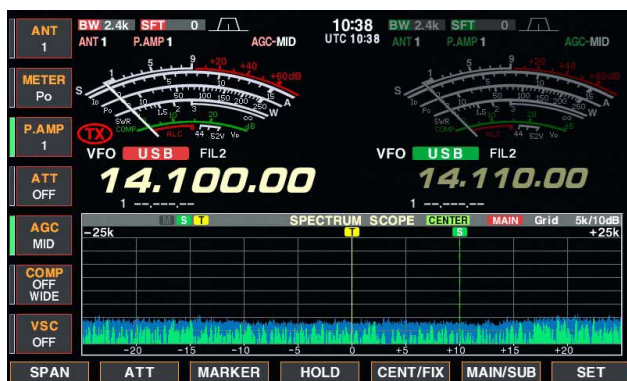
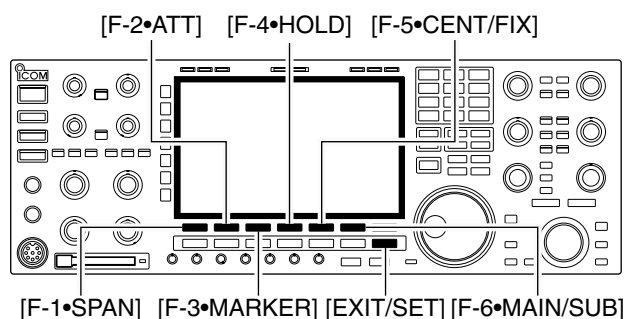

• Observed indication example

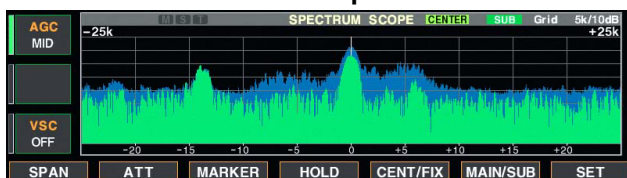

This DSP-based spectrum scope allows you to display the conditions on the selected band, as well as relative strengths of signals. The IC-7800 has two modes for the spectrum indication— one is center mode, and another one is fix mode.

In addition, the IC-7800 has a mini scope screen to save screen space.

Displays signals around the set frequency within the selected span. The set frequency is always displayed at the center of the screen.

- ① Push [EXIT/SET] several times to close a multi-function screen, if necessary.
- ② Push [F-1•SCOPE] to select the scope screen.
- ③ Push [F-5•CENT/FIX] to select the center mode.
 - “CENTER” is displayed when center mode is selected.
- ④ Push [F-1•SPAN] several times to select the scope span.
 - ±2.5, ±5.0, ±10, ±25, ±50, ±100 and ±250 kHz are available.
 - Sweeping speed is selectable for each span independently in scope set mode. (pgs. 5-5, 5-6)
- ⑤ Push [F-2•ATT] several times to activate an attenuator or turn the attenuator OFF.
 - 10, 20 and 30 dB attenuators are available.
- ⑥ Push [F-6•MAIN/SUB] to select main band.
 - The spectrum scope with sub band selection is activated during dualwatch or split frequency operation only.
- ⑦ Push [F-3•MARKER] several times to select the marker (sub readout or transmit frequency) or turn the marker OFF.
 - “T” displays the marker at the transmit frequency.
 - “S” displays the marker at the sub readout frequency.
 - “<<” or “>>” appears when the marker is out of range.
 - The spectrum scope shows the transmit signal waveform while transmitting. This can be deactivated in scope set mode. (p. 5-4)
 - The spectrum scope shows the peak level holding function. Peak levels are displayed in the background of the current spectrum in a different color until the receive frequency changes. This can be deactivated and the waveform color can be set in scope set mode. (p. 5-5)
- ⑧ Push [F-4•HOLD] to freeze the current spectrum waveform.
 - “HOLD” appears while the function is in use.
 - The peak hold function can be deactivated in scope set mode.
- ⑨ Push [EXIT/SET] to exit the scope screen.

NOTE: If a strong signal is received, a ghost waveform may appear. Push [F-2•ATT] several times to activate the spectrum scope attenuator in this case. Spurious signal waveforms may be displayed. They are generated in the internal scope circuit and do not indicate a transceiver malfunction.

◇ Fix mode

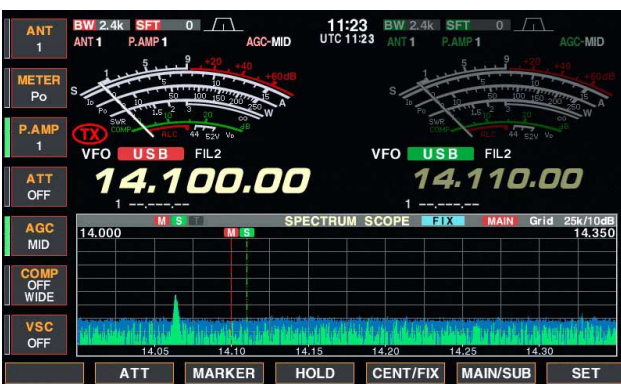
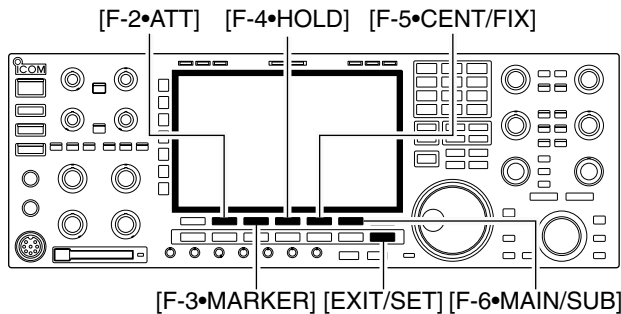

Displays signals within the specified frequency range. The selected frequency band conditions can be observed at a glance when using this mode.

- ① Push [EXIT/SET] several times to close a multi-function screen, if necessary.
- ② Push [F-1•SCOPE] to select the scope screen.
- ③ Push [F-5•CENT/FIX] to select the fix mode.
 - “**FIX**” is displayed when fix mode is selected.
- ④ Push [F-2•ATT] several times to activate an attenuator or turn the attenuator OFF.
 - 10, 20 and 30 dB attenuators are available.
- ⑤ Push [F-6•MAIN/SUB] to select main band.
 - The spectrum scope with sub band selection is activated during dualwatch or split frequency operation only.
- ⑥ Push [F-3•MARKER] several times to select the marker (sub readout or transmit frequency) or turn the marker OFF.
 - “**M**” displays the marker at the main readout frequency. (always displayed)
 - “**T**” displays the marker at the transmit frequency.
 - “**S**” displays the marker at the sub readout frequency.
 - “<<” or “>>” appears when the marker is out of range.
 - The spectrum scope shows the transmit signal waveform while transmitting. This can be deactivated in scope set mode. (p. 5-4)
 - The spectrum scope shows the peak level holding function. Peak levels are displayed in the background of the current spectrum in a different color until the receive frequency changes. This can be deactivated and the waveform color can be set in scope set mode. (p. 5-5)
- ⑦ Push [F-4•HOLD] to freeze the current spectrum waveform.
 - “**HOLD**” appears while the function is in use.
 - The peak hold function can be deactivated in scope set mode.
- ⑧ Push [EXIT/SET] to exit the scope screen.

/// **NOTE:** If a strong signal is received, a ghost waveform may appear. Push [F-2•ATT] several times to activate the spectrum scope attenuator in this case.

/// The scope bandwidth can be specified for each operating frequency band independently in scope set mode. (pgs. 5-6 to 5-8)

5 FUNCTIONS FOR RECEIVE

◇ Mini scope screen indication

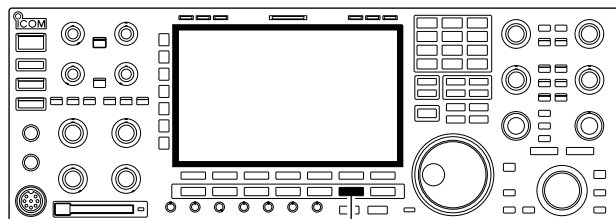

[M.SCOPE]

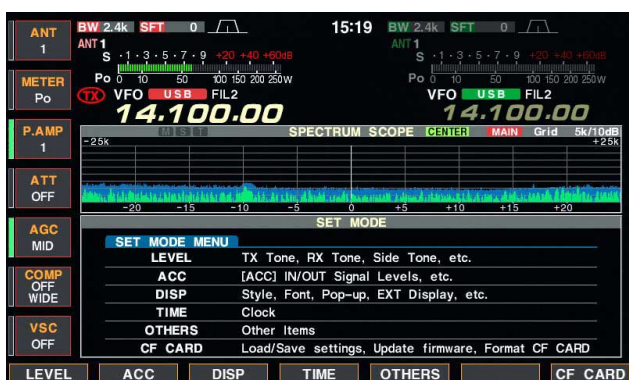

The mini scope screen can be displayed with another screen display, such as set mode menu, decoder screen, memory list screen, etc. simultaneously.

- ① Set the scope mode (center or fix), marker, attenuator, span, etc. in advance. (pgs. 5-2, 5-3)
- ② Push [M.SCOPE] to toggle the mini scope indication ON and OFF.
 - The S/R/F meter type during mini scope indication can be selected in display set mode (Meter Type (Wide Screen) item). (p. 12-11)

◇ Scope set mode

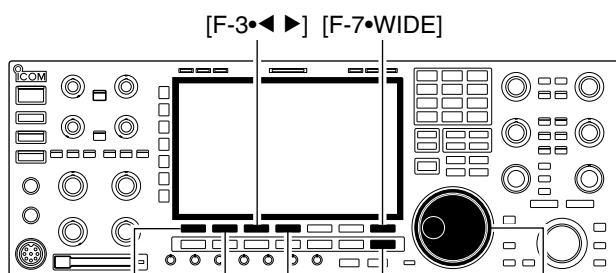

[F-1•▲] [F-2•▼] [F-4•DEF] [EXIT/SET] Main dial



This set mode is used to set the waveform color, sweeping speed, scope range for fix mode, etc.

- ① During spectrum scope display ON, push [F-7•SET] to select scope set mode screen.
 - Push [F-7•WIDE] to toggle the screen size between normal and wide.
- ② Push [F-1•▲] or [F-2•▼] to select the desired set item.
- ③ Set the desired condition using the main dial.
 - Push [F-4•DEF] for 1 sec. to select the default condition or value.
 - Push [F-3•◀ ▶] to select the set contents for some items.
- ④ Push [EXIT/SET] to exit from set mode.

Scope during Tx (CENTER Type)

ON

Turn the transmitting signal waveform indication ON and OFF.

NOTE: The transmitting signal waveform indication is available for the center mode only.

◇ Scope set mode (continued)

Max Hold	ON
Turn the peak level holding function ON and OFF.	

CENTER Type Display	Filter Center
Select the center frequency of the spectrum scope indication (center mode only).	<ul style="list-style-type: none"> • Filter center : Shows the selected filter's center frequency at the center. • Carrier Point Center : Shows the selected operating mode carrier point frequency at the center. • Carrier Point Center (Abs. Freq.) : In addition to the carrier point center setting above, the actual frequency is displayed for the bottom of the scope.

Waveform Color (Current)	
Set the waveform color for the currently received signals.	<ul style="list-style-type: none"> • The color is set in RGB format. • Push [F-3•◀ ▶] to select R (Red), G (Green) and B (Blue), and rotate the ratio from 0 to 255 range. • The set color is indicated in the box beside the RGB scale.

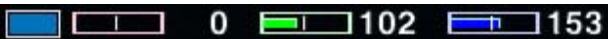
Waveform Color (Max Hold)	
Set the waveform color for the receiving signals maximum level.	<ul style="list-style-type: none"> • The color is set in RGB format. • Push [F-3•◀ ▶] to select R (Red), G (Green) and B (Blue), and rotate the ratio from 0 to 255 range. • The set color is indicated in the box beside the RGB scale.

Sweep Speed (± 2.5k)	MID
Select the sweeping speed for the ±2.5 kHz span selection from SLOW, MID and FAST.	 NOTE: The waveform may be displayed incorrectly with "FAST" setting.

(± 5k)	MID
Select the sweeping speed for the ±5 kHz span selection from SLOW, MID and FAST.	 NOTE: The waveform may be displayed incorrectly with "FAST" setting.

(± 10k)	FAST
Select the sweeping speed for the ±10 kHz span selection from SLOW, MID and FAST.	

(± 25k)	FAST
Select the sweeping speed for the ±25 kHz span selection from SLOW, MID and FAST.	

◇ Scope set mode (continued)

(± 50k)	FAST
Select the sweeping speed for the ±50 kHz span selection from SLOW, MID and FAST.	

(±100k)	FAST
Select the sweeping speed for the ±100 kHz span selection from SLOW, MID and FAST.	

(±250k)	FAST
Select the sweeping speed for the ±250 kHz span selection from SLOW, MID and FAST.	

Fixed Edges (0.03 – 1.60)	0.750 – 1.250 MHz
Set the scope edge frequencies for fix mode scope with below 1.6 MHz band selection.	<ul style="list-style-type: none"> • Set the frequencies within 0.030 to 1.600 MHz range in 1 kHz steps. ▨ Up to 500 kHz band width can be specified, so either edge frequency will be set to the difference between higher and lower frequencies become 5 to 500 kHz automatically while setting another edge frequency.

(1.60 – 2.00)	1.800 – 2.000 MHz
Set the scope edge frequencies for fix mode scope when 1.6 to 2 MHz band is selected.	<ul style="list-style-type: none"> • Set the frequencies within 1.600 to 2.000 MHz range in 1 kHz steps.

(2.00 – 6.00)	3.500 – 4.000 MHz
Set the scope edge frequencies for fix mode scope when 2 to 6 MHz band is selected.	<ul style="list-style-type: none"> • Set the frequencies within 2.000 to 6.000 MHz range in 1 kHz steps. ▨ Up to 500 kHz band width can be specified, so either edge frequency will be set to the difference between higher and lower frequencies become 5 to 500 kHz automatically while setting another edge frequency.

(6.00 – 8.00)	7.000 – 7.300 MHz
Set the scope edge frequencies for fix mode scope when 6 to 8 MHz band is selected.	<ul style="list-style-type: none"> • Set the frequencies within 6.000 to 8.000 MHz range in 1 kHz steps. ▨ Up to 500 kHz band width can be specified, so either edge frequency will be set to the difference between higher and lower frequencies become 5 to 500 kHz automatically while setting another edge frequency.

◇ Scope set mode (continued)

(8.00 – 11.00)	10.100 – 10.150 MHz
Set the scope edge frequencies for fix mode scope when 8 to 11 MHz band is selected.	<ul style="list-style-type: none"> • Set the frequencies within 8.000 to 11.000 MHz range in 1 kHz steps. ▨ Up to 500 kHz band width can be specified, so either edge frequency will be set to the difference between higher and lower frequencies become 5 to 500 kHz automatically while setting another edge frequency.
(11.00 – 15.00)	14.000 – 14.350 MHz
Set the scope edge frequencies for fix mode scope when 11 to 15 MHz band is selected.	<ul style="list-style-type: none"> • Set the frequencies within 11.000 to 15.000 MHz range in 1 kHz steps. ▨ Up to 500 kHz band width can be specified, so either edge frequency will be set to the difference between higher and lower frequencies become 5 to 500 kHz automatically while setting another edge frequency.
(15.00 – 20.00)	18.068 – 18.168 MHz
Set the scope edge frequencies for fix mode scope when 15 to 20 MHz band is selected.	<ul style="list-style-type: none"> • Set the frequencies within 15.000 to 20.000 MHz range in 1 kHz steps. ▨ Up to 500 kHz band width can be specified, so either edge frequency will be set to the difference between higher and lower frequencies become 5 to 500 kHz automatically while setting another edge frequency.
(20.00 – 22.00)	21.000 – 21.450 MHz
Set the scope edge frequencies for fix mode scope when 20 to 22 MHz band is selected.	<ul style="list-style-type: none"> • Set the frequencies within 20.000 to 22.000 MHz range in 1 kHz steps. ▨ Up to 500 kHz band width can be specified, so either edge frequency will be set to the difference between higher and lower frequencies become 5 to 500 kHz automatically while setting another edge frequency.
(22.00 – 26.00)	24.890 – 24.990 MHz
Set the scope edge frequencies for fix mode scope when 22 to 26 MHz band is selected.	<ul style="list-style-type: none"> • Set the frequencies within 22.000 to 26.000 MHz range in 1 kHz steps. ▨ Up to 500 kHz band width can be specified, so either edge frequency will be set to the difference between higher and lower frequencies become 5 to 500 kHz automatically while setting another edge frequency.

◇ Scope set mode (continued)

(26.00 – 30.00)	28.000 – 28.500 MHz
Set the scope edge frequencies for fix mode scope when 26 to 30 MHz band is selected.	<ul style="list-style-type: none">• Set the frequencies within 26.000 to 30.000 MHz range in 1 kHz steps.<ul style="list-style-type: none">/// Up to 500 kHz band width can be specified, so either edge frequency will be set to the difference between higher and lower frequencies become 5 to 500 kHz automatically while setting another edge frequency.

(30.00 – 45.00)	30.000 – 30.500 MHz
Set the scope edge frequencies for fix mode scope when 30 to 45 MHz band is selected.	<ul style="list-style-type: none">• Set the frequencies within 30.000 to 45.000 MHz range in 1 kHz steps.<ul style="list-style-type: none">/// Up to 500 kHz band width can be specified, so either edge frequency will be set to the difference between higher and lower frequencies become 5 to 500 kHz automatically while setting another edge frequency.

(45.00 – 60.00)	50.000 – 50.500 MHz
Set the scope edge frequencies for fix mode scope when 45 to 60 MHz band is selected.	<ul style="list-style-type: none">• Set the frequencies within 45.000 to 60.000 MHz range in 1 kHz steps.<ul style="list-style-type: none">/// Up to 500 kHz band width can be specified, so either edge frequency will be set to the difference between higher and lower frequencies become 5 to 500 kHz automatically while setting another edge frequency.

■ Preamplifier

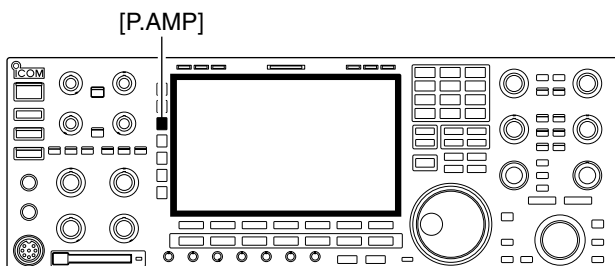

The preamp amplifies received signals in the receiver front end, to improve the S/N ratio and sensitivity. Set this to preamp 1 or preamp 2 when receiving weak signals.

➔ Push [P.AMP] several times to set the preamp OFF, preamp 1 ON or preamp 2 ON.



For all HF bands



High-gain preamp for 24 MHz band and above

✓ About the "P.AMP2"

The "P.AMP 2" is a high gain receive amplifier. When the "P.AMP 2" is used during times of strong electric fields, distortion sometimes results. In such cases, use the transceiver with the "P.AMP 1" or "P.AMP OFF" setting.

The "P.AMP 2" is most effective when:

- Used on bands above 24 MHz and when electric fields are weak.
- Receive sensitivity is insufficient during low gain, or while using a narrow band antenna (such as small loop, a Beverage antenna or a short Yagi antenna).

■ Attenuator

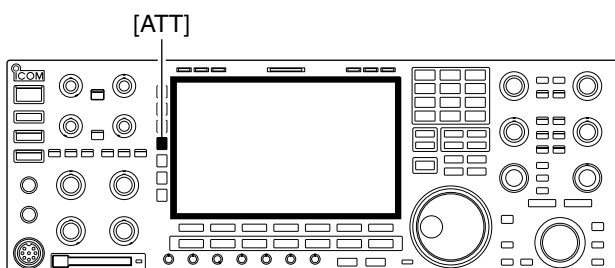

The attenuator prevents a desired signal from distortion when very strong signals are near the desired frequency or when very strong electric fields, such as from broadcasting stations, are near your location.

➔ Push [ATT] several times to set the attenuator 6 dB, 12 dB, 18 dB or attenuator OFF.

➔ Push [ATT] for 1 sec. several times to set the attenuator 3 dB, 6 dB, 9 dB, 12 dB, 15 dB, 18 dB, 21 dB or attenuator OFF.



3 dB attenuation



15 dB attenuation



6 dB attenuation



18 dB attenuation



9 dB attenuation



21 dB attenuation



12 dB attenuation

■ RIT function

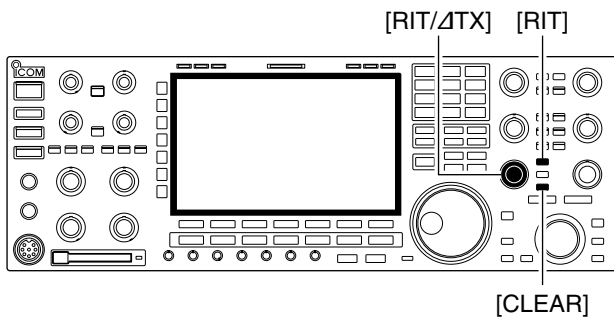

The RIT (Receive Increment Tuning) function compensates for off-frequencies of the communicating station.

The function shifts the receive frequency up to ± 9.99 kHz in 10 Hz steps without moving the transmit frequency.

- ① Push [RIT] to turn the RIT function ON and OFF.
 - “RIT” and the shifting frequency appear when the function is ON.
- ② Rotate the [RIT/ΔTX] control.
 - Push [CLEAR] for 1 sec. to reset the RIT frequency.
 - Push [CLEAR] momentarily to reset the RIT frequency when the quick RIT/ΔTX clear function is ON. (p. 12-18)
 - Push [RIT] for 1 sec. to add the shift frequency to the operating frequency.

◇ RIT monitor function

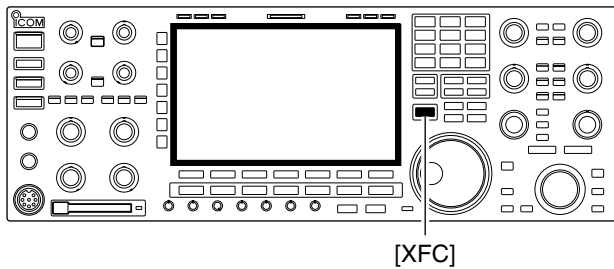

When the RIT function is ON, pushing and holding [XFC] allows you to monitor the operating frequency directly (RIT is temporarily cancelled).

✓ For your convenience— Calculate function

The shift frequency of the RIT function can be added/subtracted to the displayed frequency.

- ➡ While displaying the RIT shift frequency, push [RIT] for 1 sec.
-

■ AGC function

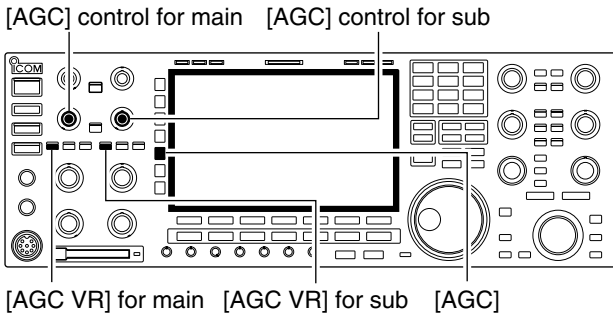

The AGC (auto gain control) controls receiver gain to produce a constant audio output level even when the received signal strength varies greatly.

The transceiver has 3 preset AGC characteristics (time constant: fast, mid, slow) for non-FM mode.

▨ The FM mode AGC time constant is fixed as 'FAST' (0.1 sec.) and AGC time constant cannot be selected.

◇ Selecting the preset value

- ① Select non-FM mode.
- ② Push [AGC] several times to select AGC fast, AGC medium (MID) or AGC slow.
 - Push [AGC VR] for 1 sec. to turn the AGC function OFF.

◇ Adjusting the AGC time constant

- ① Select non-FM mode.
- ② Push [AGC VR], then rotate [AGC] control to adjust the AGC time constant.
 - [AGC VR] indicator above the switch lights green.

◇ Setting the AGC time constant preset value



- ① Select the desired mode (not FM mode).
- ② Push [AGC] for 1 sec. to enter AGC set mode.
- ③ Push [AGC] several times to select FAST time constant.
- ④ Rotate the main dial to set the desired time constant for 'AGC FAST.'
 - AGC time constant can be set between 0.1 to 8.0 sec. (depends on mode) or turned OFF.
 - Push [F-4•DEF] for 1 sec. to select a default value.
- ⑤ Push [AGC] to select medium time constant.
- ⑥ Rotate the main dial to set the desired time constant for 'AGC MID.'
 - AGC time constant can be set between 0.1 to 8.0 sec. (depends on mode) or turned OFF.
 - Push [F-4•DEF] for 1 sec. to select a default value.
- ⑦ Push [AGC] to select slow time constant.
- ⑧ Rotate the main dial to set the desired time constant for 'AGC SLOW.'
 - AGC time constant can be set between 0.1 to 8.0 sec. (depends on mode) or turned OFF.
 - Push [F-4•DEF] for 1 sec. to select a default value.
- ⑨ Select another mode (not FM). Repeat steps ③ to ⑧ if desired.
- ⑩ Push [EXIT/SET] to exit the AGC set mode screen.

• Selectable AGC time constant (unit: sec.)

Mode	Default	Selectable AGC time constant
SSB	0.3 (FAST)	0.1, 0.2, 0.3, 0.5, 0.8, 1.2, 1.6, 2.0, 2.5, 3.0, 4.0, 5.0, 6.0
	2.0 (MID)	
	6.0 (SLOW)	
CW	0.1 (FAST)	0.1, 0.2, 0.3, 0.5, 0.8, 1.2, 1.6, 2.0, 2.5, 3.0, 4.0, 5.0, 6.0
	0.5 (MID)	
	1.2 (SLOW)	
RTTY PSK	0.1 (FAST)	0.1, 0.2, 0.3, 0.5, 0.8, 1.2, 1.6, 2.0, 2.5, 3.0, 4.0, 5.0, 6.0
	0.5 (MID)	
	1.2 (SLOW)	
AM	3.0 (FAST)	0.3, 0.5, 0.8, 1.2, 1.6, 2.0, 2.5, 3.0, 4.0, 5.0, 6.0, 7.0, 8.0
	5.0 (MID)	
	7.0 (SLOW)	
FM	0.1 (FAST)	Fixed

■ Twin PBT operation

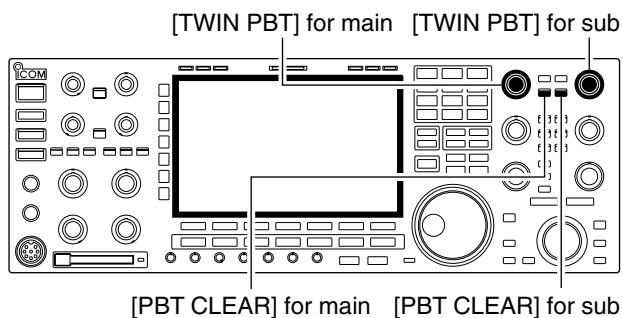

In general PBT (Passband Tuning) electronically narrows the IF passband width by shifting the IF frequency to slightly outside of the IF filter passband to reject interference. The IC-7800 uses DSP for the PBT function. Moving both [TWIN PBT] controls to the same position shifts the IF.

- The LCD shows the passband width and shift frequency graphically.
- Push [FILTER] for 1 sec. to enter the filter set screen. Current passband width and shift frequency is displayed in the filter set screen.
- To set the [TWIN PBT] controls to the center positions, push [PBT CLR] for 1 sec.

The variable range depends on the passband width and mode. The edge of the variable range is half of the passband width, and PBT is adjustable in 25 or 50 Hz steps.

Shows filter width, shifting value and condition



- [TWIN PBT] should normally be set to the center positions (PBT setting is cleared) when there is no interference.
- When PBT is used, the audio tone may be changed.
- Not available for FM mode.
- While rotating [TWIN PBT], noise may occur. This comes from the DSP unit and does not indicate an equipment malfunction.

• PBT operation example

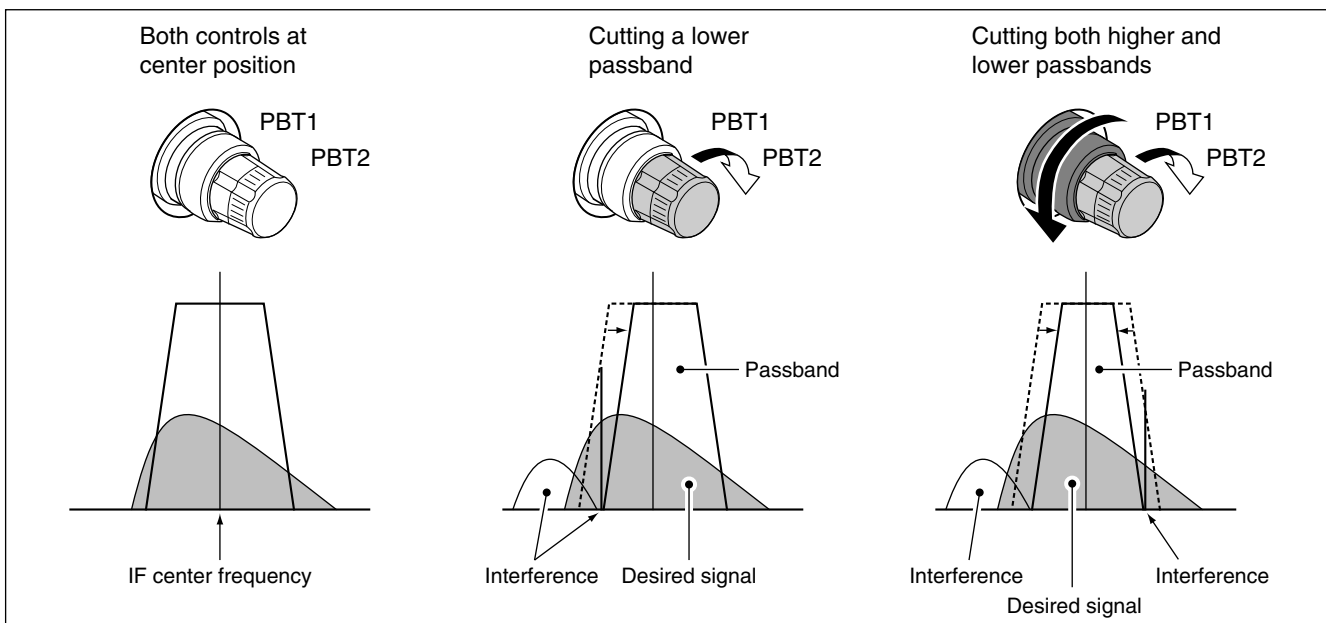

IF filter selection

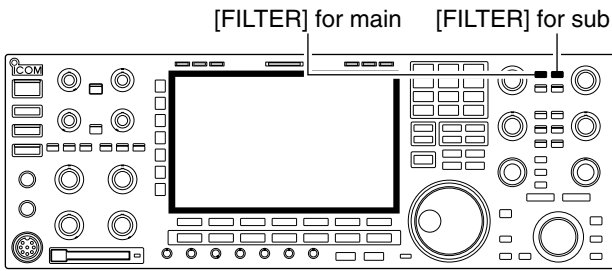

The transceiver has 3 passband width IF filters for each mode.

For SSB, CW and PSK modes, the passband width can be set within 50 to 3600 Hz in 50 or 100 Hz steps. A total of 41 passband widths are available.

For RTTY mode, the passband width can be set within 50 to 2700 Hz in 50 or 100 Hz steps. A total of 32 passband widths are available.

For AM mode, the passband width can be set within 200 Hz to 10 kHz in 200 Hz steps. A total of 50 passband widths are available.

For FM mode, the passband width is fixed and 3 passband widths are available.

- ▨ The filter selection is automatically memorized in each mode.
- ▨ The PBT shift frequencies are automatically memorized in each filter.

◇ IF filter selection

- ① Select the desired mode.
- ② Push [FILTER] several times to select the IF filter 1, 2 or 3.
 - The selected passband width and filter number is displayed in the LCD.

◇ Filter passband width setting (except FM mode)



- ① Push [FILTER] for 1 sec. to enter filter set screen.
- ② Select any mode except FM.
 - Passband widths for FM modes are fixed and cannot be set.
- ③ Push [FILTER] several times to select the desired IF filter.
- ④ While pushing [F-1•BW], rotate the main dial to set the desired passband width.
 - In SSB, CW and PSK modes, the passband width can be set within the following range.
 - 50 to 500 Hz 50 Hz steps
 - 600 to 3600 Hz 100 Hz steps
 - In RTTY mode, the passband width can be set within the following range.
 - 50 to 500 Hz 50 Hz steps
 - 600 to 2700 Hz 100 Hz steps
 - In AM mode, the passband width can be set within the following range.
 - 200 Hz to 10 kHz 200 Hz steps
 - Push [F-4•DEF] for 1 sec. to select the default value.
- ⑤ Repeat steps ② to ④ if desired.
- ⑥ Push [EXIT/SET] to exit filter set screen.

- ▨ The PBT shift frequencies are cleared when the passband width is changed.

- ▨ This filter set screen graphically displays the PBT shift frequencies and CW pitch operations.

5 FUNCTIONS FOR RECEIVE

◇ Roofing filter selection



The IC-7800 has 3, 6 and 15 kHz roofing filters at the 1st IF frequency. The roofing filter provides interference reduction from nearby strong signals.

- ① Push [FILTER] for 1 sec. to enter filter set screen.
- ② Select any mode except FM.
- ③ Push [F-6•ROOFING] to select the desired filter width from 15 kHz (default), 6 kHz and 3 kHz.
 - Push [F-4•DEF] for 1 sec. to select a default value.
- ④ Push [EXIT•SET] to exit filter set screen.

◇ DSP filter shape



The type of DSP filter shape for each SSB, SSB data and CW can be selected independently from soft and sharp.

- ① Push [FILTER] for 1 sec. to enter filter set screen.
- ② Select SSB, SSB data or CW mode.
- ③ Push [F-7•SHAPE] to select the desired filter shape from soft and sharp.
- ④ Push [EXIT•SET] to exit filter set screen.

The filter shape can be set for each band (HF and 50 MHz bands), mode, as well as the passband width setting (CW only) independently as your default setting in filter shape set mode.

◇ Filter shape set mode



The type of DSP filter shape for each SSB, SSB data and CW can be selected independently from soft and sharp.

- ① Push [FILTER] for 1 sec. to enter filter set screen.
- ② Push [F-7•SHAPE] for 1 sec. to enter filter shape set mode.
- ③ Push [F-1•▲] or [F-2•▼] to select the desired item.
- ④ Rotate the main dial to select the filter shape from soft and sharp.
- ⑤ Push [EXIT/SET] to exit filter shape set mode.

HF SSB (600Hz -)

Select the filter shape for SSB mode in HF bands.

SHARP

▨ The set filter shape is automatically used only when the IF filter is set to 600 Hz or wider.

SSB-D (600Hz -)

Select the filter shape for SSB data mode in HF bands.

SHARP

▨ The set filter shape is automatically used only when the IF filter is set to 600 Hz or wider.

◇ Filter shape set mode (continued)

CW (- 500Hz)

Select the filter shape for CW mode in HF bands.

SHARP

▨ The set filter shape is automatically used only when the IF filter is set to 500 Hz or narrower.

CW (600Hz -)

Select the filter shape for CW mode in HF bands.

SHARP

▨ The set filter shape is automatically used only when the IF filter is set to 600 Hz or wider.

50M SSB (600Hz -)

Select the filter shape for SSB mode in 50 MHz band.

SOFT

▨ The set filter shape is automatically used only when the IF filter is set to 600 Hz or wider.

SSB-D (600Hz -)

Select the filter shape for SSB data mode in 50 MHz band.

SHARP

▨ The set filter shape is automatically used only when the IF filter is set to 600 Hz or wider.

CW (- 500Hz)

Select the filter shape for CW mode in 50 MHz band.

SHARP

▨ The set filter shape is automatically used only when the IF filter is set to 500 Hz or narrower.

CW (600Hz -)

Select the filter shape for CW mode in 50 MHz band.

SHARP

▨ The set filter shape is automatically used only when the IF filter is set to 600 Hz or wider.

Dualwatch operation

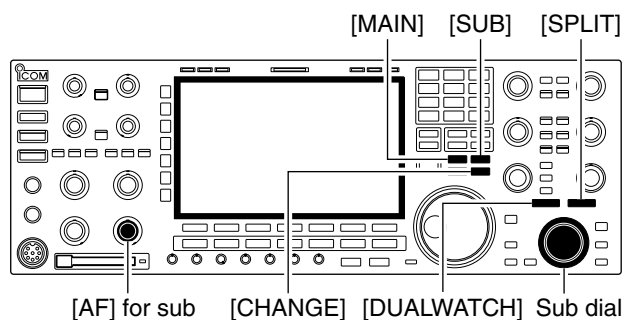

Split frequency operation during dualwatch



Dualwatch monitors 2 frequencies simultaneously. The IC-7800 has 2 independent receiver circuits so that you can use dualwatch with no compromises, even on different bands and modes.

- ① Set the desired frequency and mode into the main band.
- ② Push [DUALWATCH].
 - “DUAL-W” appears.
 - Pushing [DUALWATCH] for 1 sec., the sub band is equalized at the same time. This quick dualwatch function can be turned OFF in set mode. (p. 12-14)
- ③ Rotate the sub dial to set the desired frequency.
- ④ Push [SUB] to enables the sub band access when changing the frequency band, operating mode, etc. in sub band.
 - Push [MAIN] for the main band access.
- ⑤ Rotate [AF] for sub band to adjust the sub band audio level.
- ⑥ To transmit on the sub band readout, push [CHANGE] or [SPLIT].

- NOTE:**
- A beat note may be heard depending on the frequency combination.
 - Receiver sensitivity will be decreased when the same frequency band and the same antenna are selected during dualwatch.
 - The RIT function can be used for the main readout only.
 - The Δ TX function can be used for the transmit readout (main readout when the split function OFF; sub readout when the split function ON).

■ Noise blanker

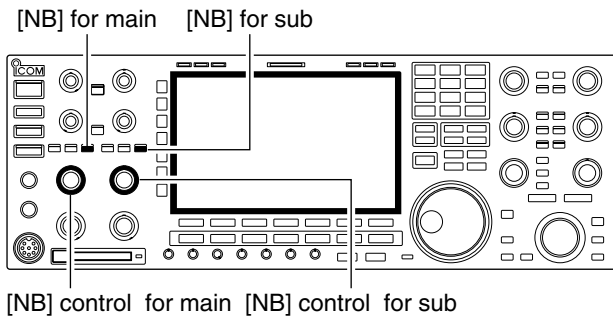

The noise blanker eliminates pulse-type noise such as the noise from car ignitions. The noise blanker is not available for FM mode.

- ① Push [NB] to turn the noise blanker function ON and OFF.
 - [NB] indicator above their switch lights green.
- ② Rotate [NB] control to adjust the noise blanker threshold level.

When using the noise blanker, received signals may be distorted if they are excessively strong or the noise type is other than impulse. Turn the noise blanker OFF, or rotate [NB] control to a shallow position in this case.

◇ NB set mode

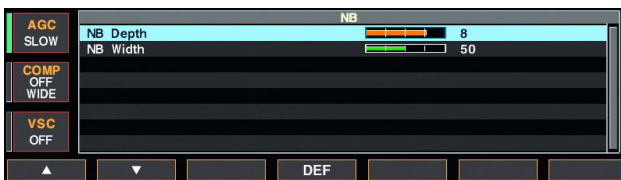

To deal with various type of noises, attenuation level and noise width can be set in NB set mode.

- ① Push [NB] for 1 sec. to enter NB set mode.
- ② Push [F-1•▲] or [F-2•▼] to select the desired item.
- ③ Rotate the main dial to set the desired level or value.
 - Push [F-4•DEF] for 1 sec. to select a default value.
- ④ Push [EXIT/SET] to exit NB set mode.

NB Depth  8
Set the noise attenuation level from 1 to 10.

NB Width  50
Set the noise pulse width from 1 to 100.

■ Noise reduction

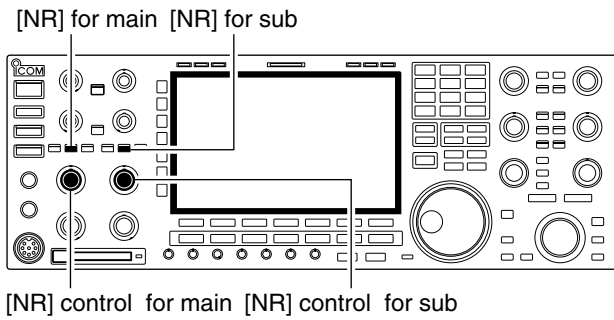

The noise reduction function reduces random noise components and enhances desired signals which are buried in noise. The DSP does the random noise reduction function.

- ① Push the [NR] to turn the noise reduction ON.
 - [NR] indicator above their switch lights green.
- ② Rotate the [NR] control to adjust the noise reduction level.
- ③ Push the [NR] switch to turn the noise reduction OFF.
 - [NR] indicator lights off.

⚠ Deep rotation of the [NR] control results in audio signal masking or distortion. Set the [NR] control for maximum readability.

■ Dial lock function

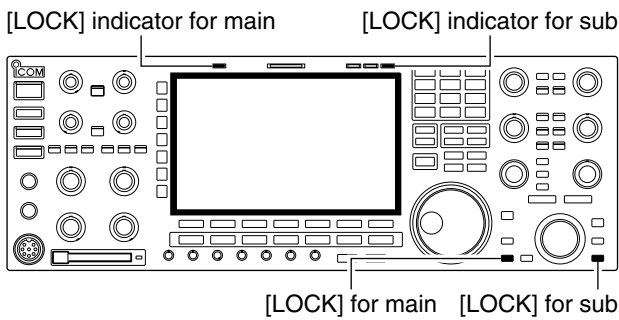

The dial lock function prevents frequency changes by accidental movement of the tuning dial. The lock function electronically locks the dial.

- ➡ Push [LOCK] to toggle the dial lock function ON and OFF.
 - The [LOCK] indicator lights when the dial lock function is in use.

Notch function

[NOTCH] control for main [NOTCH] control for sub

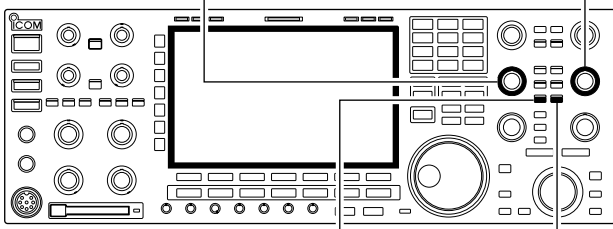

[NOTCH] for main [NOTCH] for sub

This transceiver has auto and manual notch functions. The auto notch function uses DSP to automatically attenuates more than 3 beat tones, tuning signals, etc., even if they are moving. The manual notch can be set to attenuate a frequency via the [NOTCH] control. The auto notch can be used in SSB, AM and FM modes. The manual notch can be used in SSB, CW, RTTY, PSK and AM modes.

Auto notch indication



Manual notch indication



- ➔ Push [NOTCH] to toggle the notch function between auto, manual and OFF in SSB and AM modes.
- ➔ Push [NOTCH] to turn the manual notch function ON and OFF in CW mode.
- ➔ Push [NOTCH] to turn the auto notch function ON and OFF in FM mode.
 - [NOTCH] indicator above their switch lights green.
 - Push [NOTCH] for 1 sec. to select the notch filter width for manual notch from wide, middle and narrow.
 - Set to attenuate a frequency for manual notch via the [NOTCH] control.
 - “AN” appears when auto notch is in use.
 - “MN” appears when manual notch is in use.

⚡ While tuning the manual notch, noise may be heard. This comes from the DSP unit and does not indicate an equipment malfunction.

Digital selector

[DIGI-SEL] control for main [DIGI-SEL] control for sub

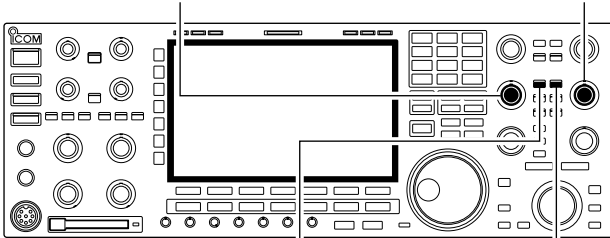

[DIGI-SEL] for main [DIGI-SEL] for sub

The digital selector manually adjusts the center frequency of the automatic pre-selector.

The automatic pre-selector adds selectivity ahead of the 1st mixer. This reduces intermodulation distortion from the nearby strong signals.

The automatic pre-selector tracks the frequency tuning, changing its resonant frequency in discrete steps.

- ① Push [DIGI-SEL] to turn the digital selector ON and OFF.
 - [DIGI-SEL] indicator above their switch lights green.
- ② Rotate [DIGI-SEL] control to adjust the center frequency.

⚡ **NOTE:**

- When rotating the main dial (or sub dial during dual-watch or split function) while the digital selector is activated, mechanical noise may be heard due to the switching noise from internal relays.
- The preamp (P.AMP1 or P.AMP2) cannot be used while the digital selector is activated.

■ VOX function	6-2
◇ Using the VOX function	6-2
◇ Adjusting the VOX function	6-2
◇ VOX set mode	6-2
■ Break-in function	6-3
◇ Semi break-in operation	6-3
◇ Full break-in operation	6-3
■ ΔTX function	6-4
◇ ΔTX monitor function	6-4
■ Monitor function	6-4
■ Transmit filter width setting (SSB only)	6-5
■ Speech compressor (SSB only)	6-5
■ Split frequency operation	6-6
■ Quick split function	6-7
◇ Split lock function	6-7

■ VOX function

The VOX (Voice-Operated Transmission) function switches between transmit and receive with your voice. This function provides “hands-free” operation.

◇ Using the VOX function

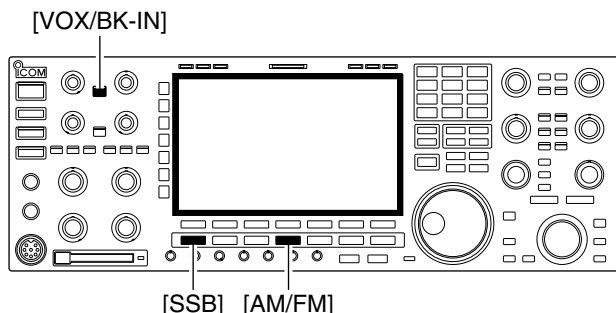

- ① Select a phone mode (SSB, AM, FM).
- ② Push [VOX/BK-IN] to turn the VOX function ON or OFF.
 - “VOX” appears while the VOX is in use.
 - [VOX/BK-IN] indicator above this switch lights green.

◇ Adjusting the VOX function

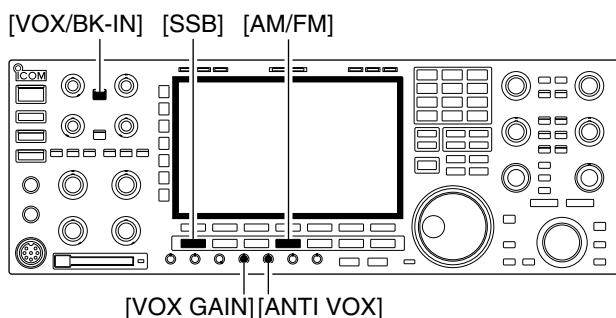

- ① Select a phone mode (SSB, AM, FM).
- ② Push [VOX/BK-IN] to turn VOX function ON.
- ③ While speaking into the microphone with your normal voice level, rotate [VOX GAIN] to the point where the transceiver is continuously transmitting.
- ④ During receive, rotate [ANTI VOX] to the point where the transceiver does not switch to transmit due to received audio from the speaker.
- ⑤ Adjust the VOX delay and the VOX voice delay in VOX set mode, if necessary.

◇ VOX set mode



- ① Push [VOX/BK-IN] for 1 sec. to enter VOX set mode.
- ② Select the desired item using [F-1•▲] or [F-2•▼].
- ③ Rotate the main dial to the desired set value or condition.
 - Push [F-4•DEF] for 1 sec. to select a default value.
- ④ Push [EXIT/SET] to exit VOX set mode.

VOX Delay 0.2s

Set the VOX delay for a convenient interval before returning to receive within 0 to 2.0 sec. range.

VOX Voice Delay Short

Set the VOX voice delay to prevent mis-transmission of your voice when switching to transmit. Short, Mid., Long and OFF settings are available.

When using the VOX voice delay, turn the TX monitor function OFF, the transmitted audio will be echoed.

■ Break-in function

The break-in function is used in CW mode to automatically toggle the transceiver between transmit and receive when keying. The IC-7800 is capable for full break-in or semi break-in.

◇ Semi break-in operation

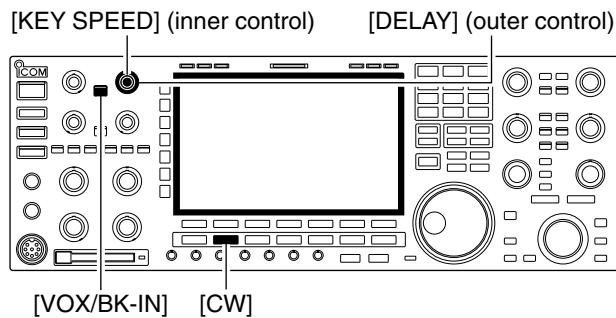

During semi break-in operation, the transceiver selects transmit when keying, then automatically returns to receive after a pre-set time after you stop keying.

- ① Push [CW] to select CW or CW-R mode.
- ② Push [VOX/BK-IN] several times to turn the semi break-in function ON.
 - “BK IN” appears.
- ③ Rotate [DELAY] to set the break-in delay time (the delay from transmit to receive).

▨ When using a paddle, rotate [KEY SPEED] to adjust the keying speed.

◇ Full break-in operation



During full break-in operation, the transceiver automatically selects transmit while keying and returns to receive immediately after keying is finished.

- ① Push [CW] to select CW or CW-R mode.
- ② Push [VOX/BK-IN] several times to turn the full break-in function ON.
 - “F-BK IN” appears.

▨ When using a paddle, rotate [KEY SPEED] to adjust the keying speed.

■ ΔTX function

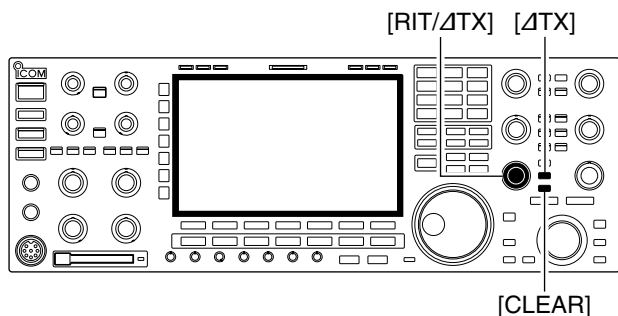

The ΔTX function shifts the transmit frequency up to ±9.999 kHz in 1 Hz steps (10 Hz steps when cancelling the 1 Hz step readout) without moving the receive frequency.

• See ③ on p. 1-11 for function description.

- ① Push [ΔTX].
 - “ΔTX” appears.
- ② Rotate [RIT/ΔTX].
- ③ To reset the ΔTX frequency, push [CLEAR] for 1 sec.
 - Push [CLEAR] momentarily to reset the RIT frequency when the quick RIT/ΔTX clear function is ON. (p. 12-1)
- ④ To cancel the ΔTX function, push [ΔTX] again.
 - “ΔTX” disappears.

◇ ΔTX monitor function

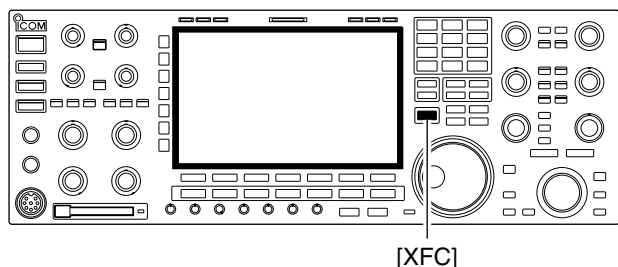

When the ΔTX function is ON, pushing and holding [XFC] allows you to monitor the operating frequency directly (ΔTX is temporarily cancelled).

✓ For your convenience— Calculate function

The shift frequency of the ΔTX function can be added/subtracted to the displayed frequency.

- ➔ While displaying the ΔTX shift frequency, push [ΔTX] for 1 sec.

■ Monitor function

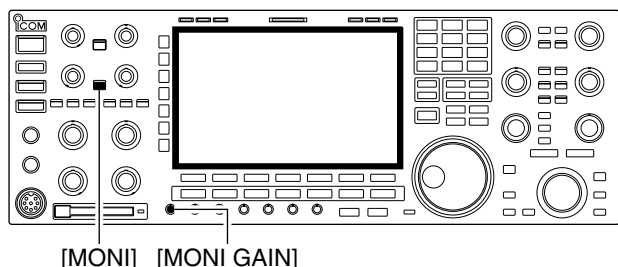

The monitor function allows you to monitor your transmit IF signals in any mode. Use this to check voice characteristics while adjusting SSB transmit parameter. (p. 12-4) The CW sidetone functions regardless of the [MONI] switch setting.

- ① Push [MONI] to switch the monitor function ON and OFF.
 - [MONI] indicator above this switch lights green.
- ② Rotate [MONI GAIN] for the clearest audio output while pushing [PTT] and speaking into the microphone.

⚠ **NOTE:** When using the VOX voice delay, turn the monitor function OFF; or transmitted audio will be echoed.

■ Transmit filter width setting (SSB only)

The transmit filter width for SSB mode can be selected from wide, middle and narrow.

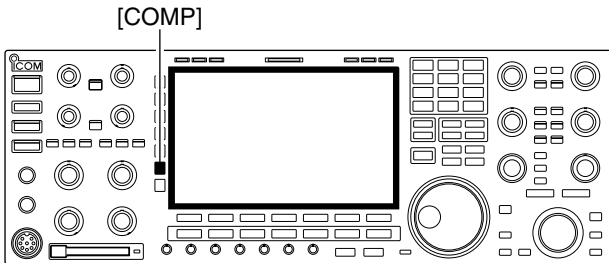

➔ During USB or LSB mode selection, push [COMP] for 1 sec. several times to select the desired transmit filter width from wide, middle and narrow.

- The filter functions regardless of the speech compressor use.

- The following filters are specified as the default. Each of the filter width can be re-set in level set mode. (p. 12-5)

WIDE : 100 Hz to 2.9 kHz

MID : 300 Hz to 2.7 kHz

NAR : 500 Hz to 2.5 kHz

■ Speech compressor (SSB only)

The speech compressor increases average RF output power, improving signal strength and readability in SSB mode only.

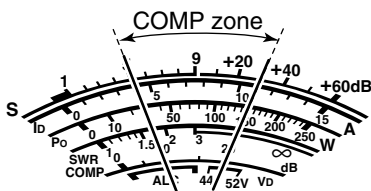
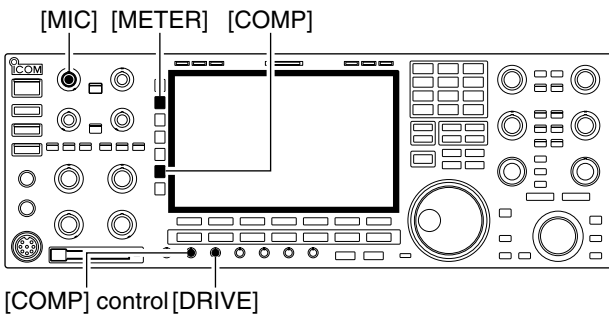

① Select USB or LSB mode and adjust [MIC] to a suitable level.

- Push [METER] several times to select the ALC meter for microphone gain adjustment.

② Push [COMP] to turn the speech compressor ON.

③ Push [METER] once to select the COMP meter.

④ While speaking into the microphone, rotate [COMP] control, so that the COMP meter reads within the COMP zone (10 to 20 dB range) with your normal voice level.

⚠ When the COMP meter peaks exceed the COMP zone, your transmitted voice may be distorted.

⑤ Push [METER] 5 times to select the ALC meter.

⑥ While speaking into the microphone, rotate [DRIVE], so that the ALC meter reads within the 30 to 50% range of the ALC zone with your normal voice level.

✓ For your convenience

Push [METER] for 1 sec. to display the multi-function meter that can check the ALC and COMP level at a glance.

■ Split frequency operation

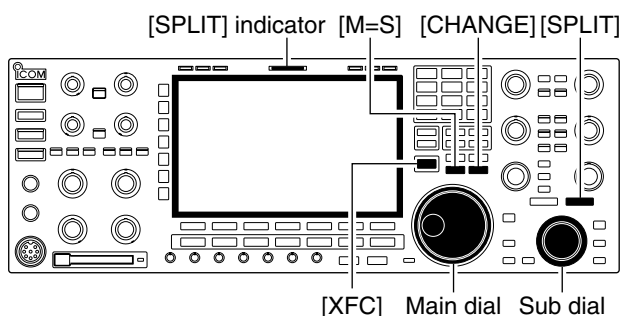

• When the split function ON



• When [XFC] is pushed



• The split frequency operation is ready



Split frequency operation allows you to transmit and receive in the same mode on two different frequencies. The split frequency operation is performed using 2 frequencies on the main and sub readouts.

The following is an example of setting 21.290 MHz for receiving and 21.310 MHz for transmitting.

- ① Set 21.290 MHz (USB) in VFO mode.
- ② Push [SPLIT] momentarily, then push [M=S] for 1 sec.
 - The quick split function is much more convenient for selecting the transmit frequency. See the next section for details.
 - The equalized transmit frequency and “**SPLIT**” appear on the LCD.
 - [SPLIT] indicator lights.
 - “TX” appears to show the transmit frequency readout.
- ③ Set the transmit frequency to 21.310 MHz in one of following ways.
 - Rotate the main dial while pushing [XFC].
 - Rotate the sub dial.
 - The transmit frequency can be monitored while pushing [XFC] or using dualwatch.
- ④ Now you can receive on 21.290 MHz and transmit on 21.310 MHz.

To change the transmit and receive frequencies, push [CHANGE] to exchange the main and sub readouts.

✓ CONVENIENT

• Direct shift frequency input

The shift frequency can be entered directly.

- ① Push [F-INP•ENT].
 - ② Enter the desired shift frequency with the digit keys.
 - 1 kHz to 1 MHz can be set.
 - When you require a minus shift direction, push [GENE•.] in advance.
 - ③ Push [SPLIT].
 - The shift frequency is input in the sub readout and the split function is turned ON.
- [Example]
 To transmit on 1 kHz higher frequency:
 - Push [F-INP•ENT], [1.8•1] then [SPLIT].
 To transmit on 3 kHz lower frequency:
 - Push [F-INP•ENT], [GENE•.], [7•3] then [SPLIT].

• Split lock function

Accidentally releasing [XFC] while rotating the main dial changes the receive frequency. To prevent this, use both the split lock and dial lock functions to change the transmit frequency only. The split lock function cancels the dial lock function while pushing [XFC] during split frequency operation.

The dial lock's effectiveness during split frequency operation can be selected in the set mode for both receive and transmit frequencies; or only the receive frequency. (p. 12-15)

■ Quick split function

When you find a DX station, an important consideration is how to set the split frequency.

When you push the [SPLIT] switch for 1 sec., split frequency operation is turned ON, the sub readout is equalized to the main readout frequency and enters standby for transmit frequency input.

This shortens the time needed to start split frequency operation.

The quick split function is ON by default. For your convenience, it can be turned OFF in set mode. (p. 12-15) In this case, the [SPLIT] switch does not equalize the main and sub readout frequencies.

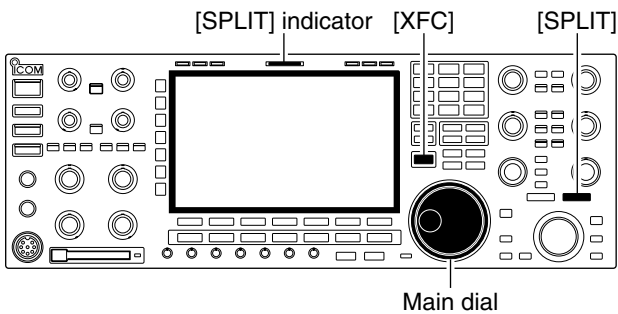

- ① Suppose you are operating at 21.290 MHz (USB) in VFO mode.
- ② Push [SPLIT] for 1 sec.
 - Split frequency operation is turned ON.
 - The sub readout is equalized to the main readout frequency.
 - “**F-INP**” indicator appears and the sub readout enters standby for transmit frequency input.
- ③ Enter the desired offset frequency from the keypad then push [SPLIT], or set the transmit frequency with the main dial while pushing [XFC], or with the sub dial.
 - “**F-INP**” indicator disappears when [XFC] is pushed or the main/sub dial is rotated.
 - Offset frequency setting with the keypad— example
 To transmit on 1 kHz higher frequency:
 - Push [F-INP•ENT], [1.8•1] then [SPLIT].
 To transmit on 3 kHz lower frequency:
 - Push [F-INP•ENT], [GENE•.], [7•3] then [SPLIT].

◇ Split lock function

The split lock function is convenient for changing only the transmit frequency. When the split lock function is not used, accidentally releasing [XFC] while rotating the main dial, changes the receive frequency. The split lock function is ON by default, but can be turned OFF in set mode. (p. 12-15)

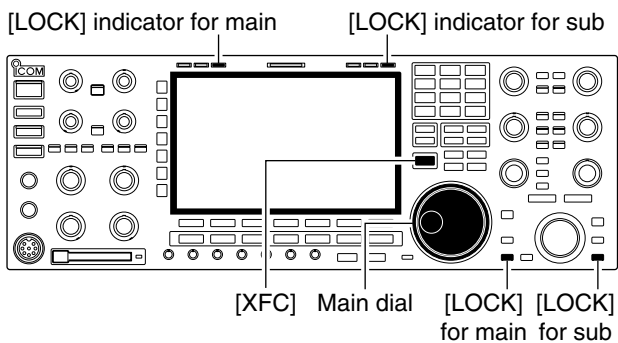

- ① While split frequency operation is ON, push [LOCK] for both main and sub band to activate the split lock function.
- ② While pushing [XFC], rotate the main dial to change the transmit frequency.
 - If you accidentally release [XFC] while rotating the main dial, the receive frequency does NOT change.

■ About digital voice recorder	7-2
■ Recording a received audio	7-3
◇ Basic recording	7-3
◇ One-touch recording	7-3
■ Playing the recorded audio	7-4
◇ Basic playing	7-4
◇ One-touch playing	7-4
■ Protect the recorded contents	7-5
■ Erasing the recorded contents	7-5
■ Recording a message for transmit	7-6
◇ Recording	7-6
◇ Confirming a message for transmit	7-6
■ Programming a memory name	7-7
■ Sending a recorded message	7-8
◇ Transmit level setting	7-8
■ Voice set mode	7-9
■ Saving a voice memory into the CF card	7-10
◇ Saving the received audio memory	7-10
◇ Saving the TX memory	7-10

■ About digital voice recorder

The IC-7800 has digital voice memories, up to 4 channels for transmit, and up to 20 channels for receive. A maximum message length of 30 sec. can be recorded into a receive channel (total message length for all channels of up to 209 sec.) and a total message length of up to 99 sec. can be recorded in transmit channels.

The transmit memory is very convenient for repeated CQ and number transmissions in contests, as well as when making consecutive calls during DX'peditions.

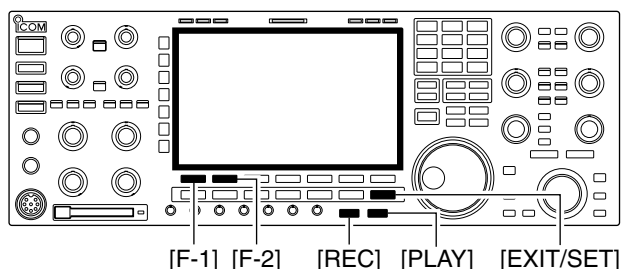

- ① Select any mode.
- ② Push [F-2•VOICE] to display voice recorder screen.
- ③ Push [EXIT/SET] to display voice recorder menu.
- ④ Push [F-1•PLAY] or [F-2•MIC REC] to select the desired memory channel screen, then record audio or playback the contents as described below.
- ⑤ Push [EXIT/SET] twice to exit voice recorder screen.

• Example— When [REC] is pushed for 1 sec.

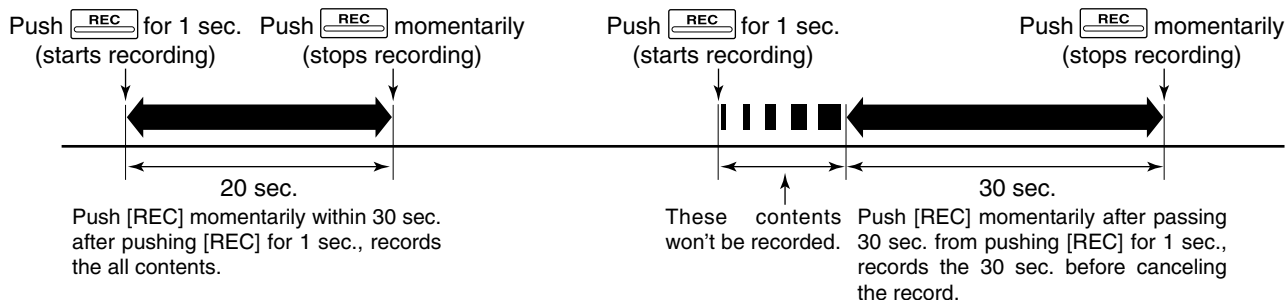

• Example— When [REC] is pushed momentarily

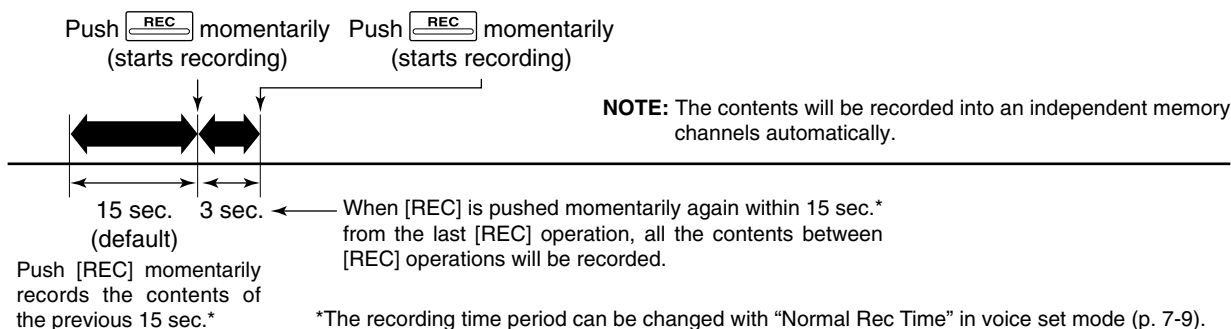

• Playing back the all contents in a channel

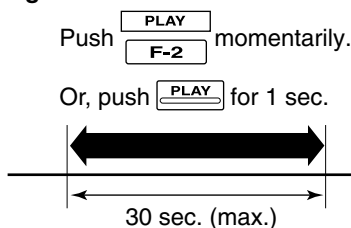

• Playing back the end of 5 sec.* in a channel

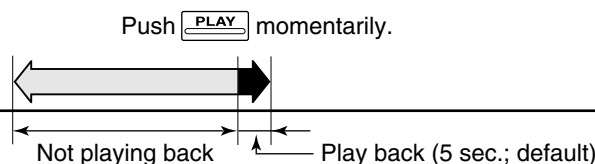

*The playing back time period can be changed with "Short Play Time" in voice set mode (p. 7-9).

■ Recording a received audio

Up to 20 channels of receive voice memories are available in the IC-7800. And the total audio length of up to 209 sec. can be recorded in receive channels. However, the maximum recordable length into a single channel is 30 sec.

This voice recorder records not only the received audio, but also the information such as set operating frequency, mode, and the recording time for your future reference.

◇ Basic recording

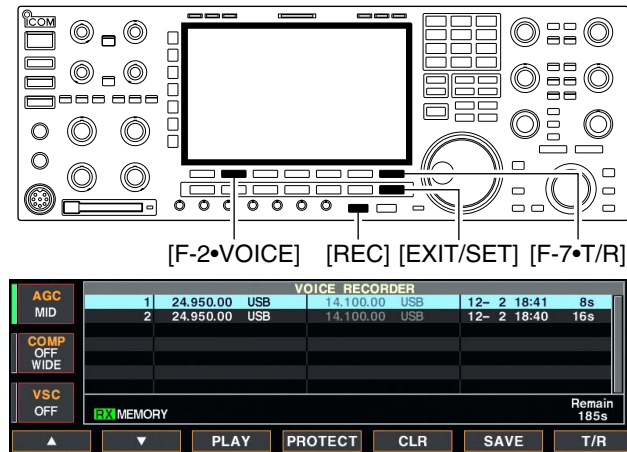

- ① Push [EXIT/SET] several times to close a multi-function screen, if necessary.
- ② Select the desired mode.
- ③ Push [F-2•VOICE] to call up the voice recorder screen.
 - Previously selected screen, TX or RX memory, is displayed. If the TX memory channel (T1–T4) appears, push [F-7•T/R] to select RX memory channel.
- ④ Push [REC] for 1 sec. to start recording.
 - The operating frequency, mode and current time are programmed as the memory names automatically.
- ⑤ Push [REC] momentarily to stop recording.

IMPORTANT!

Push [REC] to stop recording before, or when 30 sec. has passed from the start of recording. The voice recorder memory records the 30 sec. (max.) of audio before [REC] is pushed. For example, when recording 40 sec. of audio, the first 10 sec. audio will be over-recorded with the last 10 sec., so that the total of audio recorded is 30 sec. only. When you record the 21st audio segment, or when the total audio length exceeds 209 sec., the oldest recorded audio is automatically erased to make room for the new audio.

- ⑥ Push [EXIT/SET] twice to exit the voice recorder screen.

NOTE: When transmit (or [PTT] is pushed) while recording, no audio will be recorded.

◇ One-touch recording

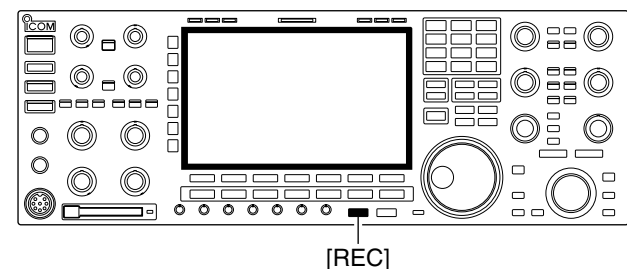

To record the receiving signal contents immediately, one-touch voice recording is available.

- ➔ Push [REC] momentarily to records the previous 15 sec. audio.
 - The recordable time period can be set in voice set mode. (p. 7-9)

■ Playing the recorded audio

◇ Basic playing

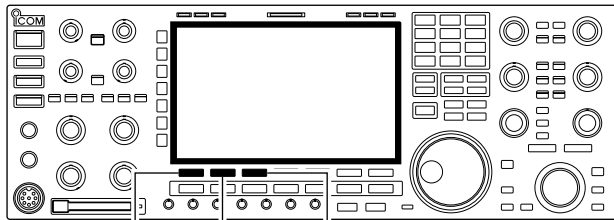

[F-1▲] [F-2▼] [F-3•PLAY]

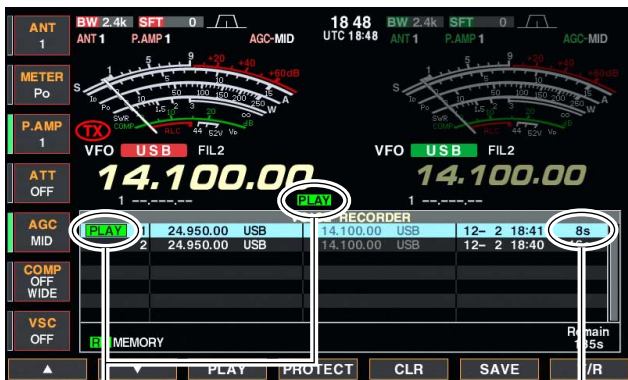

Appear

Counts down

- ① Push [EXIT/SET] several times to close a multi-function screen, if necessary.
- ② Push [F-2•VOICE] to call up the voice recorder screen.
 - Previously selected screen, TX or RX memory, is displayed. If the TX memory channel (T1–T4) appears, push [F-7•T/R] to select RX memory channel.
- ③ Push [F-1▲] or [F-2▼] to select the desired voice memory to playback.
- ④ Push [F-3•PLAY] to start playback.
 - “PLAY” indicators appear and the timer counts down.
- ⑤ Push [F-3•PLAY] again to stop playback if desired.
 - Playback is terminated automatically when all of the recorded contents in the channel are played, or after 30 sec.
- ⑥ Push [EXIT/SET] twice to exit the voice recorder screen.

◇ One-touch playing

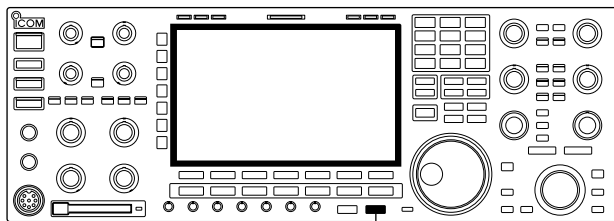

[PLAY]

The previously recorded audio in channel 1 can be playback without selecting voice recorder screen.

- Push [PLAY] momentarily to playback the last 5 sec. of the previously recorded audio.
 - “PLAY” indicator appears.
 - Playback is terminated automatically when all of the recorded contents in the channel are played, or after 5 sec.
 - The playback time period can be set in voice set mode. (p. 7-9)

■ Protect the recorded contents

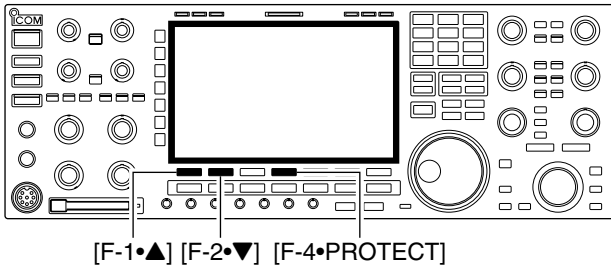

The protect function is available to protect the recorded contents from accidental erasing, such as over-record, etc.

- ① Call up the voice recorder screen, RX memory.
- ② Push [F-1•▲] or [F-2•▼] to select the desired voice memory.
- ③ Push [F-4•PROTECT] to turn the protect function ON and OFF.
 - “” indicator appears when the contents is protected.
- ④ Push [EXIT/SET] twice to exit the voice recorder screen.

■ Erasing the recorded contents

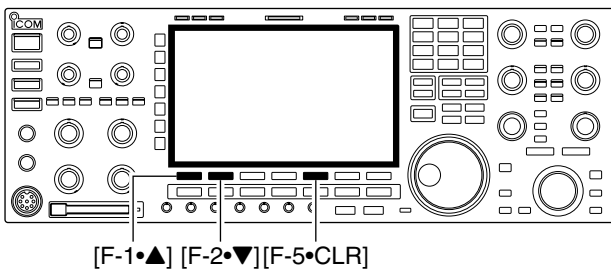

The recorded contents can be erased independently by channel.

- ① Call up the voice recorder screen, RX memory.
- ② Push [F-1•▲] or [F-2•▼] to select the desired voice memory to be erased.
- ③ Push [F-5•CLR] for 1 sec. to erase the contents.
 - Push [F-4•PROTECT] to release the protection in advance if necessary.
- ④ Push [EXIT/SET] twice to exit the voice recorder screen.

■ Recording a message for transmit

To transmit a message using the voice recorder, record the desired message in advance as described below. The IC-7800 has digital voice memories for transmission, up to 4 channels and the total message length of up to 99 sec. can be recorded.

◇ Recording

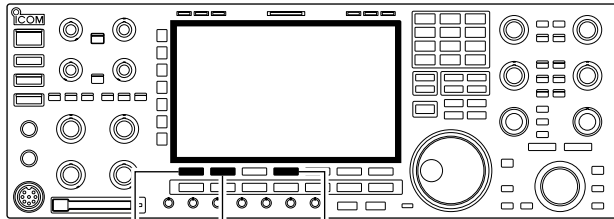

[F-1•▲] [F-2•▼] [F-4•REC]

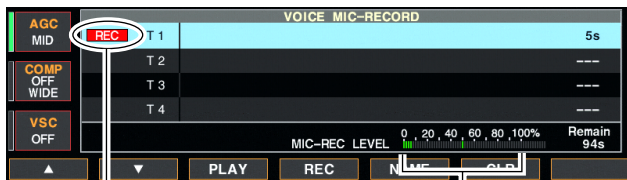

Appears

Adjust [MIC] control so that this indicator reads within 100%.

- ① Push [EXIT/SET] several times to close a multi-function screen, if necessary.
- ② Push [F-2•VOICE] to call up the voice recorder screen.
- ③ Push [EXIT/SET] to select voice recorder menu.
- ④ Push [F-2•MIC REC] to select the voice mic. record screen.
- ⑤ Push [F-1•▲] or [F-2•▼] to select the desired memory channel.
- ⑥ Push [F-4•REC] for 1 sec. to start recording.
 - "REC" indicator appears.
 - Speak into the microphone without pushing [PTT].
 - Previously recorded contents are cleared.
 - Audio output from the internal speaker is automatically muted.
- ⑦ While speaking into the microphone with your normal voice level, adjust the [MIC] control so that the [MIC-REC LEVEL] indicator reads within 100%.
- ⑧ Push [F-4•REC] momentarily to stop recording.
 - The recording is terminated automatically when the remaining time becomes 0 sec.
- ⑨ Push [EXIT/SET] twice to exit the voice recorder screen.

◇ Confirming a message for transmit

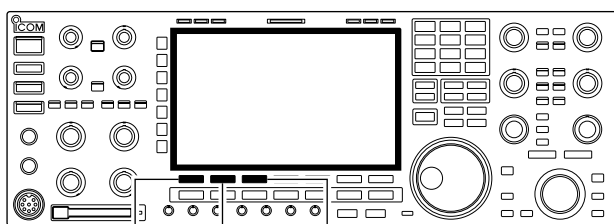

[F-1•▲] [F-2•▼] [F-3•PLAY]

- ① Perform the steps ① to ④ as "◇ Recording" above.
- ② Push [F-1•▲] or [F-2•▼] to select the desired memory channel.
- ③ Push [F-3•PLAY] to playback the recorded contents.
 - "PLAY" indicator appears.
- ④ Push [F-3•PLAY] again to stop playback.
 - Playback is terminated automatically when all of the recorded contents in the channel are played.
- ⑤ Push [EXIT/SET] twice to exit the voice recorder screen.

■ Programming a memory name

Memory channels can be tagged with alphanumeric names of up to 20 characters each.

Capital letters, small letters, numerals, some symbols (! # \$ % & ¥ ? “ ‘ ^ + - * / . , ; = < > () [] { } | _ ~ @) and spaces can be used. (See the table below.)

[ABC]/[abc]/[123]/[Symbol] [F-3•DEL] Keypad

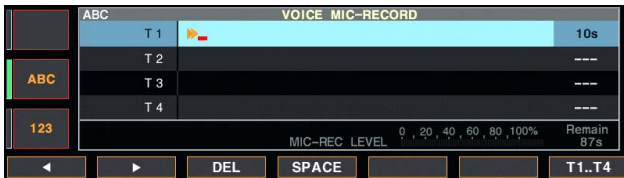
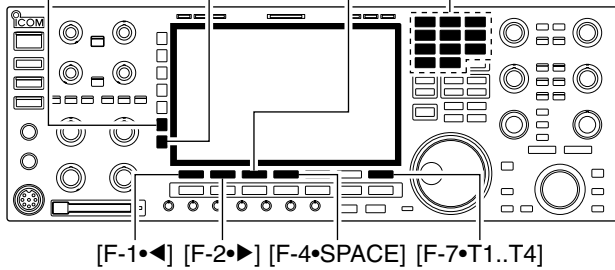

• Voice memory name editing example



- ① Record a message as described in page 7-6.
- ② During the voice mic. record screen indication, push [F-5•NAME] to enter memory name edit condition.
 - A cursor appears and blinks.
- ③ Push [F-7•T1..T4] several times to select the desired voice memory.
- ④ Input the desired character by rotating the main dial or by pushing the band key for number input.
 - Push [ABC] or [abc] to toggle capital and small letters.
 - Push [123] or [Symbol] to toggle numerals and symbols.
 - Push [F-1•◀] or [F-2•▶] for cursor movement.
 - Push [F-3•DEL] to delete the selected character.
 - Push [F-4•SPACE] to input a space.
 - Pushing the transceiver’s keypad, [0]–[9], can also enter numerals.
- ⑤ Push [EXIT/SET] to input and set the name.
 - The cursor disappears.
- ⑥ Repeat steps ③ to ⑤ to program another voice memory’s name, if desired.
- ⑦ Push [EXIT/SET] twice to exit the voice recorder screen.

• Usable characters

Key selection	Editable characters
	A to Z (capital letters)
	a to z (small letters)
	0 to 9 (numbers)
	! # \$ % & ¥ ? “ ‘ ^ + - * / . , ; = < > () [] { } _ ~ @

■ Sending a recorded message

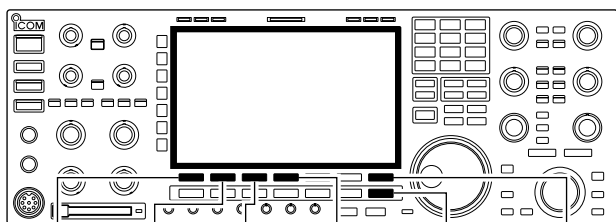

[F-1•T1] [F-2•T2] [F-3•T3] [F-4•T4] [EXIT/SET] [F-7•T/R]

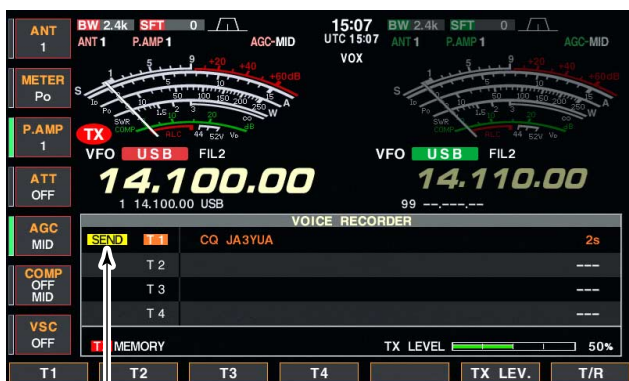

Appears

- ① Push [EXIT/SET] several times to close a multi-function screen, if necessary.
- ② Select a phone mode by pushing [SSB] or [AM/FM].
- ③ Push [F-2•VOICE] to call up the voice recorder screen.
 - If the receive voice memory channel appears, push [F-7•T/R] to select TX memory channel (T1–T4).
- ④ Push the desired memory channel switch, [F-1•T1] to [F-4•T4], momentarily to transmit the contents.
 - The transceiver transmits automatically.
 - “SEND” indicator appears and the memory timer counts down.
 - You hear the transmitted message from the speaker as the default. This can be turned OFF in voice set mode. (p. 7-9)
- ⑤ Push the selected memory channel switch, [F-1•T1] to [F-4•T4], again to stop, if desired.
 - The transceiver returns to receive automatically when all of the recorded contents in the channel are transmitted.
- ⑥ Push [EXIT/SET] twice to exit the voice memory screen.

✓ For your information

When an external keypad is connected to [EXT KEYPAD], the recorded message, T1–T4, can be transmitted without opening the voice recorder screen.

See page 2-6 for details.

◇ Transmit level setting

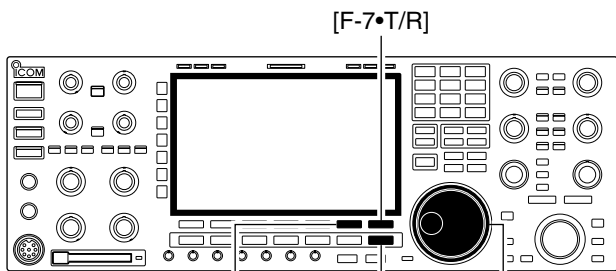

[F-6•TX LEV.] [EXIT/SET] Main dial



- ① Call up the voice recorder screen as described as above.
- ② Push [F-6•TX LEV.] to select the voice memory transmit level set condition.
- ③ Push the desired memory channel switch, [F-1•T1] to [F-4•T4], momentarily to transmit the contents.
 - The transceiver transmits automatically.
 - “SEND” indicator appears and the memory timer counts down.
- ④ Rotate the main dial to adjust the transmit voice level.
 - Push [F-7•DEF] for 1 sec. to select the default condition.
- ⑤ Push [EXIT/SET] to return to the voice recorder screen.

■ Voice set mode

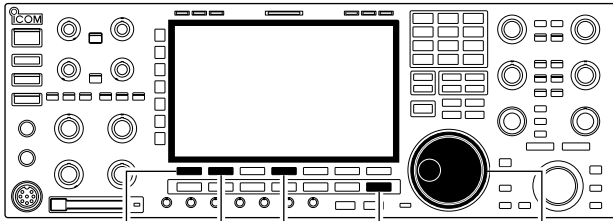

[F-1•▲] [F-2•▼] [F-4•DEF] [EXIT/SET] Main dial



Sets the automatic monitor function, short play and normal recording times for voice recorder.

- ① Push [EXIT/SET] several times to close a multi-function screen, if necessary.
- ② Push [F-2•VOICE] to call up the voice recorder screen.
- ③ Push [EXIT/SET] to select voice recorder menu.
- ④ Push [F-7•SET] to select voice set mode screen.
- ⑤ Push [F-1•▲] or [F-2•▼] to select the desired item.
- ⑥ Rotate main dial to set the desired condition or value.
 - Push [F-4•DEF] for 1 sec. to select the default condition or value.
- ⑦ Push [EXIT/SET] to exit the voice set mode screen.

Auto Monitor	ON
Turn the automatic monitor function for recorded audio contents transmission.	<ul style="list-style-type: none"> • ON : Monitors transmitting audio automatically when sending a recorded audio. • OFF : Monitors transmitting audio only when the monitor function is in use.

Short Play Time	5s
Set the desired time period for the one-touch playing (when [PLAY] is pushed momentarily).	<ul style="list-style-type: none"> • 3 to 10 sec. in 1 sec. steps can be set. (default: 5 sec.)

Normal Rec Time	15s
Set the desired time period for the for one-touch recording (when [REC] is pushed momentarily).	<ul style="list-style-type: none"> • 5 to 15 sec. in 1 sec. steps can be set. (default: 15 sec.)

■ Saving a voice memory into the CF memory card

◇ Saving the received audio memory

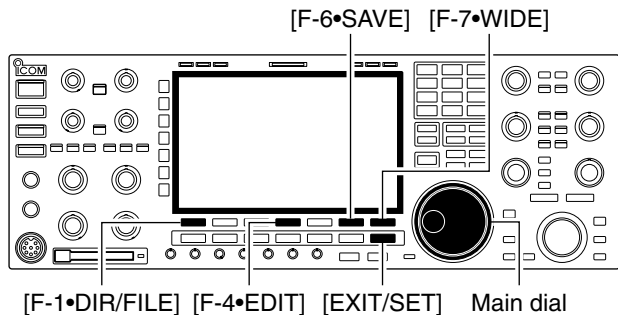

• Voice recorder RX memory screen



• Voice file save screen— file name edit



• While saving



◇ Saving the TX memory

The recorded RX memory contents can be saved into the CF (Compact Flash) memory card.

- ① During voice recorder RX memory screen display, push [F-6•SAVE] to select voice file save screen.
 - Previously selected screen, TX or RX memory, is displayed. If the TX memory channel (T1–T4) appears, push [F-7•T/R] to select RX memory channel.
- ② Change the following conditions if desired.

• File name:

- ① Push [F-4•EDIT] to select file name edit condition.
 - Push [F-1•DIR/FILE] several times to select the file name, if necessary.
- ② Push [ABC], [123] or [Symbol] to select the character group, then rotate the main dial to select the character.
 - [ABC] : A to Z (capital letters); [123]: 0 to 9 (numerals); [Symbol]: ! # \$ % & ' ` ^ + = () [] { } _ ~ @ can be selected.
 - Push [F-1•◀] to move the cursor left, push [F-2•▶] to move the cursor right, push [F-3•DEL] to delete a character and push [F-4•SPACE] to insert a space.
- ③ Push [EXIT/SET] to set the file name.

• Saving location

- ① Push [F-1•DIR/FILE] to select tree view screen.
- ② Select the desired directory or folder in the CF memory card.
 - Push [F-4•◀ ▶] to select the upper directory.
 - Push [F-2•▲] or [F-3•▼] to select folder in the same directory.
 - Push [F-4•◀ ▶] for 1 sec. to select a folder in the directory.
 - Push [F-5•REN/DEL] to rename the folder.
 - Push [F-5•REN/DEL] for 1 sec. to delete the folder.
 - Push [F-6•MAKE] for 1 sec. to making a new folder. (Edit the name with the same manner as the “• File name” above.)
- ③ Push [F-1•DIR/FILE] twice to select the file name.
- ③ Push [F-6•SAVE].
 - After the saving is completed, return to voice recorder RX memory screen automatically.

The TX memory contents can also be saved into the CF (Compact Flash) memory card. However, the contents are saved with the memory channel list, set mode conditions, etc. at the same time.

See page 12-25 for details.

■ Memory channels	8-2
■ Memory channel selection	8-2
◇ Using the [▲]/[▼] keys	8-2
◇ Using the keypad	8-2
■ Memory list screen	8-3
◇ Selecting a memory channel using the memory list screen	8-3
◇ Confirming programmed memory channels	8-3
■ Memory channel programming	8-4
◇ Programming in VFO mode	8-4
◇ Programming in memory mode	8-4
■ Frequency transferring	8-5
◇ Transferring in VFO mode	8-5
◇ Transferring in memory mode	8-5
■ Memory names	8-6
◇ Editing (programming) memory names	8-6
■ Memory clearing	8-6
■ Memo pads	8-7
◇ Writing frequencies and operating modes into memo pads	8-7
◇ Calling up a frequency from a memo pad	8-7

Memory channels

The transceiver has 101 memory channels. Memory mode is very useful for quickly changing to often-used frequencies.

All 101 memory channels are tunable which means the programmed frequency can be tuned temporarily with the main dial, etc. in memory mode.

MEMORY CHANNEL	MEMORY CHANNEL NUMBER	CAPABILITY	TRANSFER TO VFO	OVER-WRITING	CLEAR
Regular memory channels	1-99	One frequency and one mode in each memory channel.	Yes	Yes	Yes
Scan edge memory channels	P1, P2	One frequency and one mode in each memory channel as scan edges for programmed scan.	Yes	Yes	No

Memory channel selection

Using the [▲]/[▼] keys

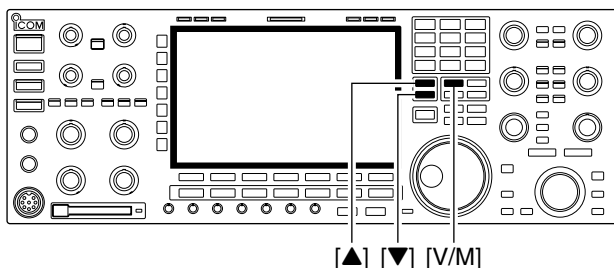

- ① Push [V/M] to select memory mode.
- ② Push [▲]/[▼] several times to select the desired memory channel.
 - Push and hold [▲]/[▼] for continuous selection.
 - [UP] and [DN] on the microphone can also be used.
- ③ To return to VFO mode, push [V/M] again.

Using the keypad

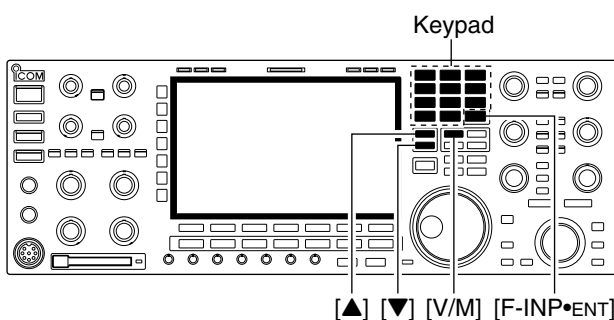

- ① Push [V/M] to select memory mode.
- ② Push [F-INP•ENT].
- ③ Push the desired memory channel number using the keypad.
 - Enter 100 or 101 to select scan edge channel P1 or P2, respectively.
- ④ Push [▲] or [▼] to select the desired memory channel.

[EXAMPLE]

- To select the memory channel 3;
 - Push [F-INP•ENT], [7•3], then push [▲] or [▼].
- To select the memory channel 12;
 - Push [F-INP•ENT], [1.8•1], [3.5•2], then push [▲] or [▼].
- To select the scan edge channel P1;
 - Push [F-INP•ENT], [1.8•1], [50•0], [50•0], then push [▲] or [▼].
- To select the scan edge channel P2;
 - Push [F-INP•ENT], [1.8•1], [50•0], [1.8•1], then push [▲] or [▼].

Memory list screen

The memory list screen simultaneously shows 9 memory channels and their programmed contents. 15 memory channels can be displayed in the wide memory list screen.

You can select a desired memory channel from memory list screen.

Selecting a memory channel using the memory list screen

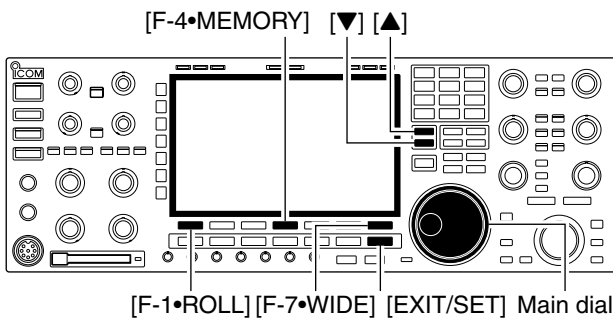

- ① Push [EXIT/SET] several times to close a multi-function screen, if necessary.
- ② Push [F-4•MEMORY] to select memory list screen.
 - [F-7•WIDE] switches the standard and wide screens.
- ③ While pushing [F-1•ROLL], rotate the main dial to select the desired memory channel.
 - [▲] and [▼] can also be used.
- ④ Push [EXIT/SET] to exit memory list screen.

Memory list screen

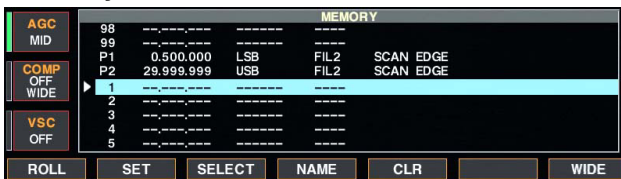

Confirming programmed memory channels

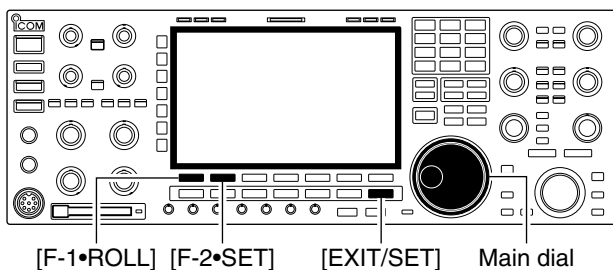

- ① Select memory list screen as described above.
- ② While pushing [F-1•ROLL], rotate the main dial to scroll the screen.
- ③ Push [F-2•SET] to select the highlighted memory channel, if desired.
 - “▶” appears beside the selected memory channel number in the memory list screen and the selected memory channel contents are displayed below the frequency readout.
- ④ Push [EXIT/SET] to exit memory list screen.

Memory channel programming

Memory channel programming can be performed either in VFO mode or in memory mode.

Programming in VFO mode

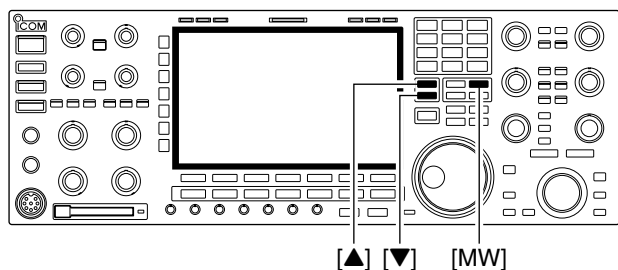

[EXAMPLE]: Programming 7.088 MHz/LSB into memory channel 12.

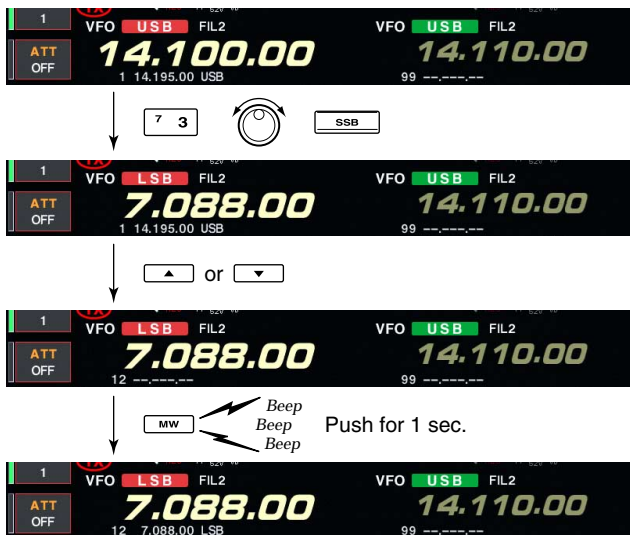

- ① Set the desired frequency, operating mode and filter width in VFO mode.
- ② Push [▲]/[▼] several times to select the desired memory channel.
 - Memory list screen is convenient for selecting the desired channel.
 - Memory channel contents appear in the memory channel readout (below the frequency readout).
 - “---.---.---” appears if the selected memory channel is a blank channel (and does not have contents).
- ③ Push [MW] for 1 sec. to program the displayed frequency, operating mode, etc., into the memory channel.

Programming in memory mode

[EXAMPLE]: Programming 21.280 MHz/USB into memory channel 18.



- ① Select the desired memory channel with [▲]/[▼] in memory mode.
 - Memory channel contents appear in the memory channel readout (below the frequency readout).
 - “---.---.---” appears if the selected memory channel is a blank channel (and does not have contents).
- ② Set the desired frequency and operating mode in memory mode.
 - To program a blank channel, use direct frequency entry with the keypad or memo pads, etc.
- ③ Push [MW] for 1 sec. to program the displayed frequency and operating mode into the memory channel.

Frequency transferring

Transferring in VFO mode

TRANSFERRING EXAMPLE IN VFO MODE
 Operating frequency : 21.320 MHz/USB (VFO)
 Contents of M-ch 16 : 14.018 MHz/CW

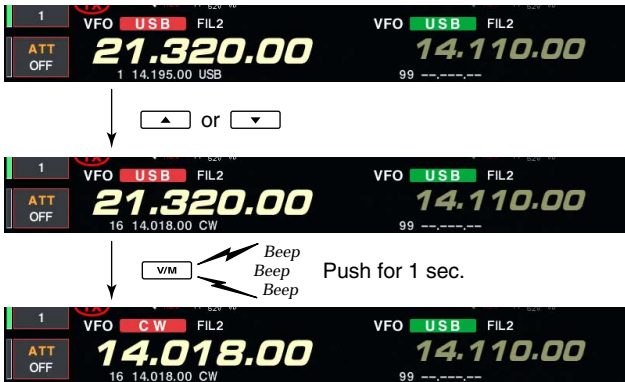

The frequency and operating mode in a memory channel can be transferred to the VFO. Frequency transferring can be performed in either VFO mode or memory mode.

This is useful for transferring programmed contents to VFO.

- ① Select VFO mode with [V/M].
- ② Select the memory channel to be transferred with [▲]/[▼].
 - Memory list screen is convenient for selecting the desired channel.
 - Memory channel contents appear in the memory channel readout (below the frequency readout).
 - “---.---.” appears if the selected memory channel is a blank channel. In this case transferring is impossible.
- ③ Push [V/M] for 1 sec. to transfer the frequency and operating mode.
 - Transferred frequency and operating mode appear on the frequency readout.

Transferring in memory mode

TRANSFERRING EXAMPLE IN MEMORY MODE
 Operating frequency : 21.320 MHz/USB (M-ch 16)
 Contents of M-ch 16 : 14.018 MHz/CW

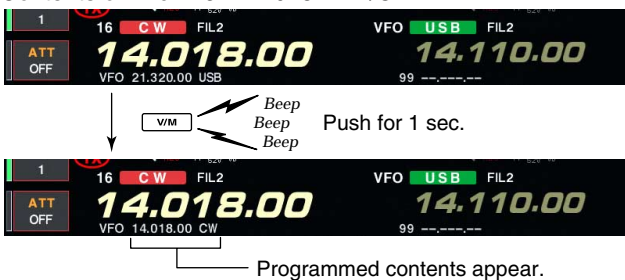

This is useful for transferring frequency and operating mode while operating in memory mode.

When you have changed the frequency or operating mode in the selected memory channel:

- **Displayed** frequency, mode and filter setting are transferred.
- **Programmed** frequency and mode in the memory channel are not transferred, and they remain in the memory channel.

- ① Select the memory channel to be transferred with [▲]/[▼] in memory mode.
 - And, set the frequency or operating mode if required.
- ② Push [V/M] for 1 sec. to transfer the frequency and operating mode.
 - Displayed frequency and operating mode are transferred to the VFO.
- ③ To return to VFO mode, push [V/M] momentarily.

Memory names

All memory channels (including scan edges) can be tagged with alphanumeric names of up to 10 characters each.

Capital letters, small letters, numerals, some symbols (! # \$ % & ¥ ? " ' ` ^ + - * / . , ; = < > () [] { } | _ ~ @) and spaces can be used.

Editing (programming) memory names

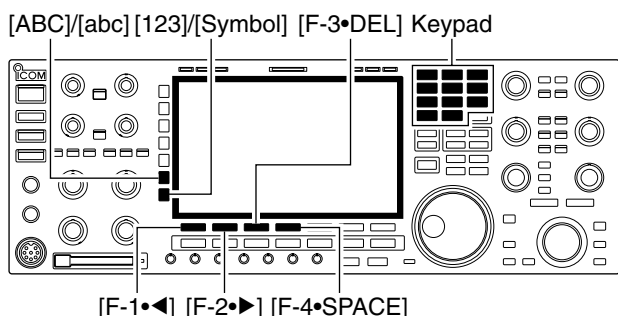

- ① Push [EXIT/SET] several times to close a multi-function screen, if necessary.
- ② Push [F-4•MEMORY] to select memory list screen.
- ③ Select the desired memory channel.
- ④ Push [F-4•NAME] to edit memory channel name.
 - A cursor appears and blinks.
 - Memory channel names of blank channels cannot be edited.
- ⑤ Input the desired character by rotating the main dial or by pushing the band key for number input.
 - Push [ABC] or [abc] to toggle capital and small letters.
 - Push [123] or [Symbol] to toggle numerals and symbols.
 - Push [F-1•◀] or [F-2•▶] for cursor movement.
 - Push [F-3•DEL] to delete the selected character.
 - Push [F-4•SPACE] to input a space.
 - Pushing the transceiver's keypad, [0]–[9], can also enter numerals.
- ⑥ Push [EXIT/SET] to input and set the name.
 - The cursor disappears.
- ⑦ Repeat steps ③ to ⑥ to program another memory channel's name, if desired.
- ⑧ Push [EXIT/SET] to exit memory list screen.

Memory clearing

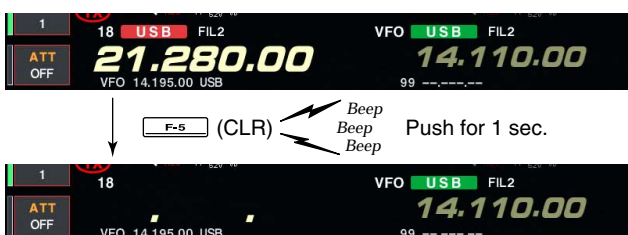
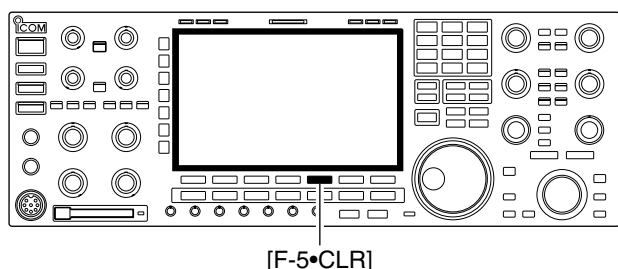

Any unnecessary memory channels can be cleared. The cleared memory channels become blank channels.

- ① Select memory mode with [V/M].
- ② Push [F-4•MEMORY] to select memory list screen.
- ③ Select the desired memory channel with [▲]/[▼].
- ④ Push [F-5•CLR] for 1 sec. to clear the contents.
 - The programmed frequency and operating mode disappear.
- ⑤ To clear other memory channels, repeat steps ③ and ④.

■ Memo pads

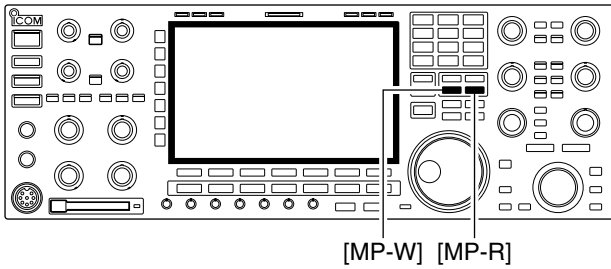

The transceiver has a memo pad function to store frequency and operating mode for easy write and recall. The memo pads are separate from memory channels.

The default number of memo pads is 5, however, this can be increased to 10 in set mode if desired. (p. 12-16)

Memo pads are convenient when you want to memorize a frequency and operating mode temporarily, such as when you find a DX station in a pile-up, or when a desired station is busy for a long time and you want to temporarily search for other stations.

Use the transceiver's memo pads instead of relying on hastily scribbled notes that are easily misplaced.

◇ Writing frequencies and operating modes into memo pads

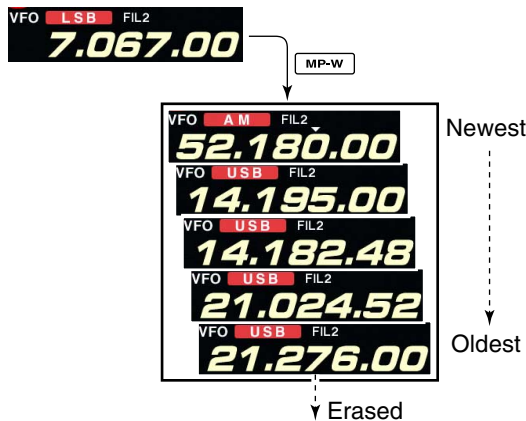

In this example, 21.276 MHz (LSB) will be erased when 7.067 MHz (LSB) is written.

You can simply write the accessed readout frequency and operating mode by pushing [MP-W].

When you write a 6th frequency and operating mode, the oldest written frequency and operating mode are automatically erased to make room for the new settings.

Each memo pad must have its own unique combination of frequency and operating mode; memo pads having identical settings cannot be written.

◇ Calling up a frequency from a memo pad

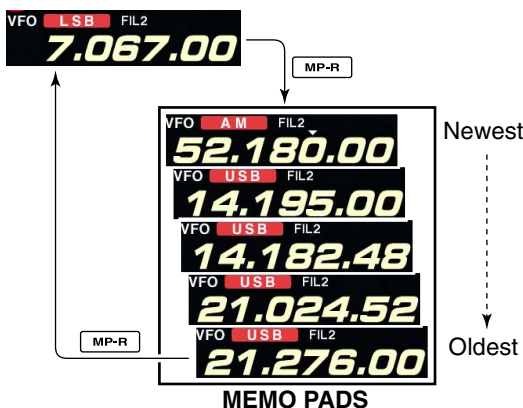

You can simply call up the desired frequency and operating mode of a memo pad by pushing [MP-R] several times.

- Both VFO and memory modes can be used.
- The frequency and operating mode are called up, starting from the most recently written.

When you call up a frequency and an operating mode from memo pads with [MP-R], the previously displayed frequency and operating mode are automatically stored in a temporary pad. The frequency and operating mode in the temporary pad can be recalled by pushing [MP-R] several times.

- You may think there are 6 memo pads because 6 different frequencies (5 are in memo pads and 1 is in the temporary pad) are called up by [MP-R].

If you change the frequency or operating mode called up from a memo pad with the main dial, etc., the frequency and operating mode in the temporary pad are erased.

■ Scan types	9-2
■ Preparation	9-2
■ Voice squelch control function	9-3
■ Scan set mode	9-3
■ Programmed scan operation	9-4
■ Δ F scan operation	9-4
■ Fine programmed scan/ Δ F scan	9-5
■ Memory scan operation	9-6
■ Select memory scan operation	9-6
■ Setting select memory channels	9-7
◇ Setting in scan screen	9-7
◇ Setting in memory list screen	9-7
◇ Erasing the select scan setting	9-7
■ Tone scan	9-8

Scan types

- The scan function can be used on the main read-out only.
- You can operate a scan while operating on a frequency using the dualwatch or split functions.

PROGRAMMED SCAN
Repeatedly scans between two scan edge frequencies (scan edge memory channels P1 and P2).

This scan operates in VFO mode.

ΔF SCAN
Repeatedly scans within ΔF span area.

This scan operates in both VFO and memory modes.

MEMORY SCAN
Repeatedly scans all programmed memory channels.

This scan operates in memory mode.

SELECT MEMORY SCAN
Repeatedly scans all or one of 3 select memory channels.

This scan operates in memory mode.

Preparation

Channels

For programmed scan:

Program scan edge frequencies into scan edge memory channels P1 and P2.

For ΔF scan:

Set the ΔF span (ΔF scan range) in the scan screen.

For memory scan:

Program 2 or more memory channels except scan edge memory channels.

For select memory scan:

Designate 2 or more memory channels as select memory channels. To designate the channel as a select memory channel, choose a memory channel, then push [F-3•SELECT] in the scan screen (memory mode) or in the memory list screen.

Scan resume ON/OFF

You can select the scan to resume or cancel when detecting a signal, in set mode. Scan resume ON/OFF must be set before operating a scan. See p. 9-3 for ON/OFF setting and scan resume condition details.

Scan speed

Scan speed can be selected from 2 levels, high or low, in scan set mode. See p. 9-3 for details.

Squelch condition

SCAN STARTS WITH	PROGRAMMED SCAN	MEMORY SCAN
SQUELCH OPEN	The scan continues until it is stopped manually, and does not pause even if it detects signals.	Scan pauses on each channel when the scan resume is ON; not applicable when OFF.
SQUELCH CLOSED	Scan stops when detecting a signal. If you set scan resume ON in set mode, the scan pauses for 10 sec. when detecting a signal, then resumes. When a signal disappears while scan is paused, scan resumes 2 sec. later.	

■ Voice squelch control function

This function is useful when you don't want unmodulated signals pausing or cancelling a scan. When the voice squelch control function is activated, the receiver checks received signals for voice components.

If a receiver signal includes voice components, and the tone of the voice components changes within 1 sec., scan pauses (or stops). If the received signal includes no voice components or the tone of the voice components does not change within 1 sec., scan resumes.

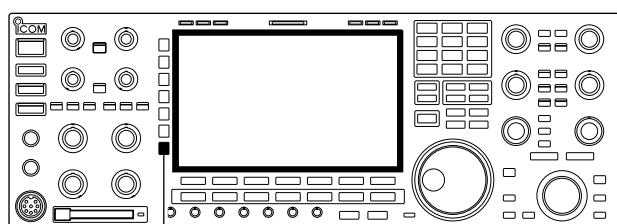

[VSC]

- ➔ While a phone mode (SSB, AM or FM) is selected, push [VSC] to switch the VSC (Voice Squelch Control) function ON and OFF.
 - "VSC" appears when the function is activated.

- ▨ • The VSC function activates for any scan.
- ▨ • The VSC function resumes the scan on unmodulated signals, regardless of whether the scan resume condition is set to ON or OFF.

■ Scan set mode

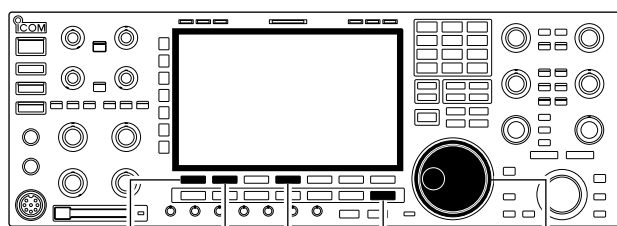

[F-1•▲] [F-2•▼] [F-4•DEF] [EXIT/SET] Main dial

When the squelch is open, scan continues until it is stopped manually—it does not pause on detected signals. When squelch is closed, scan stops when detecting a signal, then resumes according to the scan resume condition. Scan speed and the scan resume condition can be set using the scan set mode.

- ① Push [F-5•SCAN] to select scan screen.
- ② Push [F-7•SET] to select scan set mode.
- ③ Push [F-1•▲] or [F-2•▼] to select the desired item.
- ④ Rotate the main dial to select the desired condition.
 - Push [F-4•DEF] for 1 sec. to select the default setting.
- ⑤ Push [EXIT/SET] to return to scan menu.

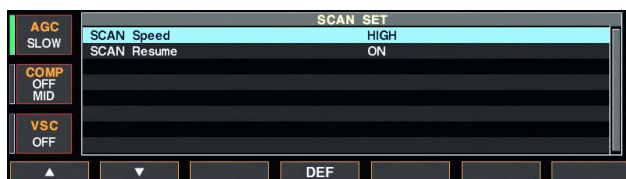

SCAN Speed	HIGH
Select the desired scan speed from high and low.	<ul style="list-style-type: none"> • HIGH : scan is faster • LOW : scan is slower

SCAN Resume	ON
Set the scan resume function ON and OFF.	<ul style="list-style-type: none"> • ON : When detecting a signal, scan pauses for 10 sec., then resumes. When a signal disappears, scan resumes 2 sec. later. • OFF : When detecting a signal, cancels scanning.

Programmed scan operation

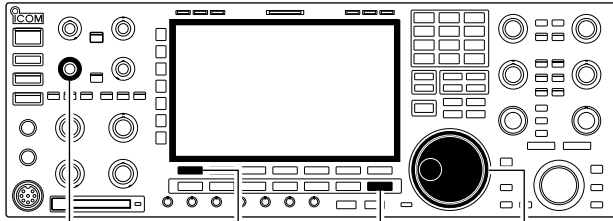

[SQL] for main [F-1•PROG] [EXIT/SET] Main dial

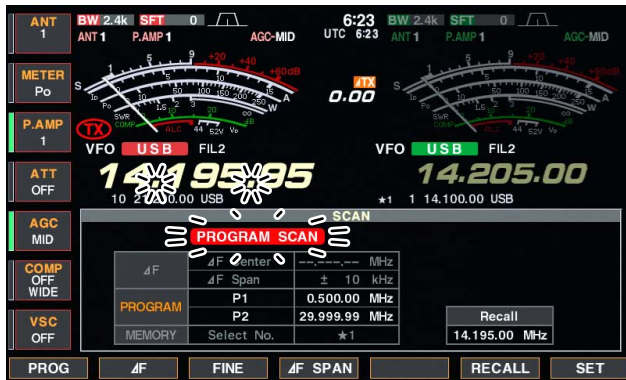

- ① Push [EXIT/SET] several times to close a multi-function screen, if necessary.
- ② Select VFO mode.
- ③ Select the desired operating mode.
 - The operating mode can also be changed while scanning.
- ④ Push [F-5•SCAN] to select the scan screen.
- ⑤ Set the main band's [SQL] open or closed.
 - See page 9-2 for squelch condition.
- ⑥ Push [F-1•PROG] to start the programmed scan.
 - "PROGRAM SCAN" and decimal points blink while scanning.
- ⑦ When the scan detects a signal, the scan stops, pauses or ignores it depending on the resume setting and the squelch condition.
- ⑧ To cancel the scan, push [F-1•PROG].
 - Rotating the main dial also cancels the scan.
- ⑨ Push [F-6•RECALL] for 1 sec. to recall the frequency that is set before starting the scan, if desired.

⚡ If the same frequencies are programmed into the scan edge memory channel P1 and P2, programmed scan does not start.

ΔF scan operation

[F-4• ΔF SPAN]

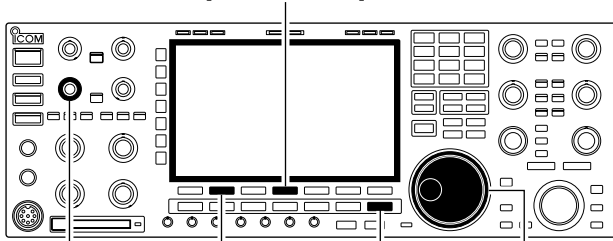

[SQL] for main [F-2• ΔF] [EXIT/SET] Main dial

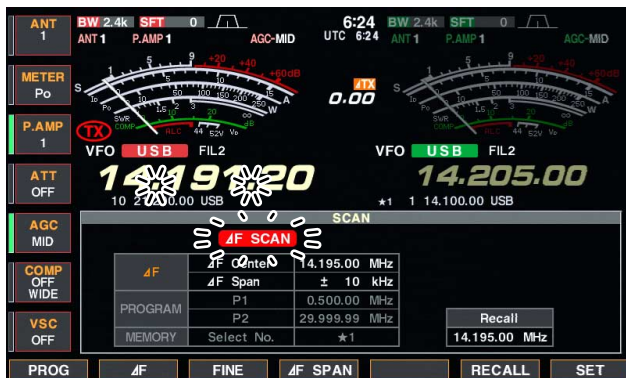

- ① Push [EXIT/SET] several times to close a multi-function screen, if necessary.
- ② Select VFO mode or a memory channel.
- ③ Select the desired operating mode.
 - The operating mode can also be changed while scanning.
- ④ Push [F-5•SCAN] to select the scan screen.
- ⑤ Set the main band's [SQL] open or closed.
 - See page 9-2 for squelch condition.
- ⑥ Set the ΔF span by pushing [F-4• ΔF SPAN].
 - ± 5 kHz, ± 10 kHz, ± 20 kHz, ± 50 kHz, ± 100 kHz, ± 500 kHz and ± 1000 kHz are selectable.
- ⑦ Set center frequency of the ΔF span.
- ⑧ Push [F-2• ΔF] to start the ΔF scan.
 - " ΔF SCAN" and decimal points blink while scanning.
- ⑨ When the scan detects a signal, the scan stops, pauses or ignores it depending on the resume setting and the squelch condition.
- ⑩ To cancel the scan, push [F-2• ΔF].
 - Rotating the main dial also cancels the scan.
- ⑪ Push [F-6•RECALL] for 1 sec. to recall the frequency that is set before starting the scan, if desired.

■ Fine programmed scan/fine ΔF scan

In fine scan (programmed or ΔF), the scan speed decreases when the squelch opens, but the transceiver keeps scanning. The scanning tuning step shifts from 50 Hz to 10 Hz when the squelch opens.

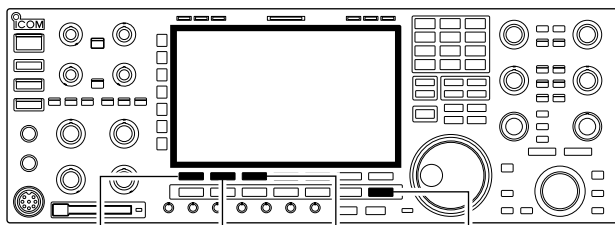

[F-1•PROG] [F-2• ΔF] [F-3•FINE] [EXIT/SET]



- ① Push [EXIT/SET] several times to close a multi-function screen, if necessary.
- ② Push [F-5•SCAN] to select the scan screen.
- ③ Set for programmed scan or ΔF scan as described on previous page.
- ④ Push [F-1•PROG] or [F-2• ΔF] to start a scan.
 - “PROGRAM SCAN” or “ ΔF SCAN” and decimal points blink while scanning.
- ⑤ Push [F-3•FINE] to start a fine scan.
 - “FINE PROGRAM SCAN” or “FINE ΔF SCAN” blinks instead of “PROGRAM SCAN” or “ ΔF SCAN,” respectively.
- ⑥ When the scan detects a signal, the scan speed decreases but scan does not stop.
- ⑦ Push [F-1•PROG] or [F-2• ΔF] to stop the scan; push [F-3•FINE] to cancel the fine scan.
 - Rotating the main dial also cancels the scan.
- ⑧ Push [F-6•RECALL] for 1 sec. to recall the frequency that is set before starting the scan, if desired.

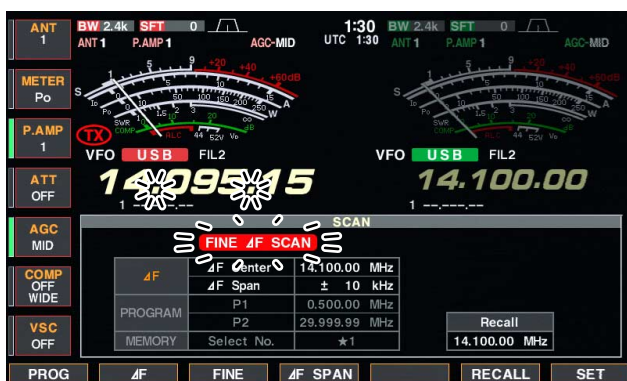

Memory scan operation

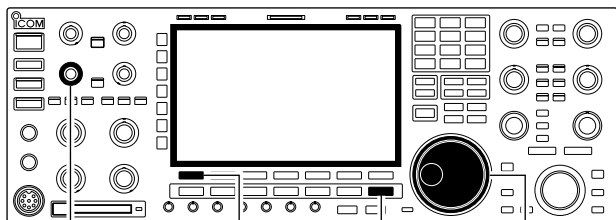

[SQL] for main [F-1•MEMO] [EXIT/SET] Main dial

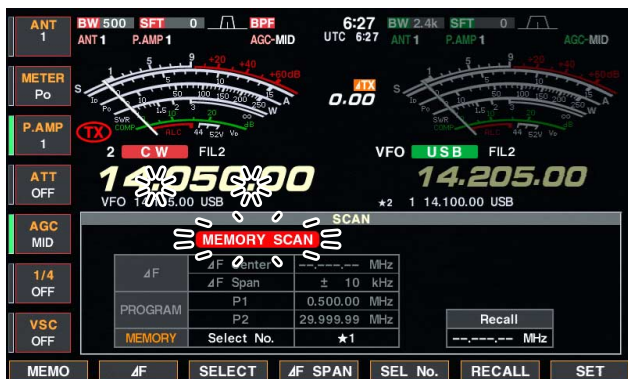

- ① Push [EXIT/SET] several times to close a multi-function screen, if necessary.
- ② Select memory mode.
- ③ Push [F-5•SCAN] to select the scan screen.
- ④ Set the main band's [SQL] open or closed.
 - See page 9-2 for squelch condition.
- ⑤ Push [F-1•MEMO] to start the memory scan.
 - "MEMORY SCAN" and decimal points blink while scanning.
- ⑥ When the scan detects a signal, the scan stops, pauses or ignores it depending on the resume setting and the squelch condition.
- ⑦ To cancel the scan, push [F-1•MEMO].
 - Rotating the main dial also cancels the scan.

2 or more memory channels must be programmed for memory scan to start.

Select memory scan operation

[F-3•SELECT] [F-5•SEL No.]

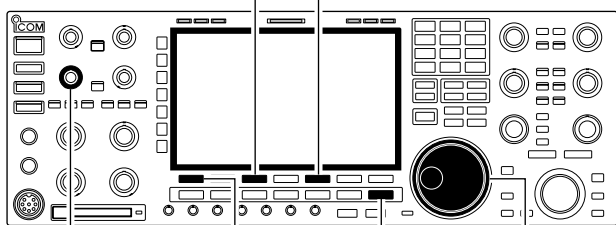

[SQL] for main [F-1•MEMO] [EXIT/SET] Main dial

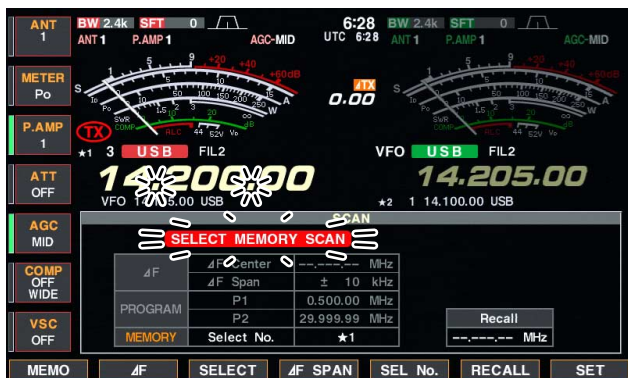

- ① Push [EXIT/SET] several times to close a multi-function screen, if necessary.
- ② Select memory mode.
- ③ Push [F-5•SCAN] to select the scan screen.
- ④ Set the main band's [SQL] open or closed.
 - See page 9-2 for squelch condition.
- ⑤ Push [F-5•SEL No.] several times to select the select scan number from ★1, ★2, ★3 and ★1/★2/★3.
- ⑥ Push [F-1•MEMO] to start the memory scan.
 - "MEMORY SCAN" and decimal points blink while scanning.
- ⑦ Push [F-3•SELECT] to start select memory scan; push [F-3•SELECT] again to return to memory scan, if desired.
 - "SELECT MEMORY SCAN" blinks instead of "MEMORY SCAN" during select memory scan.
- ⑧ When the scan detects a signal, the scan stops, pauses or ignores it depending on the resume setting and the squelch condition.
- ⑨ To cancel the scan, push [F-1•MEMO].
 - Rotating the main dial also cancels the scan.

2 or more memory channels must be designated as select memory channels, as well as the same select scan number, for select memory scan to start.

■ Setting select memory channels

◇ Setting in scan screen



- ① Push [EXIT/SET] several times to close a multi-function screen, if necessary.
- ② Select memory mode.
- ③ Push [F-5•SCAN] to select the scan screen.
- ④ Select the desired memory channel to set as a select memory channel.
 - [▲]/[▼] keys and direct keypad selections can be used.
- ⑤ Push [F-3•SELECT] several times to set the memory channel as a select memory ★1, ★2, ★3 or not.
- ⑥ Repeat steps ④ to ⑤ to program another memory channel as a select memory channel, if desired.
- ⑦ Push [EXIT/SET] to exit the scan screen.

◇ Setting in memory list screen



- ① Push [EXIT/SET] several times to close a multi-function screen, if necessary.
- ② Push [F-4•MEMORY] to select memory list screen.
- ③ Rotate the main dial while pushing [F-1•ROLL] or [F-2•SET] to select the desired memory channel.
 - [▲]/[▼] keys and direct keypad selections can be used.
- ④ Push [F-3•SELECT] several times to set the memory channel as a select memory ★1, ★2, ★3 or not.
- ⑤ Repeat steps ③ to ④ to program another memory channel as a select memory channel, if desired.
- ⑥ Push [EXIT/SET] to exit the memory list screen.

◇ Erasing the select scan setting



- ① Push [EXIT/SET] several times to close a multi-function screen, if necessary.
- ② Push [F-4•MEMORY] to select memory list screen, or push [F-5•SCAN] to select scan screen.
- ③ Push [F-3•SELECT] for 1 sec. to display memory select all clear window.
- ④ Push one of the following keys to clear all select scan setting.
 - [F-1•★1] : Clears all ★1 setting.
 - [F-2•★2] : Clears all ★2 setting.
 - [F-3•★3] : Clears all ★3 setting.
 - [F-4•★1,2,3] : Clears all select setting.
- ⑤ Push [EXIT/SET] to exit the memory list screen.

■ Tone scan

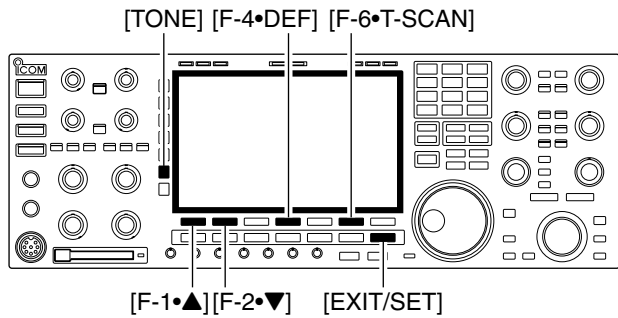

The transceiver can detect subaudible tones in a received signal. By monitoring a signal that is being transmitted on a repeater input frequency, you can determine the tone frequency required to access the repeater.

- ① Set the desired frequency or memory channel to be checked for a tone frequency.
- ② Push [AM/FM] several times to select FM mode.
- ③ Push [TONE] for 1 sec. to enter tone frequency screen.
- ④ Push [F-1•▲] or [F-2•▼] to check the repeater tone frequency or tone squelch frequency, respectively.
- ⑤ Push [F-6•T-SCAN] to start the tone scan.
 - "SCAN" blinks while scanning.
- ⑥ When the tone frequency is detected, the tone scan pauses.
 - The tone frequency is set temporarily on a memory channel. Program into the memory channel to store the tone frequency permanently.
 - The decoded tone frequency is used for the repeater tone frequency or tone squelch frequency.
- ⑦ To stop the scan, push [F-6•T-SCAN].
 - Push [F-4•DEF] for 1 sec. to select the default frequency.
- ⑧ Push [EXIT/SET] to exit tone frequency screen.

■ Antenna connection and selection	10-2
■ Antenna memory settings	10-3
◇ Antenna type selection	10-3
◇ Temporary memory	10-4
◇ Antenna selection mode	10-4
■ Antenna tuner operation	10-5
◇ Tuner operation	10-5
◇ If the tuner cannot tune the antenna	10-6

■ Antenna connection and selection

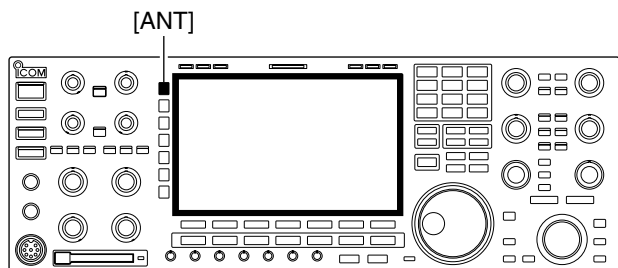

The IC-7800 has 4 antenna connectors for the HF/50 MHz bands, [ANT1], [ANT2], [ANT3], and [ANT4].

For each operating band the IC-7800 covers, there is a band memory which can memorize a selected antenna. When you change the operating frequency beyond a band, the previously used antenna is automatically selected (see below) for the new band. This function allows automatic switching of 4 separate antennas for HF and 50 MHz bands operation.

• Antenna selection mode: “Auto”

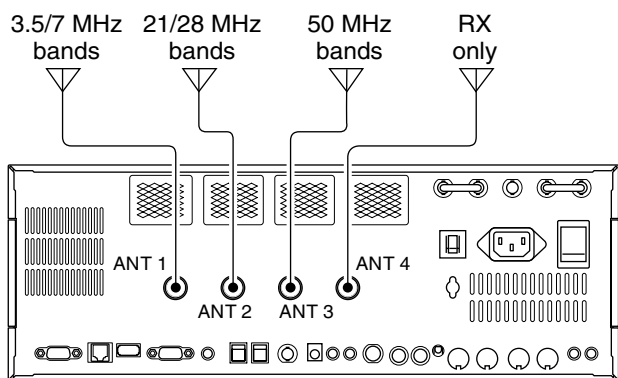

After an antenna has been selected for use (by pushing [ANT]), the antenna is automatically selected whenever that band is used.

[EXAMPLE]: a 3.5/7 MHz antenna is connected to [ANT1], a 21/28 MHz antenna is connected to [ANT2], a 50 MHz antenna is connected to [ANT3]. When the antenna selector function is set to “Auto,” an antenna is automatically selected when changing bands. [ANT4] can be used for receive only.

• Antenna selection mode: “Manual”

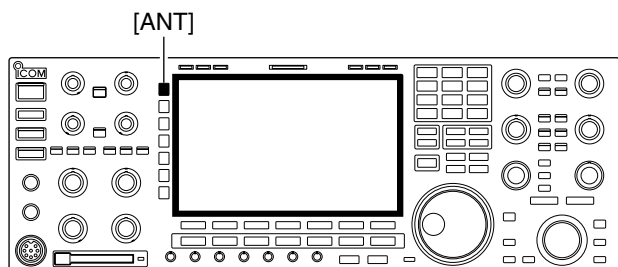

When “Manual” is selected, you can use the all antenna connectors, [ANT1] [ANT2], [ANT3] and [ANT4], however, band memory does not function. In this case you must select an antenna manually.

• Antenna selection mode: “OFF”

In this case, only [ANT1] antenna connector can be used. [ANT] switch does not function.

■ Antenna memory settings

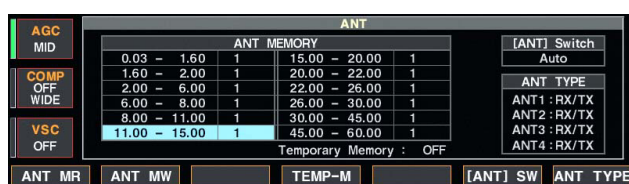
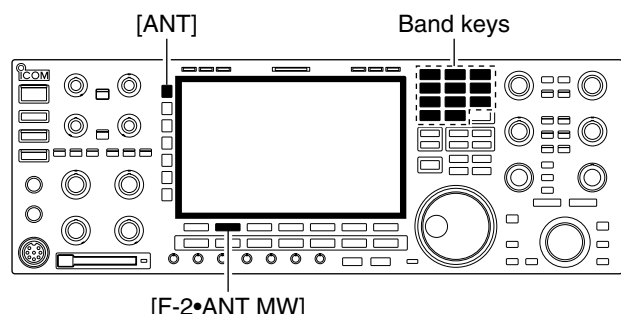

This function stores the antenna connector number for each frequency band.

- ① Push [EXIT/SET] several times to close multi-function screen, if necessary.
- ② Push [ANT] for 1 sec. to select antenna set screen.
- ③ Select the desired frequency band with a band key.
- ④ Push [ANT] several times to select the desired antenna number that you want to set for the selected frequency band.
 - “★” appears.
- ⑤ Push [F-2•ANT MW] for 1 sec. to store the antenna selection into the antenna memory.
 - “★” disappears.
- ⑥ Repeat the steps ③ to ⑤ to store the antenna selection for another frequency bands, if desired.
- ⑦ Push [EXIT/SET] to exit antenna set screen.

◇ Antenna type selection



When no antenna is connected to [ANT2], [ANT3], and/or [ANT4], these antenna connectors can be deactivated— deleting the antenna number from selection. This prevent the transceiver from accidentally transmitting into an empty antenna connector. In addition, a receive-only antenna can be specified for [ANT4].

- ① Select the antenna set screen as described above.
- ② Push [F-7•ANT TYPE] to select antenna type set screen.
- ③ Push [F-1•▲] or [F-2•▼] to select the desired antenna.
- ④ Rotate the main dial to select the desired antenna condition from TX/RX, RX (ANT4 only) and OFF.
 - TX/RX : Select when an antenna is connected.
 - OFF : Select when no antenna is connected.
 - RX : Select when a receive only antenna is connected. (available for the [ANT4] only)
- ⑤ Push [EXIT/SET] to exit antenna type set screen.

✓ For your information

The “OFF” antennas cannot be selected with [ANT] switch operation, or with the antenna memory setting. When “RX” is selected for [ANT4], “1/R,” “2/R” and “3/R” selections will be added for the selection for both [ANT] switch operation and the antenna memory setting. In these selections, using the antenna connected to [ANT1], [ANT2] and/or [ANT3] for transmission and using the antenna connected to [ANT4] for reception.

■ Antenna memory settings (continued)

◇ Temporary memory

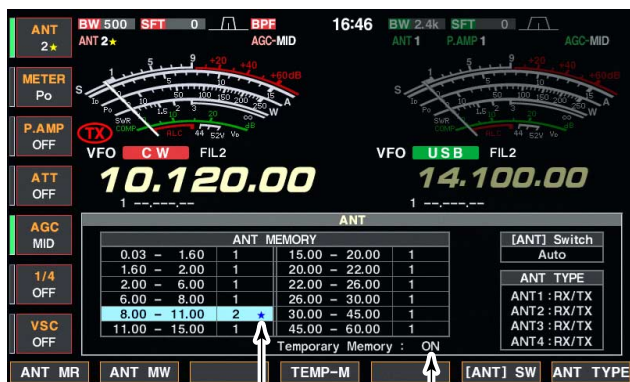

“★” appears when a different antenna from the original is selected.

Push [F-4]•TEMP-M to turn the temporary memory ON and OFF.

◇ Antenna selection mode

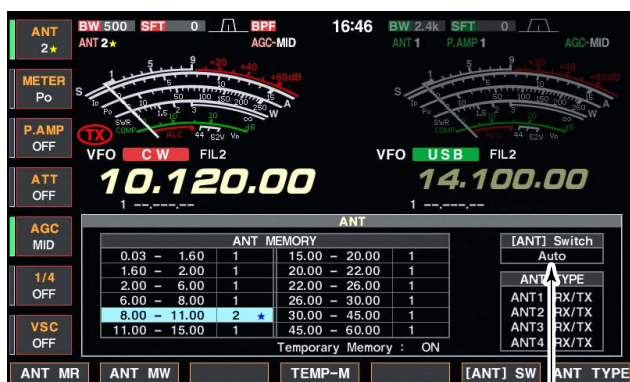

Push [F-6]•[ANT] SW to select the antenna selection mode.

The antenna temporary memory memorizes the manually selected antenna. The selected antenna will be re-called even if frequency band has been changed.

- ① Select the antenna set screen.
- ② Push [F-4]•TEMP-M to turn the temporary memory ON and OFF.
- ③ Select the desired frequency band with a band key.
- ④ Push [ANT] to select the desired antenna.
 - “★” appears when a different antenna from the original is selected.
- ⑤ Push [F-1]•ANT MR] to re-call the original antenna.
 - “★” disappears.
- ⑥ Push [EXIT/SET] to exit antenna set screen.

CAUTION! Before transmitting with the manually selected antenna, make sure the selected antenna suits the operating frequency. Otherwise the transceiver may be damaged.

The automatic antenna selection (antenna memory) and the [ANT] switch function can be deactivated if desired.

- ① Select the antenna set screen.
- ② Push [F-6]•[ANT] SW to select the antenna selection from Auto, OFF and Manual.
 - Auto : Use the antenna memory. Antenna selection with [ANT] switch is also available.
 - OFF : Only the antenna connected to [ANT1] can be used. [ANT] switch is deactivated.
 - Manual : Deactivate the antenna memory function. Antenna can be selected with [ANT] switch operation only.
- ③ Push [EXIT/SET] to exit antenna set screen.

■ Antenna tuner operation

The internal automatic antenna tuner matches the transceiver to the connected antenna automatically. After the tuner matches an antenna, the variable capacitor angles are memorized as a preset point for each frequency range (100 kHz steps). Therefore, when you change the frequency range, the variable capacitors are automatically preset to the memorized point.

CAUTION: NEVER transmit with the tuner ON when no antenna is connected. This will damage the transceiver. Be careful of the antenna selection.

◇ Tuner operation

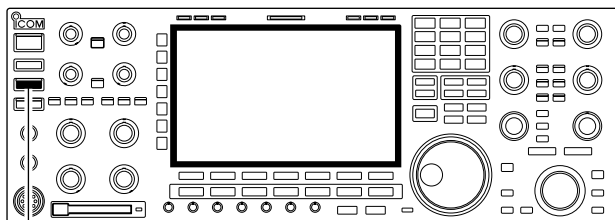

[TUNER]

- ➔ Push [TUNER] to turn the internal antenna tuner ON. The antenna is tuned automatically when the antenna SWR is higher than 1.5:1.
 - When the tuner is ON, [TUNER] switch indicator lights green.
 - While tuning, [TUNER] switch indicator blinks green.

NOTES:

- NEVER transmit without an antenna properly connected to antenna port in use.
- When 2 or more antennas are connected, select the antenna to be used with [ANT].
- If the SWR is higher than about 1.5:1 when tuning above 100 kHz on an antenna's preset point, push [TUNER] for 1 sec. to start manual tuning.
- The internal tuner may not be able to tune in AM mode. In such cases, push [TUNER] for 1 sec. to manually tune.

• MANUAL TUNING

During SSB operation at low voice levels, the internal tuner may not be tuned correctly. In such cases, manual tuning is helpful.

- ➔ Push [TUNER] for 1 sec., to start manual tuning.
 - A side tone is emitted and [TUNER] switch indicator blinks red while tuning.
 - If the tuner cannot reduce the SWR to less than 1.5:1 after 20 sec. of tuning, the [TUNER] switch indicator goes out.

• AUTOMATIC TUNER START (HF bands only)

If you want to deactivate the tuner under conditions of VSWR 1.5:1 or less, use the auto tuner start function and turn the tuner OFF. This function activates the tuner automatically when the SWR exceeds 1.5:1.

This function is turned ON in set mode. (p. 12-15).

■ Antenna tuner operation (continued)

• PTT TUNER START

The tuner is always tuned when the PTT is pushed after the frequency is changed (more than 1% from last-tuned frequency). This function removes the “push and hold [TUNER]” operation and activates for the first transmission on a new frequency.

This function is turned ON in set mode. (p. 12-15).

• Antenna tuner of the IC-PW1

When using an external antenna tuner such as the IC-PW1's tuner, tune with the external antenna tuner, and turn OFF the IC-7800's tuner. After tuning is completed, turn the internal tuner ON. Otherwise, both tuners tune simultaneously and correct tuning may not be obtained.

See the instruction manual included with each antenna tuner for their respective operations.

◇ If the tuner cannot tune the antenna

Check the following and try again:

- the [ANT] connector selection.
- the antenna connection and feedline.
- the untuned antenna SWR. (Less than 3:1 for HF bands; Less than 2.5:1 for 50 MHz band)
- the transmit power. (8 W for HF bands; 15 W for 50 MHz band)
- the power source voltage/capacity.

If the tuner cannot reduce the SWR to less than 1.5:1 after checking the above, perform the following:

- repeat manual tuning several times.
- tune with a 50 Ω dummy load and re-tune the antenna.
- turn power OFF and ON.
- adjust the antenna feedline length.
(This is effective for higher frequencies in some cases.)
- Some antennas, especially for low bands, have a narrow bandwidth. These antennas may not be tuned at the edge of their bandwidth, therefore, tune such an antenna as follows:

[Example]: Suppose you have an antenna which has an SWR of 1.5:1 at 3.55 MHz and an SWR of 3:1 at 3.8 MHz.

- ① Push [TUNER] to turn the antenna tuner ON.
- ② Select CW mode.
- ③ Turn OFF the break-in function. (p. 6-3)
- ④ Push [TRANSMIT] to set to the transmit condition.
- ⑤ Set 3.55 MHz and key down.
- ⑥ Set 3.80 MHz and key down.
- ⑦ Push [TRANSMIT] to return to the receive condition.

■ Time set mode	11-2
■ Daily timer setting	11-3
■ Setting sleep timer	11-4
■ Timer operation	11-4

Time set mode

[ABC]/[abc] [123]/[Symbol] [F-3◀▶] [F-5•EDIT]/[F-5•SET]

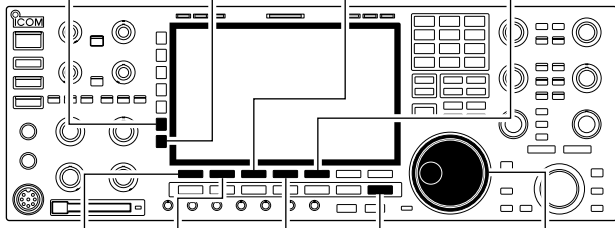

[F-1▲] [F-2▼] [F-4•DEF] [EXIT/SET] Main dial

The IC-7800 has a built-in calendar and 24-hour clock with daily power ON/OFF timer functions. Before operating these timer functions, set the current date and time.

- ① Push [EXIT/SET] to close multi-function screen, if necessary.
- ② Push [F-7•SET] to select set mode menu screen.
- ③ Push [F-4•TIME] to select time set mode.
- ④ Push [F-1▲] or [F-2▼] to select the desired item.
- ⑤ Rotate the main dial to set or select the desired value or condition.
- ⑥ Push [EXIT/SET] to exit time set mode.

Date	2000 - 1 - 1 (Sat)
Sets the date.	<ol style="list-style-type: none"> ① Push [F-3◀▶] to select between the year and the month/day, then rotate the main dial to select them. <ul style="list-style-type: none"> • The date setting and "DATE-set Push [SET]" indication blink. ② Push [F-5•SET] to set the date.

Time (Now)	1:23
Sets the local time.	<ol style="list-style-type: none"> ① Rotate the main dial to set the local time. <ul style="list-style-type: none"> • The time setting and "TIME-set Push [SET]" indication blink. ② Push [F-5•SET] to set the time.

CLOCK2 Function	ON
Turns the clock 2 indication ON and OFF. The clock 2 is convenient to indicate the UTC or other country's local time, etc.	<ul style="list-style-type: none"> • ON : The clock 2 is displayed below the local time indication. • OFF : The clock 2 does not display.

CLOCK2 Offset	± 0:00
Sets the desired off-set time period for clock 2 display within -24:00 to +24:00 in 5 min. steps.	<ul style="list-style-type: none"> • Push [F-4•DEF] for 1 sec. to select the default value.

CLOCK2 Name	UTC
Sets the desired 3-character name for clock 2. Capital letters, small letters, numerals, some symbols (! # \$ % & ¥ ? " ' ` ^ + - * / . , ; = < > () [] { } _ ~ @) and spaces can be used.	<ol style="list-style-type: none"> ① Push [F-5•EDIT] to select the name edit condition. <ul style="list-style-type: none"> • The cursor under the 1st character blinks. ② Push [ABC], [abc], [123] or [Symbol] to select the character group, then rotate the main dial to select the character. <ul style="list-style-type: none"> • Push [ABC] or [abc] to toggle capital and small letters. • Push [123] or [Symbol] to toggle numerals and symbols. • Push [F-1◀] or [F-2▶] for cursor movement. • Push [F-3•DEL] to delete the selected character. • Push [F-4•SPACE] to input a space. • Pushing the transceiver's keypad, [0]–[9], can also enter numerals. ③ Push [EXIT/SET] to set the name.

■ Daily timer setting

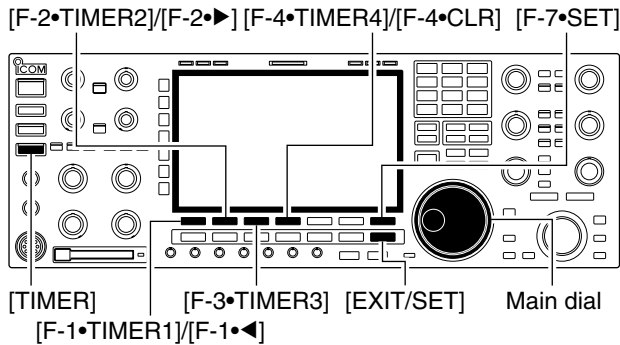

The transceiver turns power ON and/or OFF automatically on the specified day and time, with the specified frequency settings in each main and sub readout.

- ① Push [EXIT/SET] several times to close multi-function screen, if necessary.
- ② Push [TIMER] for 1 sec. to select timer set screen.
- ③ Push one of [F-1•TIMER1] to [F-5•TIMER5] to select the desired timer.
- ④ Rotate the main dial to select the timer action ON and OFF.
- ⑤ Push [F-2•▶] to select the "DAY" cell, then rotate the main dial to select the desired day of the week.
 - Select " - - - " not to specify the day of the week. The timer will function every day in this case.
 - Once a day of the week is selected, push [F-4•CLR] for 1 sec. to select " - - - ."
- ⑥ Push [F-2•▶] to select the "REPEAT" cell, then rotate the main dial to select the repeat function ON and OFF.
 - ON : The timer functions every selected day of the week. (repeats)
 - OFF : The timer does not repeat.
- ⑦ Push [F-2•▶] to select the "ON" cell, then rotate the main dial to set the desired transceiver power ON time.
 - When using power OFF timer only, push [F-4•CLR] for 1 sec. to select " - - - ."
- ⑧ Push [F-2•▶] to select the "OFF" cell, then rotate the main dial to set the desired transceiver power OFF time.
 - When using power ON timer only, push [F-4•CLR] for 1 sec. to select " - - - ."
- ⑨ Push [F-2•▶] to select the "MAIN" cell, then rotate the main dial to select the desired memory channel number in the main readout.
 - If using the currently set VFO condition in main readout, push [F-4•CLR] for 1 sec. to select " - - - ."
- ⑩ Push [F-2•▶] to select the "SUB" cell, then rotate the main dial to select the desired memory channel number in the sub readout.
 - If using the currently set VFO condition in sub readout, push [F-4•CLR] for 1 sec. to select " - - - ."
- ⑪ Push [F-7•SET] to set the timer.
 - The timer indicator above [TIMER] switch lights green.
- ⑫ Repeat steps ③ to ⑪ to set other timers, if desired.
- ⑬ Push [EXIT/SET] to exit timer set screen.

Setting sleep timer

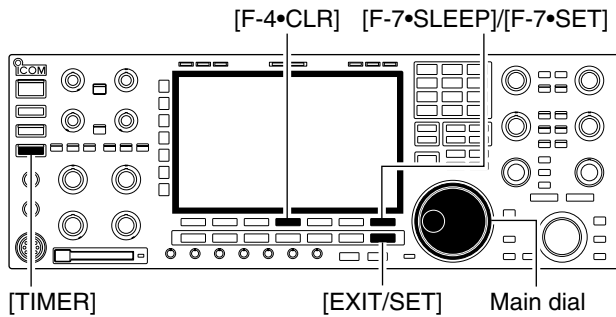

The sleep timer turns the transceiver power OFF automatically after passing the set period. The timer can be set to 5–120 min. in 5 min. steps.

- ① Push [EXIT/SET] several times to close a multi-function screen, if necessary.
- ② Push [TIMER] for 1 sec. to select timer set screen.
- ③ Push [F-7•SLEEP] to select the sleep timer set condition.
 - “---” blinks.
- ④ Set the desired time period using the main dial.
 - “TIMER-set Push [SET]” blinks.
 - Push [F-4•CLR] to select “---” to cancel the setting.
- ⑤ Push [F-7•SET] to set the time.
 - Push [EXIT/SET] to cancel the setting.
 - The timer indicator above [TIMER] switch lights green.
- ⑥ Push [EXIT/SET] to exit timer set screen.
- ⑦ The transceiver emits 10 beeps and turns OFF after the sleep timer period elapses.
 - The timer indicator blinks while beeping.
 - Push [TIMER] momentarily to cancel the sleep timer, if desired.

Timer operation

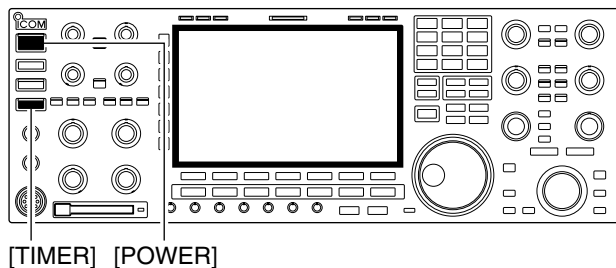

- ① Preset the daily timer as described previously.
- ② Push [TIMER] momentarily to turn the timer function ON.
 - The timer indicator above this switch lights green when the timer function is ON.
- ③ Push [POWER] for 1 sec. to turn the power OFF.
 - The timer indicator lights continuously.
- ④ When the set time arrives, the power is automatically turned ON.
- ⑤ The transceiver emits 10 beeps and turns OFF after the power-off period elapses.
 - The timer indicator blinks while beeping.
 - Push [TIMER] momentarily to cancel the sleep timer, if desired.

/// The timer action in timer set screen must be selected ON to enable the timer operation, described in page 11-3 steps ④.

■ Set mode description	12-2
◇ Set mode operation	12-2
◇ Screen arrangement	12-3
■ Level set mode	12-4
■ ACC set mode	12-6
■ Display set mode	12-11
■ Miscellaneous (Others) set mode	12-14
■ CF card set menu	12-22
◇ CF card set screen arrangement	12-22
◇ Save option set mode	12-23
◇ Load option set mode	12-24
■ File saving	12-25
■ File loading	12-26
■ Changing the file name	12-27
■ Deleting a file	12-28
■ Formatting the CF card	12-28

■ Set mode description

Set mode is used for programming infrequently changed values or conditions of functions. The IC-7800 has a level set mode, display set mode, timer set mode, accessory set mode, miscellaneous (others) set mode and CF card set mode.

◇ Set mode operation

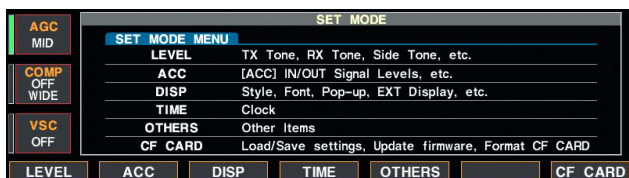
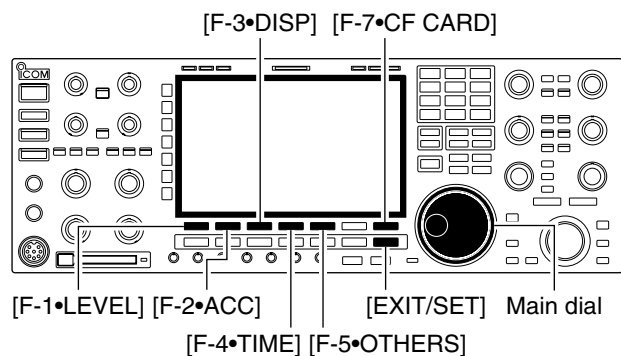

- ① Push [EXIT/SET] several times to close a multi-function screen, if necessary.
- ② Push [F-7•SET] to select set mode menu screen.
 - Pushing and holding [EXIT/SET] for 1 sec. also selects set mode menu screen.
- ③ Push [F-1•LEVEL], [F-2•ACC], [F-3•DISP], [F-4•TIME], [F-5•OTHERS] or [F-7•CF CARD] to enter the desired set mode.
- ④ For level, accessory, display and miscellaneous (others) set mode, push [F-7•WIDE] to toggle wide and normal screen.
- ⑤ Push [F-1•▲] or [F-2•▼] to select the desired item, then rotate main dial to adjust/select the desired value or condition.
 - Pushing [F-3•◀ ▶] operation may be necessary for some items.
- ⑥ Push [EXIT/SET] twice to exit set mode.

◇ Screen arrangement



• Display set mode (p. 12-11)



F-3

• Set mode menu screen (p. 12-2)

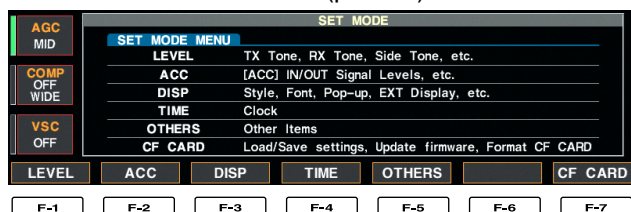

• Time set mode (p. 11-2)



F-4

• Level set mode (p. 12-4)



• Miscellaneous (Others) set mode (p. 12-14)

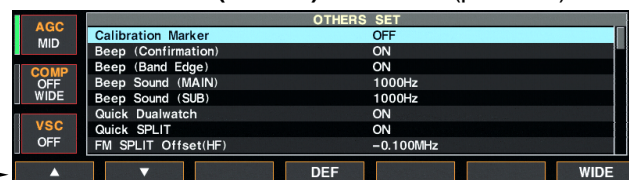

F-5

• ACC set mode (p. 12-6)

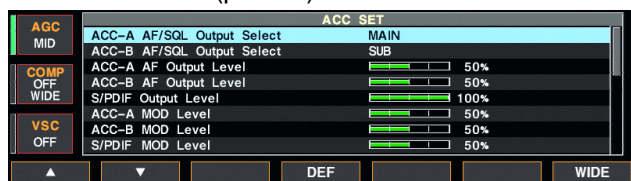

• CF card set menu (p. 12-22)

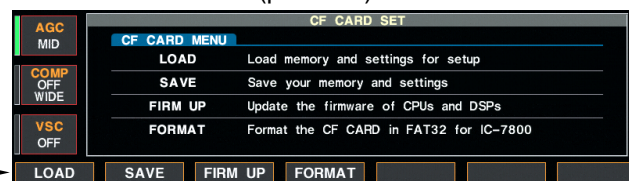

F-2

F-7

■ Level set mode

SSB TX Tone (Bass)  0

Sets the bass level of the transmit audio tone in SSB mode from -5 to +5. (default: 0)

SSB TX Tone (Treble)  0

Sets the treble level of the transmit audio tone in SSB mode from -5 to +5. (default: 0)

AM TX Tone (Bass)  0

Sets the bass level of the transmit audio tone in AM mode from -5 to +5. (default: 0)

AM TX Tone (Treble)  0

Sets the treble level of the transmit audio tone in AM mode from -5 to +5. (default: 0)

FM TX Tone (Bass)  0

Sets the bass level of the transmit audio tone in FM mode from -5 to +5. (default: 0)

FM TX Tone (Treble)  0

Sets the treble level of the transmit audio tone in FM mode from -5 to +5. (default: 0)

SSB RX Tone (Bass)  0

Sets the bass level of the receive audio tone in SSB mode from -5 to +5. (default: 0)

SSB RX Tone (Treble)  0

Sets the treble level of the receive audio tone in SSB mode from -5 to +5. (default: 0)

AM RX Tone (Bass)  0

Sets the bass level of the receive audio tone in AM mode from -5 to +5. (default: 0)

AM RX Tone (Treble)  0

Sets the treble level of the receive audio tone in AM mode from -5 to +5. (default: 0)

■ Level set mode (continued)

FM RX Tone (Bass)

0

Sets the bass level of the receive audio tone in FM mode from -5 to +5. (default: 0)

FM RX Tone (Treble)

0

Sets the treble level of the receive audio tone in FM mode from -5 to +5. (default: 0)

SSB TBW (WIDE)

100 - 2900

Sets the transmission passband width to wide setting by changing the lower and higher cut-off frequencies.

Lower freq. : 100 (default), 200, 300 and 500 Hz
Higher freq.: 2500, 2700, 2800 and 2900 Hz (default)

SSB TBW (MID)

300 - 2700

Sets the transmission passband width to middle setting by changing the lower and higher cut-off frequencies.

Lower freq. : 100, 200, 300 (default) and 500 Hz
Higher freq.: 2500, 2700 (default), 2800 and 2900 Hz

SSB TBW (NAR)

500 - 2500

Sets the transmission passband width to narrow setting by changing the lower and higher cut-off frequencies.

Lower freq. : 100, 200, 300 and 500 Hz (default)
Higher freq.: 2500 (default), 2700, 2800 and 2900 Hz

Speech Level

50%

Sets the voice synthesizer audio output level from 0 to 100% in 1% steps. (default: 50%)

Side Tone Level

50%

Sets the side tone output level from 0 to 100% in 1% steps. (default: 50%)

Side Tone Level Limit

ON

Turns the side tone output level limiting capability from ON and OFF. (default: ON)

Beep Level

50%

Sets the key-touch beep output level from 0 to 100% in 1% steps. (default: 50%)

Beep Level Limit

ON

Turns the key-touch beep output level limiting capability from ON and OFF. (default: ON)

■ Level set mode (continued)

Phones Level Ratio	 1.00
Sets the ratio for audio output level from the headphone toward to the internal speaker within 0.60 to 1.40 range in 0.01 steps. (default: 1.00)	

Phone L/R Mix	OFF
Selects the headphone audio output.	<ul style="list-style-type: none"> • OFF : Outputs the main band's audio from the left, and sub band's audio from the right. (default) • ON : Outputs the mixed audio.

■ ACC set mode

ACC-A AF/SQL Output Select	MAIN
Selects the desired band for the audio and squelch signals output from [ACC1-A] (Audio: pin 5, Squelch: pin 6) from MAIN and SUB.	<ul style="list-style-type: none"> • MAIN : Main band's AF and squelch signals are output from [ACC1-A]. (default) • SUB : Sub band's AF and squelch signals are output from [ACC1-A].

ACC-B AF/SQL Output Select	SUB
Selects the desired band for the audio and squelch signals output from [ACC1-B] (Audio: pin 5, Squelch: pin 6) from MAIN and SUB.	<ul style="list-style-type: none"> • MAIN : Main band's AF and squelch signals are output from [ACC1-B]. • SUB : Sub band's AF and squelch signals are output from [ACC1-B]. (default)

ACC-A AF Output Level	 50%
Sets the desired audio output level, output from [ACC1-A], within 0 to 100% in 1% steps.	<ul style="list-style-type: none"> • Outputs approx. 200 mV at 50% (default) setting.

ACC-B AF Output Level	 50%
Sets the desired audio output level, output from [ACC1-B], within 0 to 100% in 1% steps.	<ul style="list-style-type: none"> • Outputs approx. 200 mV at 50% (default) setting.

S/PDIF Output Level	 100%
Sets the desired output level of [S/P DIF], within 0 to 100% in 1% steps. (default: 100%)	

ACC-A MOD Level	 50%
Sets the desired audio input level for modulation from [ACC1-A].	<ul style="list-style-type: none"> • Approx. 100 mV at 50% (default) setting.

■ ACC set mode (continued)

ACC-B MOD Level



50%

Sets the desired audio input level for modulation from [ACC1-B].

- Approx. 100 mV at 50% (default) setting.

S/PDIF MOD Level



50%

Sets the desired input level for modulation from [S/P DIF], within 0 to 100% in 1% steps. (default: 50%)

DATA OFF MOD

MIC,ACC-A,ACC-B

Selects the desired connector(s) for modulation input when data mode is not in use.

- MIC : Use the signals from [MIC].
- ACC-A : Use the signals from [ACC1-A] (pin 4).
- ACC-B : Use the signals from [ACC1-B] (pin 4).
- MIC,ACC-A : Use the signals from [MIC] and [ACC1-A] (pin 4).
- MIC,ACC-B : Use the signals from [MIC] and [ACC1-B] (pin 4).
- ACC-A,ACC-B : Use the signals from [ACC1-A] and [ACC1-B] (pin 4).
- MIC,ACC-A,ACC-B : Use the signals from [MIC], [ACC1-A] and [ACC1-B] (pin 4). (default)
- S/P DIF : Use the signals from [S/P DIF].

DATA1 MOD

ACC-A

Selects the desired connector(s) for modulation input when data 1 mode (D1) is in use.

- MIC : Use the signals from [MIC].
- ACC-A : Use the signals from [ACC1-A] (pin 4). (default)
- ACC-B : Use the signals from [ACC1-B] (pin 4).
- MIC,ACC-A : Use the signals from [MIC] and [ACC1-A] (pin 4).
- MIC,ACC-B : Use the signals from [MIC] and [ACC1-B] (pin 4).
- ACC-A,ACC-B : Use the signals from [ACC1-A] and [ACC1-B] (pin 4).
- MIC,ACC-A,ACC-B : Use the signals from [MIC], [ACC1-A] and [ACC1-B] (pin 4).
- S/P DIF : Use the signals from [S/P DIF].

■ ACC set mode (continued)

DATA2 MOD	ACC-B
<p>Selects the desired connector(s) for modulation input when data 2 mode (D2) is in use.</p>	<ul style="list-style-type: none"> • MIC : Use the signals from [MIC]. • ACC-A : Use the signals from [ACC1-A] (pin 4). • ACC-B : Use the signals from [ACC1-B] (pin 4). (default) • MIC,ACC-A : Use the signals from [MIC] and [ACC1-A] (pin 4). • MIC,ACC-B : Use the signals from [MIC] and [ACC1-B] (pin 4). • ACC-A,ACC-B : Use the signals from [ACC1-A] and [ACC1-B] (pin 4). • MIC,ACC-A,ACC-B : Use the signals from [MIC], [ACC1-A] and [ACC1-B] (pin 4). • S/P DIF : Use the signals from [S/P DIF].

DATA3 MOD	ACC-A,ACC-B
<p>Selects the desired connector(s) for modulation input when data 3 mode (D3) is in use.</p>	<ul style="list-style-type: none"> • MIC : Use the signals from [MIC]. • ACC-A : Use the signals from [ACC1-A] (pin 4). • ACC-B : Use the signals from [ACC1-B] (pin 4). • MIC,ACC-A : Use the signals from [MIC] and [ACC1-A] (pin 4). • MIC,ACC-B : Use the signals from [MIC] and [ACC1-B] (pin 4). • ACC-A,ACC-B : Use the signals from [ACC1-A] and [ACC1-B] (pin 4). (default) • MIC,ACC-A,ACC-B : Use the signals from [MIC], [ACC1-A] and [ACC1-B] (pin 4). • S/P DIF : Use the signals from [S/P DIF].

ACC-A BAND Voltage Output	TX
<p>Selects the desired band for the operating frequency band control signal output from [ACC2-A] (pin 4).</p>	<ul style="list-style-type: none"> • MAIN : Outputs the band signal displayed in main readout. • SUB : Outputs the band signal displayed in sub readout. • TX : Outputs the band signal, that can be transmitted. (default)

ACC-B BAND Voltage Output	TX
<p>Selects the desired band for the operating frequency band control signal output from [ACC2-B] (pin 4).</p>	<ul style="list-style-type: none"> • MAIN : Outputs the band signal displayed in main readout. • SUB : Outputs the band signal displayed in sub readout. • TX : Outputs the band signal, that can be transmitted. (default)

■ ACC set mode (continued)

SEND Relay Type	Lead
<p>Selects the switching relay type for [RELAY] from Lead and MOS-FET. Select the suitable relay type when connecting a non-lcom linear amplifier.</p>	<ul style="list-style-type: none"> • Lead : Use mechanical relay. (16 V DC/0.5 A max.; default) • MOS-FET : Use semiconductor type relay. (250 V/200 mA max.)

External Meter Output (M)	Auto
<p>Selects the desired item for an external meter indication (main readout).</p>	<ul style="list-style-type: none"> • Auto : Outputs the receiving signal strength level during receive, and outputs the selected level (selected with [METER]), during transmit. (default) • S(MAIN) : Outputs the receiving signal strength level during receive. • Po : Outputs the transmitting power level during transmit. • SWR : Outputs the VSWR level during transmit. • ALC : Outputs the ALC level during transmit. • COMP : Outputs the compression level during transmit. • V_D : Outputs the drain terminal voltage of the final amplifier MOS-FETs. • I_D : Outputs the drain current of the final amplifier MOS-FETs.

External Meter Output (S)	Auto
<p>Selects the desired item for an external meter indication (sub readout).</p>	<ul style="list-style-type: none"> • Auto : Outputs the receiving signal strength level during receive, and outputs the selected level (selected with [METER]), during transmit. (default) • S(MAIN) : Outputs the receiving signal strength level during receive. • Po : Outputs the transmitting power level during transmit. • SWR : Outputs the VSWR level during transmit. • ALC : Outputs the ALC level during transmit. • COMP : Outputs the compression level during transmit. • V_D : Outputs the drain terminal voltage of the final amplifier MOS-FETs. • I_D : Outputs the drain current of the final amplifier MOS-FETs.

External Meter Level (M)	 50%
<p>Sets the output level for an external meter indication (main readout) with in 0 to 100% range in 1% steps.</p>	<ul style="list-style-type: none"> • Approx. 2.5 V at 50% (default) setting for full-scale indication. (4.7 kΩ impedance)

External Meter Level (S)	 50%
<p>Sets the output level for an external meter indication (sub readout) with in 0 to 100% range in 1% steps.</p>	<ul style="list-style-type: none"> • Approx. 2.5 V at 50% (default) setting for full-scale indication. (4.7 kΩ impedance)

■ ACC set mode (continued)

REF IN/OUT	OFF
Selects the transceiver's reference signal condition from IN, OFF and OUT.	<ul style="list-style-type: none">• IN : Use an external reference signal for the IC-7800.• OFF : Not input/output the reference signal. (default)• OUT : Outputs the IC-7800 reference signal to externally connected equipment(s) for their reference.
	<p>/// NOTE: If the applied reference signal is off-frequency, or no signal is applied with "IN" selection, the IC-7800 will not work properly. Select "OFF" or "OUT" then reboot the IC-7800 in such case.</p>

REF Adjust	 50%
Adjusts the internal reference signal frequency within 0 to 100% range in 1% steps during frequency calibration. (default: 50%)	

■ Display set mode

LCD Unit Bright



50%

Adjusts the LCD unit brightness from 0 (dark) to 100% (bright) range in 1% steps. (default: 50%)

Backlight (Switches)



80

Adjusts the switch indicators brightness from 1 (dark) to 100 (bright) range in 1 steps. (default: 80)

Display Type

A

Selects the desired display type from A, B and C. (default: A)

Display Font

Italic (1)

Selects the desired font for frequency readout from Italic (1), Italic (2), Italic (3), Italic (4), Round (1), Round (2), Round (3), Shadow (1), Shadow (2), Shadow (3), Qubic (1), Qubic (2), Qubic (3), Qubic (4), IC-780 (1), IC-780 (2), IC-780 (3) and IC-780 (4). (default: Italic (1))

Text Font

Normal

Selects the desired font for the displays other than frequency readout from Normal and Slim. (default: Normal)

Meter Response

MID

Set meter needle response from SLOW, MID and FAST. (default: MID)

This setting is effective for the standard and edge-wise meter type selections only.

Meter Type (Normal Screen)

Standard

Selects the desired S/RF meter type during normal screen indication from Standard, Edgewise and Bar. (default: Standard)

Meter Type (Wide Screen)

Edgewise

Selects the desired S/RF meter type during wide screen or mini scope indication from Edgewise and Bar. (default: Edgewise)

Meter Peak Hold (Bar)

ON

Turns the meter peak hold function ON and OFF. (default: ON)
This function is used for the bar meter only.

■ Display set mode (continued)

<p>Memory Name</p> <p>Sets the memory name indication, during memory mode operation, ON and OFF. (default: ON)</p>	<p>ON</p> <ul style="list-style-type: none"> • ON : The programmed memory name is displayed above the frequency indication. • OFF : No memory name is displayed even a memory name is programmed.
<p>APF-Width Popup (APF OFF→ON)</p> <p>Selects the pop-up display for the APF filter width from ON and OFF. (default: ON)</p>	<p>ON</p>
<p>MN-Q Popup (MN OFF→ON)</p> <p>Turns the pop-up indication capability when the notch filter width is changed from ON to OFF. (default: ON)</p>	<p>ON</p>
<p>Screen Saver Function</p> <p>Turns the screen saver function ON (15, 30 or 60 minutes) and OFF. (default: 60 min.)</p>	<p>60min</p> <p>The screen saver will acts when no operation is performed for the selected time period to protect the LCD from the “burn-in” effect.</p>
<p>Screen Saver Type</p> <p>Selects the screen saver type from “Bound,” “Rotation” and “Twist.” (default: Bound)</p>	<p>Bound</p> <p>The screen saver indication can be displayed for your reference while pushing and holding [F-5•PREVIEW].</p>
<p>External Display</p> <p>Select “ON” when the external display is connected. (default: OFF)</p>	<p>OFF</p> <ul style="list-style-type: none"> • At least 800×600 pixel resolution is required for the display.
<p>External Display Sync Pulse</p> <p>Selects the suitable pulse level for the connected external display from H and L. (default: H)</p>	<p>H</p>
<p>Opening Message</p> <p>Turns the opening message screen indication capability ON and OFF. (default: ON)</p>	<p>ON</p>

■ Display set mode (continued)

My Call

Sets the introductory text, up to 10-character long, displayed in the opening screen.

Usually, you set your call sign for the opening screen.

Capital letters, small letters, numerals, some symbols (- / . @) and spaces can be used.

- 1 Push [F-5•EDIT] to select the name edit condition.
 - The cursor under the 1st character blinks.
- 2 Push [ABC], [abc], [123] or [Symbol] to select the character group, then rotate the main dial to select the character.
 - Push [ABC] or [abc] to toggle capital and small letters.
 - Push [123] or [Symbol] to toggle numerals and symbols.
 - Push [F-1•◀] or [F-2•▶] for cursor movement.
 - Push [F-3•DEL] to delete the selected character.
 - Push [F-4•SPACE] to input a space.
 - Pushing the transceiver's keypad, [0]–[9], can also enter numerals.
- 3 Push [EXIT/SET] to set the name.

■ Miscellaneous (Others) set mode

Calibration Marker OFF

This item is used for a simple frequency check of the transceiver. (default: OFF)
See p. 13-5 for calibration procedure.

/// **NOTE:** Turn the calibration marker OFF after checking the frequency of the transceiver.

Beep (Confirmation) ON

A beep sounds each time a switch is pushed to confirm it. This function can be turned OFF for silent operation. (default: ON)

The beep output level can be set in level set mode. (p. 12-5)

Beep (Band Edge) ON

A beep sounds when an operating frequency enters or exits an amateur band. This functions independent of the confirmation beep setting (above). (default: ON)

The beep output level can be set in level set mode. (p. 12-5)

Beep Sound (MAIN) 1000Hz

Sets the desired key-touch beep sound frequency during main readout operation within 500 to 2000 Hz in 10 Hz steps. (default: 1000 Hz)

Set the different frequency from "Beep Sound (SUB)" as below to distinguish between main and sub.

Beep Sound (SUB) 1000Hz

Sets the desired key-touch beep sound frequency during sub readout operation within 500 to 2000 Hz in 10 Hz steps. (default: 1000 Hz)

Set the different frequency from "Beep Sound (MAIN)" as above to distinguish between main and sub.

Quick Dualwatch ON

When this item is set to ON, pushing [DUALWATCH] for 1 sec. sets the sub readout frequency to the main readout frequency and activates dualwatch operation. (default: ON)

See p. 5-16 for details.

■ Miscellaneous (Others) set mode (continued)

Quick SPLIT

ON

When this item is set to ON, pushing [SPLIT] for 1 sec. sets the sub readout frequency to the main readout frequency and activates split operation. (default: ON)

See p. 6-7 for details.

FM SPLIT Offset(HF)

-0.100MHz

Sets the offset (difference between transmit and receive frequencies) for the quick split function. This setting is used for HF bands in FM mode only and is used to input the repeater offset for an HF band.

The offset frequency can be set from -9.999 MHz to +9.999 MHz in 1 kHz steps. (default: -0.100 MHz)

FM SPLIT Offset(50M)

-0.500MHz

Sets the offset (difference between transmit and receive frequencies) for the quick split function. This setting is used for 50 MHz band FM mode only, and is used to input the repeater offset for the 50 MHz band.

The offset frequency can be set from -9.999 MHz to +9.999 MHz in 1 kHz steps. (default: -0.500 MHz)

SPLIT LOCK

OFF

When this item is ON, the main dial can be used to adjust the transmit frequency while pushing [XFC] even while the lock function is activated. (default: OFF)

See pgs. 6-6, 6-7 for split frequency operation details.

Tuner (Auto Start)

OFF

The internal antenna tuner has an automatic start capability which starts tuning if the SWR is higher than 1.5-3:1.

- OFF : The tuner remains OFF even when the SWR is poor (1.5-3:1). (default)
- ON : Automatic tune starts even when the tuner is turned OFF during HF bands operation.

Tuner (PTT Start)

OFF

Tuning of the internal antenna tuner can be started automatically at the moment the PTT is pushed after the operating frequency is changed (more than 1% from last-tuned frequency). (default: OFF)

Miscellaneous (Others) set mode (continued)

Transverter Function	Auto
<p>Selects the transverter operation condition from Auto and ON. (default: Auto)</p>	<ul style="list-style-type: none"> • ON : Turn the transverter operation ON. • Auto: The transceiver turns into transverter operation condition when 2 to 13.8 V DC is applied to [ACC2–A/B] pin 6.

Transverter Offset	16.000MHz (14.016.72 → 30.016.72)
<p>Sets the desired offset frequency for the transverter operation within 0.000 to 99.999 MHz in 1 kHz steps. (default: 16.000 MHz)</p>	

RTTY Mark Frequency	2125
<p>Selects the RTTY mark frequency. RTTY mark frequency is switched between 1275, 1615 and 2125 Hz. (default: 2125 Hz)</p> <p>2125 Hz is automatically selected when the internal RTTY decoder is used.</p>	

RTTY Shift Width	170
<p>Selects the RTTY shift width. There are 3 selectable values: 170, 200 and 425 Hz. (default: 170 Hz)</p> <p>170 Hz is automatically selected when the internal RTTY decoder is used.</p>	

RTTY Keying Polarity	Normal
<p>Selects the RTTY keying polarity. Normal or reverse keying polarity can be selected. (default: Normal)</p>	<p>When reverse polarity is selected, Mark and Space are reversed.</p> <ul style="list-style-type: none"> • Normal : Key open/close = Mark/Space • Reverse : Key open/close = Space/Mark

PSK Tone Frequency	1500
<p>Selects the desired PSK tone frequency for the PSK reception from 1000, 1500 and 2000 Hz. (default: 1500 Hz)</p>	

SPEECH Language	English
<p>Selects the speech language from English and Japanese. (default: English)</p>	

SPEECH Speed	HIGH
<p>Selects the speech speed from HIGH (faster) and LOW (slower). (default: HIGH)</p>	

■ Miscellaneous (Others) set mode (continued)

SPEECH S-Level ON

The IC-7800 speech processor has frequency, mode and signal level announcement. Signal level announcement can be deactivated if desired. (default: ON)

When "OFF" is selected, the signal level is not announced.

SPEECH [MODE] Switch OFF

Selects the operating mode speech capability when a mode switch is pushed; ON or OFF. (default: OFF)

When "ON" is selected, the selected operating mode is announced when a mode switch is pushed.

Memopad Numbers 5

Sets the number of memo pad channels available. 5 or 10 memo pads can be set. (default: 5)

MAIN DIAL Operation MAIN/SUB

Selects the main dial function from MAIN and MAIN/SUB. (default: MAIN/SUB)

- MAIN : The main dial functions only when accessing to main readout.
- MAIN/SUB : The main dial functions when accessing to main readout, as well as when accessing to sub readout with [SUB] switch operation.

MAIN DIAL Auto TS HIGH

Sets the auto tuning step function for the main dial. When rotating the main dial rapidly, the tuning step automatically changes several times as selected.

There are 2 type of auto tuning steps: HIGH (Fastest) and LOW (Faster). (default: HIGH)

- HIGH : Auto tuning step is turned ON. Fastest tuning step during rapid rotation. (default)
- LOW : Auto tuning step is turned ON. Faster tuning step during rapid rotation.
- OFF : Auto tuning step is turned OFF.

SUB DIAL Auto TS HIGH

Sets the auto tuning step function for the sub dial. When rotating the sub dial rapidly, the tuning step automatically changes several times as selected.

There are 2 type of auto tuning steps: HIGH (Fastest) and LOW (Faster). (default: HIGH)

- HIGH : Auto tuning step is turned ON. Fastest tuning step during rapid rotation. (default)
- LOW : Auto tuning step is turned ON. Faster tuning step during rapid rotation.
- OFF : Auto tuning step is turned OFF.

Miscellaneous (Others) set mode (continued)

MIC Up/Down Speed	HIGH
Sets the rate at which frequencies are scanned when the microphone [UP]/[DN] switches are pushed and held. High or low can be selected.	<ul style="list-style-type: none"> • HIGH : High speed (default; 50 tuning steps/sec.) • LOW : Low speed (25 tuning steps/sec.)

Quick RIT/ΔTX Clear	OFF
Selects the RIT/ΔTX frequency clearing instruction with the [CLEAR] switch.	<ul style="list-style-type: none"> • ON : Clears the RIT/ΔTX frequency when [CLEAR] is pushed momentarily. • OFF : Clears the RIT/ΔTX frequency when [CLEAR] is pushed for 1 sec. (default)

[NOTCH] Switch (SSB)	Auto/Manual
Selects notch functions for SSB mode operation from Auto, Manual and Auto/Manual.	<ul style="list-style-type: none"> • Auto : The auto notch can only be used. • Manual : The manual notch can only be used. • Auto/Manual : Both the auto and manual notch can be used. (default)

[NOTCH] Switch (AM)	Auto/Manual
Selects notch functions for AM mode operation from Auto, Manual and Auto/Manual.	<ul style="list-style-type: none"> • Auto : The auto notch can only be used. • Manual : The manual notch can only be used. • Auto/Manual : Both the auto and manual notch can be used. (default)

DIGI-SEL VR Operation	DIGI-SEL
Selects [DIGI-SEL] control function from DIGI-SEL and APF.	<ul style="list-style-type: none"> • DIGI-SEL : [DIGI-SEL] control functions as the digital selector operation. (default) • APF : [DIGI-SEL] control functions as the audio peak filter adjustment.

FILTER Screen MAIN/SUB Select	Auto (by FILTER,PBT Operation)
Selects filter set screen indication condition from Fix and Auto (by FILTER,PBT Operation).	<ul style="list-style-type: none"> • Fix : When filter screen accessed with the main band's [FILTER] switch, the screen shows main band's filter width and PBT conditions only; when filter set screen accessed with the sub band's [FILTER] switch, the screen shows sub band's filter width and PBT conditions only. • Auto (by FILTER,PBT Operation) : Filter set screen indication can be switched between main and sub bands filter width and PBT conditions when either band's [FILTER] switch or [TWIN PBT] control is operated. (default)

■ Miscellaneous (Others) set mode (continued)

SSB/CW Synchronous Tuning

OFF

Selects the displayed frequency shift function from ON and OFF. (default: OFF)

When this function is activated, the receiving signal can be kept to receive even when the operating mode is changed between SSB and CW.

/// The frequency shifting value may differ according to the CW pitch setting.

- ON : The displayed frequency shifts when the operating mode is changed between SSB and CW.
- OFF : The displayed frequency does not shift.

CW Normal Side

LSB

Selects the side band used to receive CW in CW normal mode. (default: LSB)

APF Type

SOFT

Set audio filter shape for APF from SOFT and SHARP. (default: SOFT)

- SOFT : Soft filter shape makes distinguishing noise and signals easier. The audio filter width is related to the CW pitch setting.
- SHARP : Sharp filter shape rejects interference signals. The audio filter width is fixed.

MIC AF Out

MAIN+SUB

Selects the desired band(s) for audio output from [MIC] connector (pin 8) from MAIN+SUB and SUB. (default: MAIN+SUB)

- MAIN+SUB : Outputs both main and sub bands audio.
- SUB : Outputs sub band audio only.

External Keypad (VOICE)

OFF

Sets the external keypad for voice memory transmission capability ON and OFF.

See page 2-6 for the equivalent circuit of an external keypad and connection.

- ON : Pushing one of external keypad switches, transmits the desired voice memory contents during a phone mode operation.
- OFF : External keypad does not function. (default)

External Keypad (KEYER)

OFF

Sets the external keypad for keyer memory transmission capability ON and OFF.

See page 2-6 for the equivalent circuit of an external keypad and connection.

- ON : Pushing one of external keypad switches, transmits the desired keyer memory contents during CW mode operation.
- OFF : External keypad does not function. (default)

Miscellaneous (Others) set mode (continued)

CI-V Baud Rate	Auto
<p>Sets the CI-V data transfer rate. 300, 1200, 4800, 9600, 19200 bps and "Auto" are available. (default: Auto)</p> <p>When "Auto" is selected, the baud rate is automatically set according to the data rate of connected controller.</p>	

CI-V Address	6Ah
<p>To distinguish equipment, each CI-V transceiver has its own Icom standard address in hexadecimal code. The IC-7800's address is 6Ah.</p> <p>When 2 or more IC-7800's are connected to an optional CT-17 CI-V LEVEL CONVERTER, rotate the main dial to select a different address for each IC-7800; the range is 01h to 7Fh.</p>	

CI-V Transceive	ON
<p>Transceive operation is possible with the IC-7800 connected to other Icom HF transceivers or receivers.</p> <p>When "ON" is selected, changing the frequency, operating mode, etc. on the IC-7800 automatically changes those of connected transceivers (or receivers) and vice versa.</p>	

RS-232C Function	CI-V
<p>Select [RS-232C] connector output data format from CI-V and Decode.</p>	<ul style="list-style-type: none"> • CI-V : Outputs data in CI-V format. (default) • Decode : Outputs decoded contents in ASCII code format.

Decode Baud Rate	9600
<p>Selects data transmission speed (Baud rate) when "Decode" is selected in "RS-232C Function" above; settings are 300, 1200, 4800, 9600 and 19200 bps. (default: 9600)</p>	

Keyboard Type	English
<p>Selects the connected keyboard type from Japanese, English, United Kingdom, French, French (Canadian), German, Portuguese, Portuguese (Brazilian), Spanish, Spanish (Latin American) and Italian. (default: English)</p>	

■ Miscellaneous (others) set mode (continued)

Keyboard Repeat Delay 250ms

Sets the time period for delay within 100 to 1000 msec. in 50 msec. steps. (default: 250 msec.)

When a key of the connected keyboard is pressed and held for the set period, the character is input continuously.

Keyboard Repeat Rate 10.9cps

Sets the repeating rate for the connected keyboard within 2.0 to 30.0 cps in 0.1 cps steps.

(default: 10.9 cps) *cps=character per second

When a key of the connected keyboard is pressed and held, the character is repeatedly input with the set speed.

IP Address (Valid after Reboot) 192.168. 0. 1

Sets IP address for the IC-7800 when connecting to your PC or LAN (Local Area Network) through the Ethernet connector.

Turn the transceiver power OFF then ON to make the setting effective. See p. 16-7 for details.

Subnet Mask (Valid after Reboot) 255.255.255. 0 (24bit)

Sets subnet mask for the IC-7800 when connecting to your PC or LAN (Local Area Network) through the Ethernet connector.

Turn the transceiver power OFF then ON to make the setting effective. See p. 16-7 for details.

■ CF card set menu

◇ CF card set screen arrangement

• CF card set menu

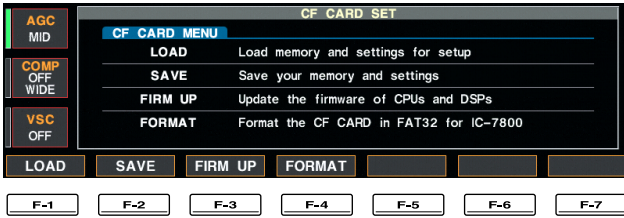

• Format menu (p. 12-28)

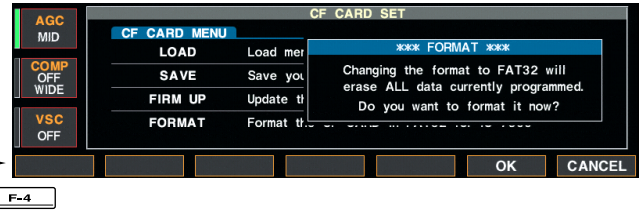

• Setting load screen (p. 12-26)

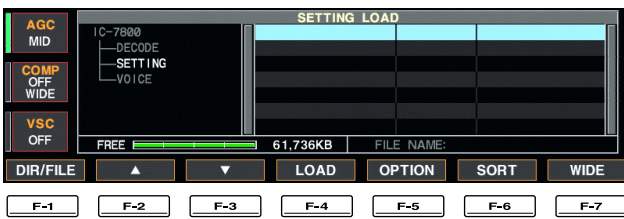

• Setting save screen (p. 12-25)

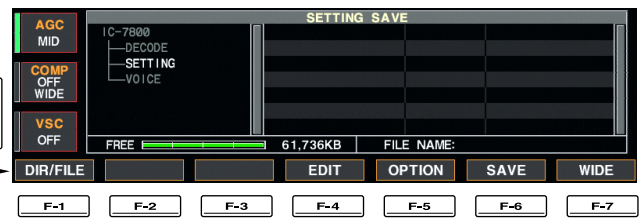

• Load option set mode (p. 12-24)

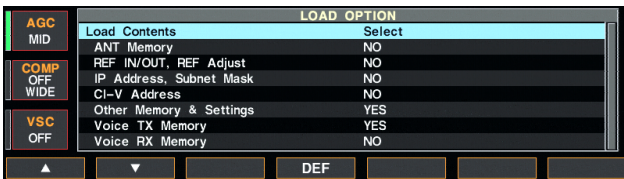

• Save option set mode (p. 12-23)

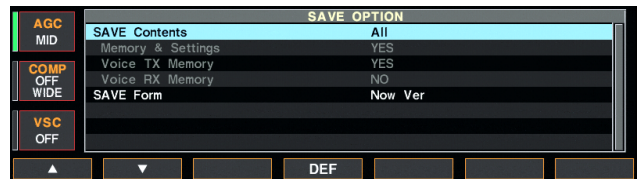

• Firmware update (p. 16-4)

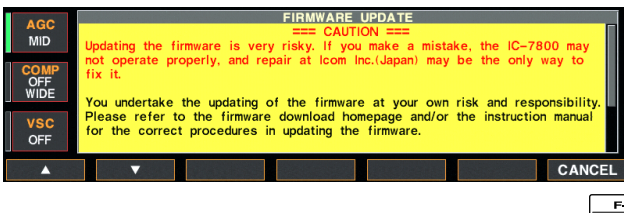

◇ Save option set mode

SAVE Contents

All

Selects file saving condition from All and Select.
(default: All)

- All : Saves all the following contents.
- Select : Saves the selected contents only.

Memory & Settings

YES

Selects memory channel contents and other settings saving condition from YES and NO. (default: YES)

- YES : Saves memory channel contents and settings of miscellaneous (Other) set mode.
- NO : Does not save.

Voice TX Memory

YES

Selects the voice TX memory saving condition from YES and NO. (default: YES)

- YES : Saves the voice TX memory.
- NO : Does not save.

Voice RX Memory

NO

Selects the voice RX memory saving condition from YES and NO. (default: NO)

- YES : Saves the voice RX memory.
- NO : Does not save.

SAVE Form

Now Ver

Selects file saving format from Now Ver and Old Ver.
(default: Now Ver)
Additional selections are available for Old Ver and indicated in brackets.

- Now Ver : Saves the file in the current firmware version format being used.
- Old Ver : Saves the file in the firmware version format that is indicated in brackets.

◇ Load option set mode

Load Contents	Select
<p>Selects file loading condition from All and Select. (default: Select)</p>	<ul style="list-style-type: none"> • All : Loads and sets the all following contents. • Select : Loads and sets the selected contents only.
<p>ANT Memory</p>	<p>NO</p>
<p>Selects the antenna memory setting loading condition YES and NO. (default: NO).</p>	<ul style="list-style-type: none"> • YES : Loads and sets the antenna memory. • NO : Use the original antenna memory setting.
<p>REF IN/OUT, REF Adjust</p>	<p>NO</p>
<p>Selects the reference signal setting loading condition YES and NO. (default: NO).</p>	<ul style="list-style-type: none"> • YES : Loads and sets the reference signal setting. • NO : Use the original reference signal setting.
<p>IP Address, Subnet Mask</p>	<p>NO</p>
<p>Selects the IP address and subnet mask setting loading condition YES and NO. (default: NO).</p>	<ul style="list-style-type: none"> • YES : Loads and sets the IP address and subnet mask setting. • NO : Use the original IP address and subnet mask setting.
<p>CI-V Address</p>	<p>NO</p>
<p>Selects the CI-V address setting loading condition YES and NO. (default: NO).</p>	<ul style="list-style-type: none"> • YES : Loads and sets the CI-V address setting. • NO : Use the original CI-V address setting.
<p>Other Memory & Settings</p>	<p>YES</p>
<p>Selects memory channel contents and other settings loading condition YES and NO. (default: YES).</p>	<ul style="list-style-type: none"> • YES : Loads and sets memory channel contents and other settings. • NO : Use the original memory channel contents and other settings.
<p>Voice TX Memory</p>	<p>YES</p>
<p>Selects the voice TX memory loading condition YES and NO. (default: YES).</p>	<ul style="list-style-type: none"> • YES : Loads and sets the voice TX memory. • NO : Use the original the voice TX memory.
<p>Voice RX Memory</p>	<p>NO</p>
<p>Selects the voice RX memory loading condition YES and NO. (default: NO).</p>	<ul style="list-style-type: none"> • YES : Loads and sets the voice RX memory. • NO : Use the original the voice RX memory.

■ File saving

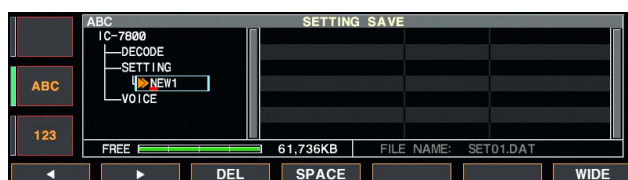
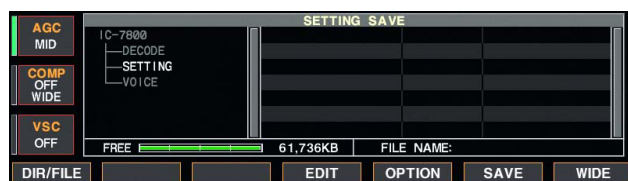
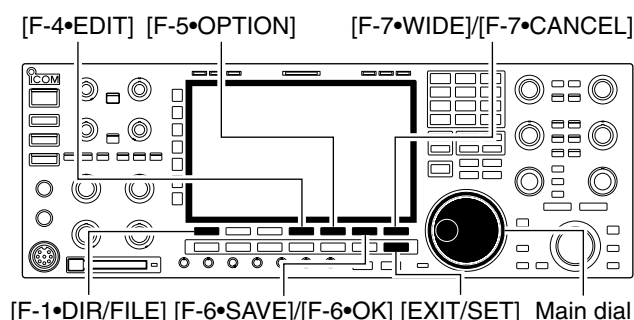

Memory channel contents, set mode settings, etc. can be saved into the CF (Compact Flash) memory card for backup.

- ① During set mode menu screen indication, push [F-7•CF CARD] to select CF card set menu screen.
- ② Push [F-2•SAVE] to select setting save screen.
- ③ Change the following conditions if desired.

• File name:

- ① Push [F-4•EDIT] to select file name edit condition.
 - Push [F-1•DIR/FILE] several times to select the file name, if necessary.
- ② Push [ABC], [123] or [Symbol] to select the character group, then rotate the main dial to select the character.
 - [ABC] : A to Z (capital letters); [123]: 0 to 9 (numerals); [Symbol]: ! # \$ % & ' ` ^ + - = () [] { } _ ~ @ can be selected.
 - Push [F-1•◀] to move the cursor left, push [F-2•▶] to move the cursor right, push [F-3•DEL] to delete a character and push [F-4•SPACE] to insert a space.
- ③ Push [EXIT/SET] to set the file name.

• Save option

- ① Push [F-5•OPTION] to enter save option set mode.
- ② Push [F-1•▲] or [F-2•▼] to select the item, then rotate the main dial to select the desired setting. (see p. 12-23 for details)
 - “Text” is the default setting.
 - Push [F-4•DEF] for 1 sec. to select the default setting.
- ③ Push [EXIT/SET] to return to the previous indication.

• Saving location

- ① Push [F-1•DIR/FILE] to select tree view screen.
- ② Select the desired directory or folder in the CF memory card.
 - Push [F-4•◀▶] to select the upper directory.
 - Push [F-2•▲] or [F-3•▼] to select folder in the same directory.
 - Push [F-4•◀▶] for 1 sec. to select a folder in the directory.
 - Push [F-5•REN/DEL] to rename the folder.
 - Push [F-5•REN/DEL] for 1 sec. to delete the folder.
 - Push [F-6•MAKE] for 1 sec. to making a new folder. (Edit the name with the same manner as the “• File name” above.)
- ③ Push [F-1•DIR/FILE] twice to select the file name.

- ④ Push [F-6•SAVE].
 - Confirmation screen appears.
- ⑤ Push [F-6•OK] to save.
 - After saving is completed, return to CF card set menu automatically.

File loading

[F-4•LOAD] [F-5•OPTION] [F-7•WIDE]/[F-7•CANCEL]

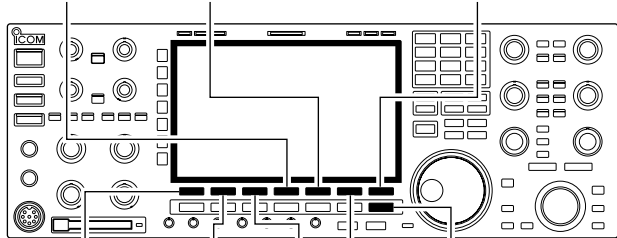

[F-1•DIR/FILE] [F-2•▲] [F-3•▼] [EXIT/SET]
[F-6•SORT]/[F-6•OK]



By loading the saved setting file from the CF card, you can easily set up another IC-7800— several operators settings can easily be applied to one IC-7800.

- ① During set mode menu screen indication, push [F-7•CF CARD] to select CF card set menu screen.
- ② Push [F-1•LOAD] to select setting load screen.
 - The indicator beside the CF card slot blinks.
 - After the CF card contents are displayed, the indicator goes off.
- ③ Push [F-5•OPTION] to select load option set mode, then set the desired loading conditions, if desired.
 - See page 12-24 for details.
- ④ Push [F-2•▲] or [F-3•▼] to select the desired setting file.
- ⑤ Push [F-4•LOAD].
 - Confirmation screen appears.
- ⑥ Push [F-6•OK] to starts loading.
 - After the loading is completed, the message dialog, “Reboot the IC-7800,” appears.
- ⑦ Turn the transceiver power OFF then ON to make the setting effective .

■ Changing the file name

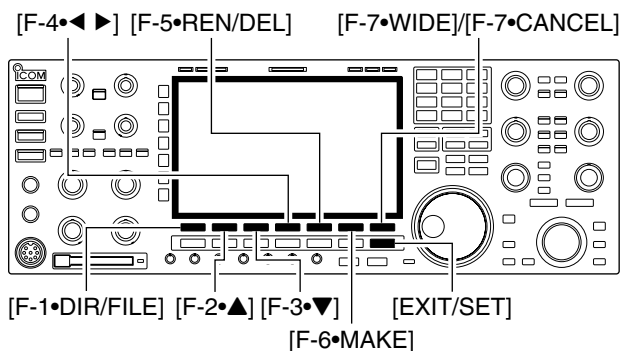

The file name, saved in the CF card, can be re-named from the transceiver as desired.

- ① During setting save screen display, push [F-1•DIR/FILE] to select tree view screen.
 - Push [F-2•▲] or [F-3•▼] to select the desired folder.
 - “DECODE,” “SETTING” and “VOICE” folders are available as the default.
 - After the folder is selected, push [F-2•◀▶] for 1 sec. to display content folder(s), if available.
- ② Push [F-1•DIR/FILE] to select file list screen.
- ③ Push [F-2•▲] or [F-3•▼] to select the desired file.
- ④ Push [F-5•REN/DEL] momentarily to select the file name edit condition.
- ⑤ Push [ABC], [123] or [Symbol] to select the character group, then rotate the main dial to select the character.
 - [ABC] : A to Z (capital letters); [123]: 0 to 9 (numerals); [Symbol]: ! # \$ % & ' ^ + - = () [] { } _ ~ @ can be selected.
 - Push [F-1•◀] to move the cursor left, push [F-2•▶] to move the cursor right, push [F-3•DEL] to delete a character and push [F-4•SPACE] to insert a space.
 - Pushing the transceiver’s keypad, [0]–[9], can also enter numerals.
- ⑥ Push [EXIT/SET] to set the file name.

■ Deleting a file



RECOMMENDATION! Deleting the setting file is irreversible. Confirm the contents before deleting a setting file!

- ① During setting save screen display, push [F-1•DIR/FILE] to select tree view screen.
 - Push [F-2•▲] or [F-3•▼] to select the desired folder.
 - “DECODE,” “SETTING” and “VOICE” folders are available as the default.
 - After the folder is selected, push [F-2•◀▶] for 1 sec. to display content folder(s), if available.
- ② Push [F-1•DIR/FILE] to select file list screen.
- ③ Push [F-2•▲] or [F-3•▼] to select the desired file to be deleted.
- ④ Push [F-5•REN/DEL] for 1 sec.
 - Confirmation screen appears.
- ⑤ Push [F-6•OK] to delete.
 - After the deleting, return to setting save screen automatically.

■ Formatting the CF card

A saved data in the CF memory card can be erased.

IMPORTANT! Formatting erases all saved data in the CF memory card. Making a backup file on your PC is recommended.



- ① During CF card set menu display, push [F-4•FORMAT] for 1 sec.
 - Confirmation screen appears.
- ② Push [F-6•OK] to format.
 - Push [F-7•CANCEL] to cancel.
- ③ Returns to CF card set menu indication automatically.

- Troubleshooting 13-2
 - ◇ Transceiver power 13-2
 - ◇ Transmit and receive 13-2
 - ◇ Scanning 13-3
 - ◇ Display 13-3
- Main dial brake adjustment 13-3
- Voice synthesizer operation 13-3
- SWR reading 13-4
- Screen type and font selections 13-4
- Frequency calibration (approximate) 13-5
- Opening the transceiver's case 13-6
- Clock backup battery replacement 13-6
- Fuse replacement 13-7
- Resetting the CPU 13-7
- About protection indications 13-8
- Screen Saver Function 13-8

■ Troubleshooting

The following chart is designed to help you correct problems which are not equipment malfunctions. If you are unable to locate the cause of a problem or solve it through the use of this chart, contact your nearest Icom Dealer or Service Center.

◇ Transceiver power

PROBLEM	POSSIBLE CAUSE	SOLUTION	REF.
Power does not come on when the [POWER] switch is pushed.	<ul style="list-style-type: none"> • Power cable is improperly connected. • The internal power supply is turned OFF. • Circuit breaker is tripped. 	<ul style="list-style-type: none"> • Re-connect the AC power cable correctly. • Turn the internal power supply ON. • Check for the cause, then re-set the circuit breaker. 	<p>p. 2-4 p. 3-2 —</p>

◇ Transmit and receive

PROBLEM	POSSIBLE CAUSE	SOLUTION	REF.
No sounds come out from the speaker.	<ul style="list-style-type: none"> • Volume level is too low. • The squelch is closed. • The transceiver is in transmitting condition. 	<ul style="list-style-type: none"> • Rotate [AF] clockwise to obtain a suitable listening level. • Turn [SQL] to 10 o'clock position to open the squelch. • Push [TRANSMIT] to receive or check the SEND line of an external unit, if connected. 	<p>p. 3-9 p. 3-9 p. 3-12</p>
Sensitivity is too low, and only strong signals are audible.	<ul style="list-style-type: none"> • The antenna is not connected properly. • The antenna for another band is selected. • The antenna is not properly tuned. • The attenuator is activated. 	<ul style="list-style-type: none"> • Re-connect to the antenna connector. • Select an antenna suitable for the operating frequency. • Push [TUNER] for 1 sec. to manually tune the antenna. • Push [ATT] several times to select "ATT OFF." 	<p>— p. 10-2 p. 10-5 p. 5-9</p>
Received audio is unclear or distorted.	<ul style="list-style-type: none"> • Wrong operating mode is selected. • PBT function is activated. • Noise blanker is turned ON when receiving a strong signal. • Preamp is activated. • The noise reduction is activated and the [NR] control is too far clockwise. 	<ul style="list-style-type: none"> • Select a suitable operating mode. • Push [PBT CLR] for 1 sec. to reset the function. • Push [NB] to turn the noise blanker OFF. • Push [P.AMP] once or twice to turn the function OFF. • Set the [NR] control for maximum readability. 	<p>p. 3-8 p. 5-12 p. 5-17 p. 5-9 p. 5-18</p>
The [ANT] switch does not function	<ul style="list-style-type: none"> • The antenna switch has not been activated. 	<ul style="list-style-type: none"> • Set the antenna switch in set mode to "Auto" or "Manual." 	<p>p. 10-4</p>
Transmitting is impossible.	<ul style="list-style-type: none"> • The operating frequency is not inside a ham band. 	<ul style="list-style-type: none"> • Set the frequency to be in a ham band. 	<p>p. 3-5</p>
Output power is too low.	<ul style="list-style-type: none"> • [RF PWR] is set too far counterclockwise • [DRIVE] is set too far counterclockwise • [MIC] is set too far counterclockwise • The antenna for another band is selected. • The antenna is not properly tuned. 	<ul style="list-style-type: none"> • Rotate [RF PWR] clockwise. • Set [DRIVE] to a suitable position. • Set [MIC] to a suitable position. • Select an antenna suitable for the operating frequency. • Push [TUNER] for 1 sec. to manually tune the antenna. 	<p>p. 3-12 p. 3-13 p. 3-12 p. 10-2 p. 10-5</p>
No contact possible with another station.	<ul style="list-style-type: none"> • RIT or ΔTX function is activated. • Split frequency function and/or dualwatch are activated. 	<ul style="list-style-type: none"> • Push [RIT] or [ΔTX] to turn the function OFF. • Push [SPLIT] and/or [DUALWATCH] to turn the function OFF. 	<p>pgs. 5-10, 6-4 pgs. 5-16, 6-4</p>
Transmit signal is unclear or distorted.	<ul style="list-style-type: none"> • [MIC] is set too far clockwise 	<ul style="list-style-type: none"> • Set [MIC] to a suitable position. 	<p>p. 3-12</p>
Repeater cannot be accessed.	<ul style="list-style-type: none"> • Split frequency function is not activated. • Programmed subaudible tone frequency is wrong. 	<ul style="list-style-type: none"> • Push [SPLIT] to turn the function ON • Reset the frequency using set mode. 	<p>p. 6-6 p. 4-32</p>

◇ Scanning

PROBLEM	POSSIBLE CAUSE	SOLUTION	REF.
Programmed scan does not stop.	• Squelch is open.	• Set [SQL] to the threshold point.	p. 3-9
Programmed scan does not start.	• The same frequencies have been programmed in scan edge memory channels P1 and P2.	• Program different frequencies in scan edge memory channel P1 and P2.	p. 8-4
Memory scan does not start	• 2 or more memory channels have not been programmed.	• Program more than 2 memory channels.	p. 8-4
Select memory scan does not start	• 2 or more memory channels have not been designated as select channels.	• Designate more than 2 memory channels as select channels for the scan.	p. 9-7

◇ Display

PROBLEM	POSSIBLE CAUSE	SOLUTION	REF.
The displayed frequency does not change properly.	• The dial lock function is activated.	• Push [LOCK] to turn the function OFF.	p. 5-18
	• A set mode screen is selected.	• Push [EXIT/SET] several times to exit the set mode screen.	p. 12-2
	• The internal CPU has malfunctioned.	• Reset the CPU.	p. 13-7

■ Main dial brake adjustment

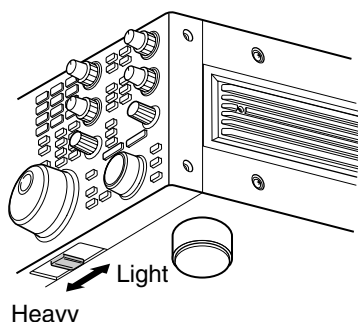

The tension of the main dial may be adjusted to suit you preference.

The brake adjustment is located on the bottom side of the front panel. See the figure at left.

Slide the brake adjustment to comfortable tension level while turning the dial continuously and evenly in one direction.

■ Voice synthesizer operation

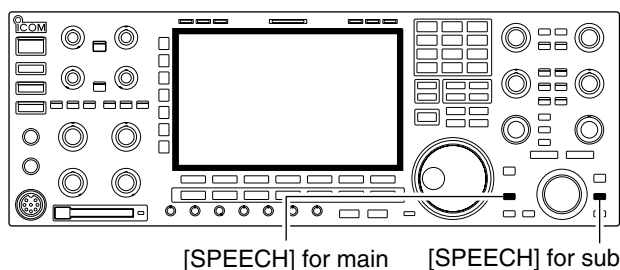

The IC-7800 has built-in voice synthesizer to announce the frequency, mode, etc. (S-meter level can also be announced—p. 12-17) in clear, electronically-generated voice, in English (or Japanese).

- Push [SPEECH] to announce the currently selected frequency, etc.
 - Push [SPEECH] for 1 sec. to additionally announce the selected mode.
- Pushing a mode switch also announces the appropriate mode. (p. 12-17)

▨ The output level of the voice synthesizer can be adjusted in level set mode. (p. 12-5)

SWR reading

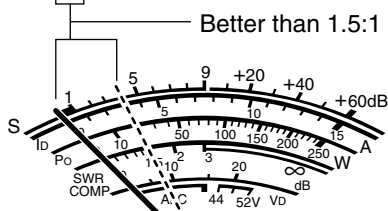
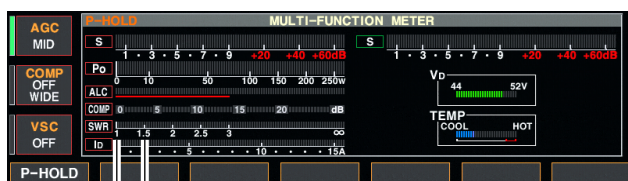
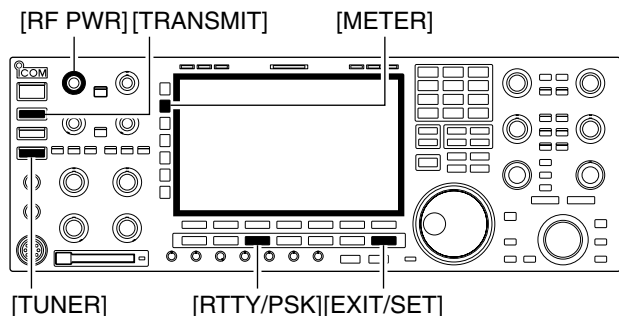

The SWR meter indicates the SWR over the transmission line in all modes.

- ① Push [TUNER] to turn the antenna tuner OFF.
- ② Push [METER] for 1 sec. to display multi-function meter.
- ③ Push [RTTY/PSK] once or twice to select RTTY mode.
- ④ Push [TRANSMIT].
- ⑤ Rotate [RF PWR] clockwise past the 12 o'clock position for more than 30 W output power.
- ⑥ Read the SWR on the SWR meter gage.
- ⑦ Push [EXIT/SET] to close multi-function meter.

▨ The built-in antenna tuner matches the transmitter to the antenna when the SWR is lower than 3 : 1.

Screen type and font selections

• Screen image example— type C



3 types of screen images and 18 types of frequency readout indication fonts are available in the IC-7800.

- ① Push [EXIT/SET] several times to close multi-function screen, if necessary.
- ② Push [F-7•SET] to select set mode menu screen.
- ③ Push [F-3•DISP] to enter display set mode.
- ④ Push [F-1•▲] or [F-2•▼] to select “Display Type” item when selecting the screen image, select “Display Font” when selecting the frequency readout indication font.
- ⑤ Rotate the main dial to select the desired screen image or font.
 - Screen image is selectable from A, B and C.
 - Italic (1)/(2)/(3)/(4), Round (1)/(2)/(3), Shadow (1)/(2)/(3), Qubic (1)/(2)/(3)/(4) and IC-780 (1)/(2)/(3)/(4) are available for the frequency readout font.
- ⑥ Push [EXIT/SET] twice to exit from display set mode.

■ Frequency calibration (approximate)

A very accurate frequency counter is required to calibrate the frequency of the transceiver. However, a rough check may be performed by receiving radio station WWV, WWVH, or other standard frequency signals.

CAUTION: The IC-7800 has been thoroughly adjusted and tested at the factory before being shipped. You should not have to re-calibrate it.

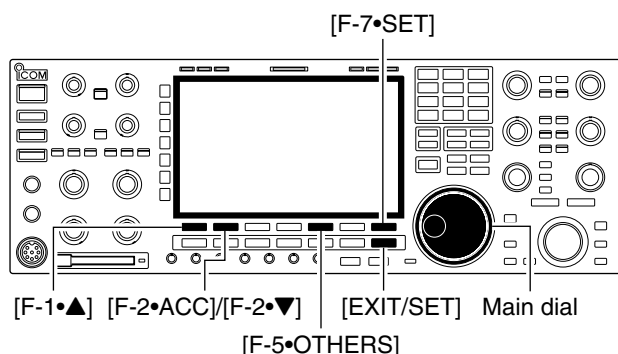

- ① Push [SSB] to select USB mode.
- ② Push [PBT CLEAR] for 1 sec. to clear the PBT setting and make sure that the RIT/ Δ TX function is not activated.
- ③ Set the frequency to the standard frequency station minus 1 kHz.
 - When receiving WWV or WWVH (at 15.00000 MHz) as a standard frequency, set the operating frequency for 14.99900 MHz.
 - Other standard frequencies can be used.
- ④ Push [EXIT/SET] several times to close a multi-function screen, if necessary.
- ⑤ Push [F-7•SET] to select set mode menu screen.
- ⑥ Push [F-5•OTHERS] to enter miscellaneous (others) set mode.
- ⑦ Push [F-1•▲] several times to select the “Calibration Marker” item.
- ⑧ Rotate the main dial clockwise to turn the calibration marker ON.
- ⑨ Push [EXIT/SET] once to return to set mode menu screen.
- ⑩ Push [F-2•ACC] to enter accessory set mode.
- ⑪ Push [F-2•▼] several times to select the “REF Adjust” item.
- ⑫ Rotate the main dial to adjust for a zero beat with the received standard signal as shown at left.
 - Zero beat means that two signals are exactly the same frequency, resulting in a single tone being emitted.
- ⑬ Turn the calibration marker OFF in miscellaneous (others) set mode.
- ⑭ Push [EXIT/SET] twice to exit set mode.

• Calibration marker item



• REF Adjust item

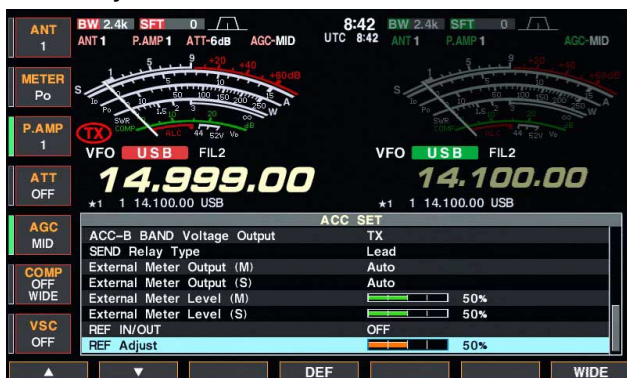

■ Opening the transceiver's case

Follow the case opening procedures shown here when you want to replace the clock backup battery or internal fuse.

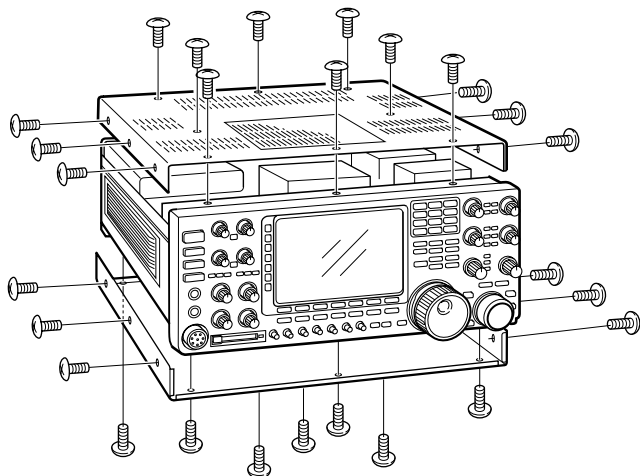

CAUTION!: DISCONNECT the AC power cable from the transceiver before performing any work on the transceiver. Otherwise, there is danger of electric shock and/or equipment damage.

CAUTION!: The transceiver weighs approx. 25 kg (55 lb). Always have two people available to lift or invert over the transceiver.

- ① Remove the 8 screws from the top of the transceiver and the 6 screws from the sides, then lift up the top cover.
- ② Turn the transceiver upside-down.

CAUTION: NEVER HOLD THE MAIN DIAL OR ANY OTHER KNOBS when the transceiver is upside down. This may damage the transceiver.

- ③ Remove 7 screws from the bottom, and the 6 screws from the sides, then lift up the bottom cover.

■ Clock backup battery replacement

The IC-7800 has a lithium backup battery (CR2032) inside for clock and timer functions. The usual life of the backup battery is approximately 2 years.

When the backup battery exhausted, the transceiver transmits and receives normally but cannot retain the current time.

WARNING: DISCONNECT the AC power cable from the AC outlet before removing the transceiver's cover.

- ① Remove the top cover as shown above.
- ② Replace the clock backup battery, located on the front panel as illustrated at left.
 - Make sure the battery polarity is correct.
- ③ Return the top cover to the original position.
- ④ Set the date and time in time set mode. (p. 11-2)

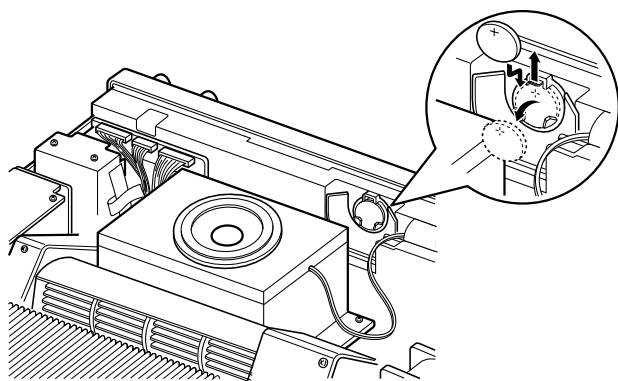

■ Fuse replacement

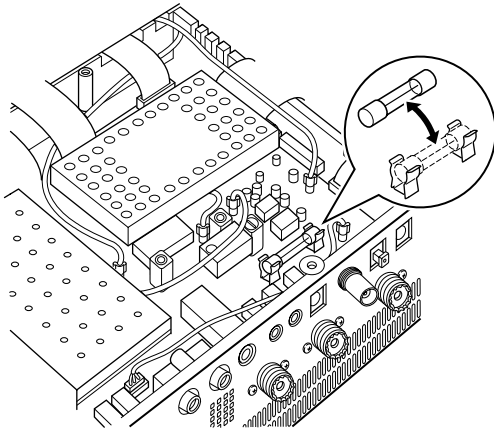

When no external DC output is available from [EXT DC] and ACC connectors, the internal fuse may be open. Replace the fuse in this case.

WARNING: DISCONNECT the AC power cable from the AC outlet before removing the transceiver's cover.

- ① Remove the bottom cover as shown left.
- ② Replace the open fuse with a new, properly rated one (FGB 2 A) as shown at left.
- ③ Replace the bottom cover.

■ Resetting the CPU

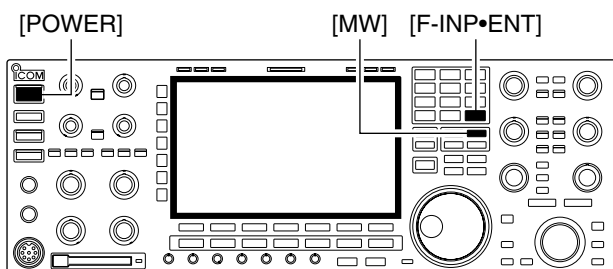

- ① Turn the main power switch on the rear panel ON.
 - Make sure the transceiver power is still OFF.
- ② While pushing and holding [F-INP•ENT] and [MW], push [POWER] to turn power ON.
 - The internal CPU is reset.
 - The CPU start-up takes approx. 5 sec.
 - The transceiver displays its initial VFO frequencies when resetting is complete.
- ③ Correct the set mode settings after resetting, if desired.

NOTE: Resetting **CLEARs** all programmed contents in memory channels and returns programmed values in set mode to default values.

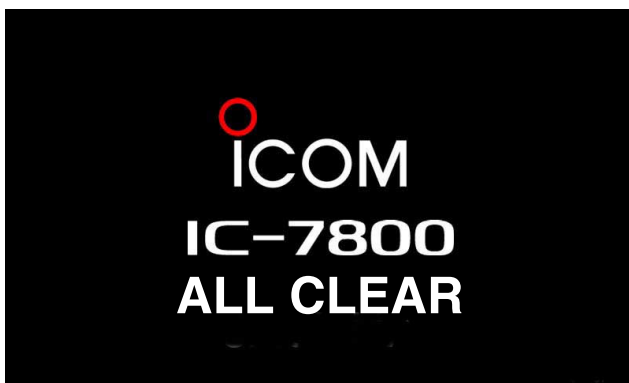

About protection indications

The IC-7800 has a 2-step protection function to protect the final power amplifiers.

The protector detects the power amplifier temperature and activates when the temperature becomes extremely high.

- **Power down transmission**
Reduces the transmit output power to 100 W.
“LMT” appears beside the transmit indicator during transmit.
- **Transmission inhibit**
Deactivates the transmitter.
The transmit indicator is displayed in gray during transmit.

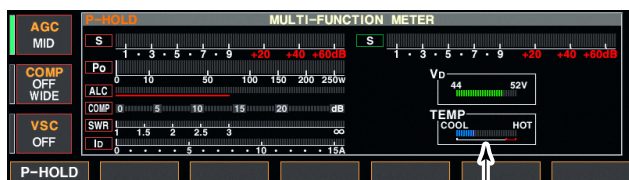

Check the temperature

When the protector is activated, wait until the power amplifier cools down using the transceiver in stand-by or receive condition.

NOTE: DO NOT turn the transceiver power OFF. The internal cooling fan does not function, so it will take longer to cool the transceiver.

The power amplifier temperature can be monitored in the multi-function meter, TEMP gauge.

Screen saver function

The IC-7800 has a screen saver function to protect the LCD from the “burn-in” effect.

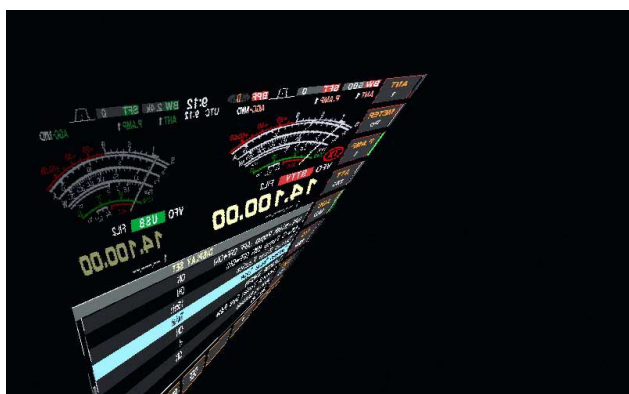
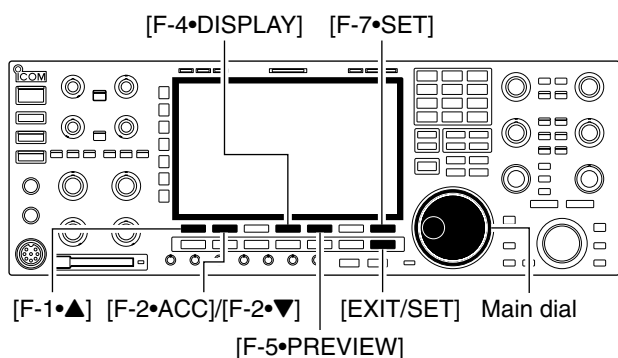

- ① Push [EXIT/SET] several times to close a multi-function screen, if necessary.
- ② Push [F-7•SET] to select set mode menu screen.
- ③ Push [F-4•DISPLAY] to enter display set mode.
- ④ Push [F-1•▲]/[F-2•▼] several times to select the “Screen Saver Function” item.
- ⑤ Rotate main dial to select the desired time period for the screen saver activation from 15, 30, 60 min. and OFF.
 - Deactivate the screen saver with “OFF” selection.
- ⑥ Push [F-2•▼] to select the “Screen Saver Type” item.
- ⑦ Rotate main dial to select the screen saver type from “Bound,” “Rotation” and “Twist.”
 - Push and hold [F-5•PREVIEW] to display the indication for your reference.
- ⑧ Push [EXIT/SET] twice to exit set mode.

- Remote jack (CI-V) information 14-2
 - ◇ CI-V connection example 14-2
 - ◇ Data format 14-2
 - ◇ Command table 14-9
 - ◇ To send/read memory contents 14-9
 - ◇ Band stacking register 14-9
 - ◇ Codes for memory keyer contents 14-9
 - ◇ Codes for memory name, opening message
and clock 2 name contents 14-9
 - ◇ Offset frequency setting 14-10
 - ◇ Repeater tone/tone squelch frequency setting 14-10
 - ◇ SSB transmission passband width setting 14-10
 - ◇ Color setting 14-10
 - ◇ Bandscope edge frequency setting 14-10
 - ◇ Data mode with filter width setting 14-10
 - ◇ Antenna memory setting 14-10

Remote jack (CI-V) information

CI-V connection example

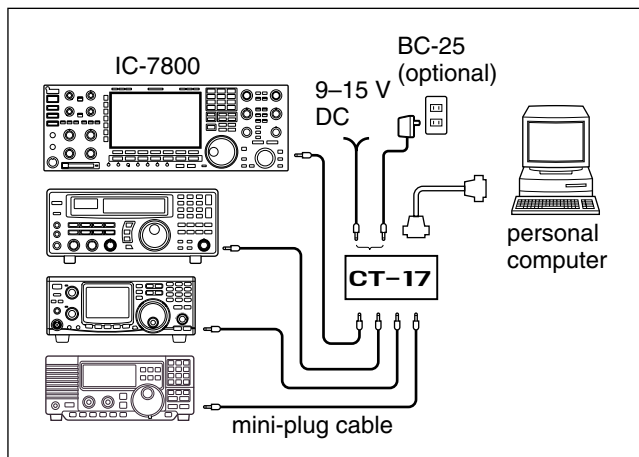

The transceiver can be connected through an optional CT-17 CI-V LEVEL CONVERTER to a PC equipped with an RS-232C port. The Icom Communications Interface-V (CI-V) controls of the transceiver.

Up to 4 Icom CI-V transceivers or transceivers can be connected to a PC equipped with an RS-232C port. See p. 12-20 for setting the CI-V condition using set mode.

Data format

The CI-V system can be operated using the following data formats. Data formats differ according to command numbers. A data area or sub command is added for some commands.

Controller to IC-7800

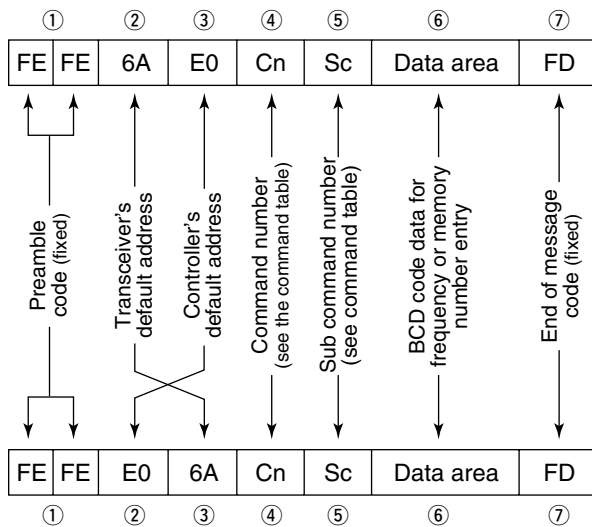

IC-7800 to controller

OK message to controller

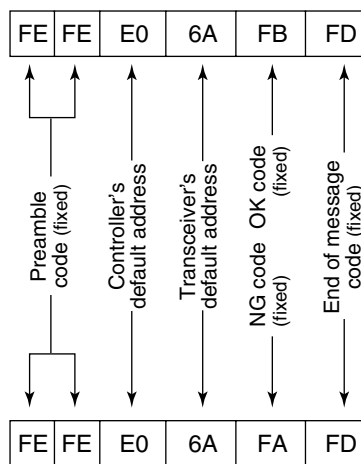

NG message to controller

◇ Command table

Command	Sub command	Description	Command	Sub command	Description
00	—	Send frequency data	11	—	Select/read attenuator (0=OFF; 1=3 dB; 2=6 dB; 3=9 dB; 4=12 dB; 5=15 dB; 6=18 dB; 7=21 dB)
01	Same as command 06	Send mode data	12	00 + RX ANT	Select/read ANT1 selection (00=RX ANT OFF; 01=RX ANT ON)
02	—	Read band edge frequencies		01 + RX ANT	Select/read ANT2 selection (00=RX ANT OFF; 01=RX ANT ON)
03	—	Read operating frequency		02 + RX ANT	Select/read ANT3 selection (00=RX ANT OFF; 01=RX ANT ON)
04	—	Read operating mode		03 + RX ANT	Select/read ANT4 selection (00=RX ANT OFF; 01=RX ANT ON)
05	—	Set operating frequency	13	00	Announce with voice synthesizer (00=all data; 01=frequency and S-meter level; 02=receive mode)
06	00	Select LSB		01	
	01	Select USB		02	
	02	Select AM	14	01 + Level data	[AF] level setting (0=max. CCW to 255=max. CW)
	03	Select CW		02 + Level data	[RF] level setting (0=max. CCW to 255=11 o'clock)
	04	Select RTTY		03 + Level data	[SQL] level setting (0=11 o'clock to 255=max. CW)
	05	Select FM		05 + Level data	[APF] level setting (0=Pitch-550 Hz, 128=Pitch, 255=Pitch+550 Hz; 10 Hz steps)
	07	Select CW-R		06 + Level data	[NR] level setting (0=min. to 255=max.)
	08	Select RTTY-R		07 + Level data	Inside [TWIN PBT] setting or IF shift setting (0=max. CCW, 128=center, 255=max. CW)
12	Select PSK	08 + Level data		Outside [TWIN PBT] setting (0=max. CCW, 128=center, 255=max. CW)	
13	Select PSK-R	09 + Level data		[CW PITCH] setting (0=300 Hz, 128=600 Hz, 255=900 Hz; 5 Hz steps)	
07	—	Select VFO mode	0A + Level data	[RF POWER] setting (0=max. CCW to 255=max. CW)	
	B0	Exchange main and sub bands	0B + Level data	[MIC] setting (0=max. CCW to 255=max. CW)	
	B1	Equalize main and sub bands	0C + Level data	[KEY SPEED] setting (0=max. CCW to 255=max. CW)	
	C0	Turn the dualwatch OFF	0D + Level data	[NOTCH] setting (0=low freq. to 255=high freq.)	
	C1	Turn the dualwatch ON	0E + Level data	[COMP] setting (0=max. CCW to 255=max. CW)	
	D0	Select main band	0F + Level data	[DELAY] setting (0=max. CCW to 255=max. CW)	
	D1	Select sub band	11 + Level data	[AGC] control setting (0=max. CCW to 255=max. CW)	
08	—	Select memory mode	12 + Level data	[NB] control setting (0=max. CCW to 255=max. CW)	
	0001-0101*	Select memory channel *P1=0100, P2=0101	13 + Level data	[DIGI-SEL] setting (0=max. CCW to 255=max. CW)	
			14 + Level data	[DRIVE] setting (0=max. CCW to 255=max. CW)	
09	—	Memory write	15 + Level data	[MONI GAIN] setting (0=max. CCW to 255=max. CW)	
0A	—	Memory to VFO	16 + Level data	[VOX GAIN] setting (0=max. CCW to 255=max. CW)	
0B	—	Memory clear	17 + Level data	[ANTI VOX] setting (0=max. CCW to 255=max. CW)	
0E	00	Scan stop	18 + Level data	[CONTRAST] setting (0=max. CCW to 255=max. CW)	
	01	Programmed/memory scan start	19 + Level data	[BRIGHT] setting (0=max. CCW to 255=max. CW)	
	02	Programmed scan start			
	03	Δ F scan start			
	12	Fine programmed scan start			
	13	Fine Δ F scan start			
	22	Memory scan start			
	23	Select memory scan start			
	A1-A7	Set Δ F scan span (A1= \pm 5 kHz; A2= \pm 10 kHz; A3= \pm 20 kHz; A4= \pm 50 kHz; A5= \pm 100 kHz; A6= \pm 500 kHz; A7= \pm 1 MHz)			
	B0	Set as non-select channel			
	B1	Set as select channel (1= \star 1; 2= \star 2; 3= \star 3; when no data command is specified, the previously set number or " \star 1" is selected)			
B2	Set the number for select memory scan (0=ALL; 1= \star 1; 2= \star 2; 3= \star 3)				
D0	Set scan resume OFF				
D3	Set scan resume ON				
0F	00	Turn the split function OFF			
	01	Turn the split function ON			
10	00	Select 10 Hz (1 Hz) tuning step			
	01	Select 100 Hz tuning step			
	02	Select 1 kHz tuning step			
	03	Select 5 kHz tuning step			
	04	Select 9 kHz tuning step			
	05	Select 10 kHz tuning step			
	06	Select 12.5 kHz tuning step			
	07	Select 20 kHz tuning step			
	08	Select 25 kHz tuning step			

14 CONTROL COMMAND

◇ Command table (continued)

Command	Sub command	Description
15	01	Read squelch condition
	02	Read S-meter level
	11	Read RF power meter
	12	Read SWR meter
	13	Read ALC meter
	14	Read COMP meter
	15	Read V _D meter
	16	Read I _D meter
16	02	Preamp (0=OFF; 1=preamp 1; 2=preamp 2)
	12	AGC selection (0=OFF; 1=Slow; 2=Mid; 3=Fast)
	22	Noise blanker (0=OFF; 1=ON)
	32	Audio peak filter (0=OFF; 1=WIDE/320 Hz; 2=MID/160 Hz; 3=NAR/80 Hz)
	40	Noise reduction (0=OFF; 1=ON)
	41	Auto notch (0=OFF; 1=ON)
	42	Repeater tone (0=OFF; 1=ON)
	43	Tone squelch (0=OFF; 1=ON)
	44	Speech compressor (0=OFF; 1=ON)
	45	Monitor (0=OFF; 1=ON)
	46	VOX function (0=OFF; 1=ON)
	47	Break-in (0=OFF; 1=semi break-in; 2=full break-in)
	48	Manual notch (0=OFF; 1=ON)
	4C	VSC (0=OFF; 1=ON)
	4D	Manual AGC (0=OFF; 1=ON)
4E	DIGI-SEL (0=OFF; 1=ON)	
4F	Twin peak filter (0=OFF; 1=ON)	
50	Dial lock (0=OFF; 1=ON)	
19	00	Read the transceiver ID
1A	00	Send/read memory contents (see p. 14-9 for details)
	01	Send/read band stacking register contents (see p. 14-9 for details)
	02	Send/read memory keyer contents (see p. 14-9 for details)
	03	Send/read the selected filter width (SSB, CW, PSK: 0=50 Hz to 40=3600 Hz; RTTY: 0=50 Hz to 31=2700 Hz; AM: 0=200 Hz to 49=10 kHz)
	04	Send/read the selected AGC time constant (0=OFF, 1=0.1/0.3 sec. to 13=6.0/8.0 sec.)
	050001	Send/read SSB TX Tone (Bass) level (0=-5 to 10=+5)
	050002	Send/read SSB TX Tone (Treble) level (0=-5 to 10=+5)
	050003	Send/read SSB RX Tone (Bass) level (0=-5 to 10=+5)
	050004	Send/read SSB RX Tone (Treble) level (0=-5 to 10=+5)
	050005	Send/read AM TX Tone (Bass) level (0=-5 to 10=+5)
050006	Send/read AM TX Tone (Treble) level (0=-5 to 10=+5)	
050007	Send/read AM RX Tone (Bass) level (0=-5 to 10=+5)	
050008	Send/read AM RX Tone (Treble) level (0=-5 to 10=+5)	
050009	Send/read FM TX Tone (Bass) level (0=-5 to 10=+5)	

Command	Sub command	Description
1A	050010	Send/read FM TX Tone (Treble) level (0=-5 to 10=+5)
	050011	Send/read FM RX Tone (Bass) level (0=-5 to 10=+5)
	050012	Send/read FM RX Tone (Treble) level (0=-5 to 10=+5)
	050013	Send/read SSB TX bandwidth for wide (see p. 14-10 for details)
	050014	Send/read SSB TX bandwidth for mid. (see p. 14-10 for details)
	050015	Send/read SSB TX bandwidth for narrow (see p. 14-10 for details)
	050016	Send/read speech level (0=0% to 255=100%)
	050017	Send/read CW side tone gain (0=min. to 255=max.)
	050018	Send/read CW side tone gain limit (0=OFF, 1=ON)
	050019	Send/read beep gain (0=min. to 255=max.)
	050020	Send/read beep gain limit (0=OFF, 1=ON)
	050021	Send/read headphones output ratio (0=0.60 to 255=1.40)
	050022	Send/read headphone output selection (0=separated, 1=mixed)
	050023	Send/read AF/SQL signal output to ACC-A (0=Main; 1=Sub)
	050024	Send/read AF/SQL signal output to ACC-B (0=Main; 1=Sub)
	050025	Send/read AF output level to ACC-A (0=0% to 255=100%)
	050026	Send/read AF output level to ACC-B (0=0% to 255=100%)
	050027	Send/read S/P DIF output level (0=0% to 255=100%)
	050028	Send/read MOD output level to ACC-A (0=0% to 255=100%)
	050029	Send/read MOD output level to ACC-B (0=0% to 255=100%)
	050030	Send/read S/P DIF MOD output level (0=0% to 255=100%)
	050031	Send/read MOD input connector during DATA OFF (0=MIC; 1=ACC-A; 2=ACC-B; 3=MIC/ACC-A; 4=MIC/ACC-B; 5=ACC-A/ACC-B; 6=MIC/ACC-A/ACC-B; 7=S/P DIF)
	050032	Send/read MOD input connector during DATA1 (0=MIC; 1=ACC-A; 2=ACC-B; 3=MIC/ACC-A; 4=MIC/ACC-B; 5=ACC-A/ACC-B; 6=MIC/ACC-A/ACC-B; 7=S/P DIF)
	050033	Send/read MOD input connector during DATA2 (0=MIC; 1=ACC-A; 2=ACC-B; 3=MIC/ACC-A; 4=MIC/ACC-B; 5=ACC-A/ACC-B; 6=MIC/ACC-A/ACC-B; 7=S/P DIF)
	050034	Send/read MOD input connector during DATA3 (0=MIC; 1=ACC-A; 2=ACC-B; 3=MIC/ACC-A; 4=MIC/ACC-B; 5=ACC-A/ACC-B; 6=MIC/ACC-A/ACC-B; 7=S/P DIF)

◇ Command table (continued)

Command	Sub command	Description	Command	Sub command	Description	
1A	050035	Send/read the band selection for operating frequency band signal output to ACC-A. (0=MAIN, 1=SUB, 2=TX)	1A	050057	Send/read opening message indication (0=OFF, 1=ON)	
	050036	Send/read the band selection for operating frequency band signal output to ACC-A. (0=MAIN, 1=SUB, 2=TX)		050058	Send/read opening message contents (see p. 14-9 for details)	
	050037	Send/read relay type selection (0=Lead, 1=MOS-FET)		050059	Send/read date (20000101=1st Jan. 2001 to 20991231=31st Dec. 2099)	
	050038	Send/read main band's external meter output selection (0=Auto, 1=S (main), 2=Po, 3=SWR, 4=ALC, 5=COMP, 6=Vd, 7=Id)		050060	Send/read time (0000=00:00 to 2359=23:59)	
	050039	Send/read sub band's external meter output selection (0=Auto, 1=S (sub), 2=Po, 3=SWR, 4=ALC, 5=COMP, 6=Vd, 7=Id)		050061	Send/read clock 2 function (0=OFF, 1=ON)	
	050040	Send/read main band's external meter output level (0=0% to 255=100%)		050062	Send/read offset time for clock 2 (240001=-24:00 to 240000=+24:00)	
	050041	Send/read sub band's external meter output level (0=0% to 255=100%)		050063	Send/read clock 2 name (up to 3-character; see p. 14-9)	
	050042	Send/read reference signal in/out setting (0=OFF, 1=IN, 2=OUT)		050064	Send/read calibration marker (0=OFF, 1=ON)	
	050043	Send/read reference signal frequency setting (0=0% to 255=100%)		050065	Send/read confirmation beep (0=OFF, 1=ON)	
	050044	Send/read LCD unit backlight brightness (0=0% to 255=100%)		050066	Send/read band edge beep (0=OFF, 1=ON)	
	050045	Send/read switch indicator brightness (0=0% to 255=100%)		050067	Send/read main band's beep audio frequency (50=500 Hz to 200=2000 Hz)	
	050046	Send/read screen image type (0=A, 1=B, 2=C)		050068	Send/read sub band's beep audio frequency (50=500 Hz to 200=2000 Hz)	
	050047	Send/read frequency readout font (0=Italic (1), 1=Italic (2), 2=Italic (3), 3=Italic (4), 4=Round (1), 5=Round (2), 6=Round (3), 7=Shadow (1), 8=Shadow (2), 9=Shadow (3), 10=Qubic (1), 11=Qubic (2), 12=Qubic (3), 13=Qubic (4), 14=IC-780 (1), 15=IC-780 (2), 16=IC-780 (3), 17=IC-780 (4))		050069	Send/read quick dualwatch function (0=OFF, 1=ON)	
	050048	Send/read font for other than frequency readout (0=Normal, 1=Slim)		050070	Send/read quick split set (0=OFF, 1=ON)	
	050049	Send/read meter type (0=Standard, 1=Edgewise, 2=Bar)		050071	Send/read FM split offset -9.999 to +9.999 MHz for HF (see p. 14-10 for details)	
	050050	Send/read meter type during wide screen or mini scope indication (0=Edgewise, 1=Bar)		050072	Send/read FM split offset -9.999 to +9.999 MHz for 50 MHz (see p. 14-10 for details)	
	050051	Send/read peak hold set (0=OFF, 1=ON)		050073	Send/read split lock set (0=OFF, 1=ON)	
	050052	Send/read memory name indication setting (0=OFF, 1=ON)		050074	Send/read tuner auto start set (0=OFF, 1=ON)	
	050053	Send/read audio peak filter width pop-up indication setting (0=OFF, 1=ON)		050075	Send/read PTT tune set (0=OFF, 1=ON)	
	050054	Send/read manual notch width pop-up indication setting (0=OFF, 1=ON)		050076	Send/read transverter set (0=OFF, 1=ON)	
	050055	Send/read output signal setting for external display (0=OFF, 1=ON)		050077	Send/read transverter offset (see p. 14-10 for details)	
	050056	Send/read synchronous pulse level setting (0=L, 1=H)		050078	Send/read RTTY mark frequency (0=1275 Hz, 1=1615 Hz, 2=2125 Hz)	
					050079	Send/read RTTY shift width (0=170 Hz, 1=200 Hz, 2=425 Hz)
					050080	Send/read RTTY keying polarity (0=Normal, 1=Reverse)
					050081	Send/read PSK tone frequency (0=1000 Hz, 1=1500 Hz, 2=2000 Hz)
					050082	Send/read speech language (0=English, 1=Japanese)
			050083	Send/read speech speed (0=Slow, 1=Fast)		
			050084	Send/read S-level speech (0=OFF, 1=ON)		
			050085	Send/read speech with a mode switch operation (0=OFF, 1=ON)		
			050086	Send/read memo pad numbers (0=5 ch, 1=10 ch)		

◇ Command table (continued)

Command	Sub command	Description
1A	050087	Send/read main dial function (0=MAIN, 1=MAIN+SUB)
	050088	Send/read main dial auto TS (0=OFF, 1=Low, 2=High)
	050089	Send/read sub dial auto TS (0=OFF, 1=Low, 2=High)
	050090	Send/read mic. up/down speed (0=Low, 1=High)
	050091	Send/read quick RIT/ Δ TX clear function (0=OFF, 1=ON)
	050092	Send/read SSB notch operation (0=Auto, 1=Manual, 2=Auto/Manual)
	050093	Send/read AM notch operation (0=Auto, 1=Manual, 2=Auto/Manual)
	050094	Send/read DIGI-SEL control function (0=DIGI-SEL, 1=APF)
	050095	Send/read band indication for filter set screen (0=Fix, 1=Auto)
	050096	Send/read SSB/CW synchronous tuning function (0=OFF, 1=ON)
	050097	Send/read CW normal side set (0=LSB, 1=USB)
	050098	Send/read band setting for audio output from mic. connector (0=MAIN+SUB, 1=SUB)
	050099	Send/read external keypad set for voice memory (0=OFF, 1=ON)
	050100	Send/read external keypad set for keyer memory (0=OFF, 1=ON)
	050101	Send/read CI-V transceive set (0=OFF, 1=ON)
	050102	Send/read RS-232C function (0=CI-V, 1=Decode)
	050103	Send/read RS-232C decode speed (0=300, 1=1200, 2=4800, 3=9600, 4=19200)
	050104	Send/read keyboard type (00=English, 01=Japanese, 02=United Kingdom, 03=French, 04=French (Canadian), 05=German, 06=Portuguese, 07=Portuguese (Brazilian), 08=Spanish, 09=Spanish (Latin American), 10=Italian)
	050105	Send/read keyboard repeat delay (10=100 msec. to 100=1000 msec.)
	050106	Send/read keyboard repeat speed (0=2.0 cps to 31=30.0 cps)
	050107	Send/read IP address set (0000000000000000=0.0.0.0 to 0255025502550255=255.255.255.255)
050108	Send/read subnet mask (0=0.0.0.0 to 30=255.255.255.252)	
050109	Send/read scope indication during TX (0=OFF, 1=ON)	
050110	Send/read scope max. hold (0=OFF, 1=ON)	
050111	Send/read scope center frequency set (0=Filter center, 1=Carrier point center, 2=Carrier point center (Abs. Freq.))	

Command	Sub command	Description
1A	050112	Send/read waveform color for receiving signal (see p. 14-10 for details)
	050113	Send/read waveform color for max. hold (see p. 14-10 for details)
	050114	Send/read scope sweep speed for ± 2.5 kHz span (0=Slow, 1=Mid., 2=Fast)
	050115	Send/read scope sweep speed for ± 5 kHz span (0=Slow, 1=Mid., 2=Fast)
	050116	Send/read scope sweep speed for ± 10 kHz span (0=Slow, 1=Mid., 2=Fast)
	050117	Send/read scope sweep speed for ± 25 kHz span (0=Slow, 1=Mid., 2=Fast)
	050118	Send/read scope sweep speed for ± 50 kHz span (0=Slow, 1=Mid., 2=Fast)
	050119	Send/read scope sweep speed for ± 100 kHz span (0=Slow, 1=Mid., 2=Fast)
	050120	Send/read scope sweep speed for ± 250 kHz span (0=Slow, 1=Mid., 2=Fast)
	050121	Send/read scope edge frequencies for 0.03 to 1.60 MHz band (see p. 14-10 for details)
	050122	Send/read scope edge frequencies for 1.60 to 2.00 MHz band (see p. 14-10 for details)
	050123	Send/read scope edge frequencies for 2.00 to 6.00 MHz band (see p. 14-10 for details)
	050124	Send/read scope edge frequencies for 6.00 to 8.00 MHz band (see p. 14-10 for details)
	050125	Send/read scope edge frequencies for 8.00 to 11.00 MHz band (see p. 14-10 for details)
	050126	Send/read scope edge frequencies for 11.00 to 15.00 MHz band (see p. 14-10 for details)
050127	Send/read scope edge frequencies for 15.00 to 20.00 MHz band (see p. 14-10 for details)	
050128	Send/read scope edge frequencies for 20.00 to 22.00 MHz band (see p. 14-10 for details)	
050129	Send/read scope edge frequencies for 22.00 to 26.00 MHz band (see p. 14-10 for details)	
050130	Send/read scope edge frequencies for 26.00 to 30.00 MHz band (see p. 14-10 for details)	
050131	Send/read scope edge frequencies for 30.00 to 45.00 MHz band (see p. 14-10 for details)	
050132	Send/read scope edge frequencies for 45.00 to 60.00 MHz band (see p. 14-10 for details)	
050133	Send/read auto voice monitor set (0=OFF, 1=ON)	

◇ Command table (continued)

Command	Sub command	Description	Command	Sub command	Description
1A	050134	Send/read voice memory short play time (3=3 sec. to 10=10 sec.)	1A	050164	Send/read scan speed (0=Low, 1=High)
	050135	Send/read voice memory normal record time (5= 5 sec. to 15=15 sec.)		050165	Send/read scan resume (0=OFF, 1=ON)
	050136	Send/read contest number style (0=Normal, 1=190→ANO, 2=190→ANT, 3=90→NO, 4=90→NT)		050166	Send/read antenna selection for 0.03 to 1.60 MHz band (see p. 14-10 for details)
	050137	Send/read count up trigger channel (1=M1, 2=M2, 3=M3, 4=M4)		050167	Send/read antenna selection for 1.60 to 2.00 MHz band (see p. 14-10 for details)
	050138	Send/read present number (1-9999)		050168	Send/read antenna selection for 2.00 to 6.00 MHz band (see p. 14-10 for details)
	050139	Send/read CW keyer repeat time (1=1 sec. to 60=60 sec.)		050169	Send/read antenna selection for 6.00 to 8.00 MHz band (see p. 14-10 for details)
	050140	Send/read CW keyer dot/dash ratio (28=1:1:2.8 to 45=1:1:4.5)		050170	Send/read antenna selection for 8.00 to 11.00 MHz band (see p. 14-10 for details)
	050141	Send/read rise time (0=2 msec., 1=4 msec., 2=6 msec., 3=8 msec.)		050171	Send/read antenna selection for 11.00 to 15.00 MHz band (see p. 14-10 for details)
	050142	Send/read paddle polarity (0=Normal, 1=Reverse)		050172	Send/read antenna selection for 15.00 to 20.00 MHz band (see p. 14-10 for details)
	050143	Send/read keyer type (0=Straight, 1=Bug-key, 2=ELEC-Key)		050173	Send/read antenna selection for 20.00 to 22.00 MHz band (see p. 14-10 for details)
	050144	Send/read mic. up/down keyer set (0=OFF, 1=ON)		050174	Send/read antenna selection for 22.00 to 26.00 MHz band (see p. 14-10 for details)
	050145	Send/read RTTY decode USOS (0=OFF, 1=ON)		050175	Send/read antenna selection for 26.00 to 30.00 MHz band (see p. 14-10 for details)
	050146	Send/read RTTY decode new line code (0=CR,LF,CR+LF, 1=CR+LF)		050176	Send/read antenna selection for 30.00 to 45.00 MHz band (see p. 14-10 for details)
	050147	Send/read RTTY diddle (0=OFF, 1=Blank, 2=Letter)		050177	Send/read antenna selection for 45.00 to 60.00 MHz band (see p. 14-10 for details)
	050148	Send/read RTTY TX USOS (0=OFF, 1=ON)		050178	Send/read antenna temporary memory set (0=OFF, 1=ON)
	050149	Send/read RTTY auto CR+LF by TX (0=OFF, 1=ON)		050179	Send/read antenna selection (0=OFF, 1=Manual, 2=Auto)
	050150	Send/read RTTY time stamp set (0=OFF, 1=ON)		050180	Send/read usage for ANT2 (0=OFF, 1=TX/RX)
	050151	Send/read clock selection for time stamp (0=Local time, 1=Clock 2)		050181	Send/read usage for ANT3 (0=OFF, 1=TX/RX)
	050152	Send/read frequency stamp (0=OFF, 1=ON)		050182	Send/read usage for ANT4 (0=OFF, 1=TX/RX, 2= RX)
	050153	Send/read received text font color (see p. 14-10 for details)		050183	Send/read VOX delay (0=0.0 sec. to 20=2.0 sec.)
	050154	Send/read transmitted text font color (see p. 14-10 for details)		050184	Send/read VOX voice delay (0=OFF, 1=Short, 2=Long)
	050155	Send/read time stamp text font color (see p. 14-10 for details)		050185	Send/read NB depth (0=1 to 9=10)
	050156	Send/read text font color in TX buffer (see p. 14-10 for details)		050186	Send/read NB width (0=0 to 255=255)
	050157	Send/read PSK time stamp set (0=OFF, 1=ON)		050187	Send/read screen saver set (0=OFF, 1=15 min., 2=30 min., 3=60 min.)
	050158	Send/read clock selection for time stamp (0=Local time, 1=Clock 2)		050188	Set/read screen saver type (0=Bound, 1=Rotation, 2=Twist)
	050159	Send/read frequency stamp (0=OFF, 1=ON)		050189	Set/read meter response setting (0=SLOW, 1=MID, 2=FAST)
	050160	Send/read received text font color (see p. 14-10 for details)			
	050161	Send/read transmitted text font color (see p. 14-10 for details)			
	050162	Send/read time stamp text font color (see p. 14-10 for details)			
	050163	Send/read text font color in TX buffer (see p. 14-10 for details)			

14 CONTROL COMMAND

◇ Command table (continued)

Command	Sub command	Description
1A	050190	Set/read FFT scope averaging set for RTTY decoder (0=OFF, 1=2, 2=3, 3=4)
	050191	Set/read FFT scope waveform color set for RTTY decoder (see p. 14-10 for details)
	050192	Set/read FFT scope averaging set for PSK decoder (0=OFF, 1=2, 2=3, 3=4)
	050193	Set/read FFT scope waveform color set for PSK decoder (see p. 14-10 for details)
	050194	Set/read PSK AFC function tuning range (0=±8 Hz, 1=±15 Hz)
	050195	Set/read APF type (0=SOFT, 1=SHARP)
	06	Send/read DATA mode with filter set (see p. 14-10 for detail)
	07	Send/read SSB transmit bandwidth (0=WIDE, 1=MID, 2=NAR)
	08	Send/read DSP filter shape (0= sharp, 1= soft)
	09	Send/read roofing filter set (0=3 kHz, 1=6 kHz, 2=15 kHz)
0A	Send/read manual notch width (0=Wide, 1=Mid., 2=Nar.)	
10	Send/read lock function set (0=OFF, 1=ON)	
1B	00	Set/read repeater tone frequency (see p. 14-10 for details)
	01	Set/read TSQL tone frequency (see p. 14-10 for details)
1C	00	Set/read the transceiver's condition (0=Rx; 1=Tx)
	01	Set/read antenna tuner condition (0=OFF, 1=ON, 2=Start tuning or while tuning)

◇ To send/read memory contents

When sending or reading memory contents, additional code must be added to appoint the memory channel as follows.

➔ Additional code: 0000–0101 (0100=P1, 0101=P2)

◇ Band stacking register

To send or read the desired band stacking register's contents, combined codes of the frequency band and register codes as follows are used.

For example, when sending/reading the oldest contents in the 21 MHz band, the code "0703" is used.

• Frequency band code

Code	Frequency band	Frequency range (unit: MHz)
01	1.8	1.800000– 1.999999
02	3.5	3.400000– 4.099999
03	7	6.900000– 7.499999
04	10	9.900000–10.499999
05	14	13.900000–14.499999
06	18	17.900000–18.499999
07	21	20.900000–21.499999
08	24	24.400000–25.099999
09	28	28.000000–29.999999
10	50	50.000000–54.000000
12	GENE	Other than above

• Register code

Code	Registered number
01	1 (latest)
02	2
03	3 (oldest)

◇ Codes for memory keyer contents

To send or read the desired memory keyer contents, the channel and character codes as follows are used.

• Channel code

Code	Channel number
01	M1
02	M2
03	M3
04	M4

• Character's code

Character	ASCII code	Description
0–9	30–39	Numerals
A–Z	41–5A	Alphabetical characters
space	20	Word space
/	2F	Symbol
?	3F	Symbol
,	2C	Symbol
.	2E	Symbol
^	5E	e.g., to send \bar{B} , enter ^4254
*	2A	Inserts contest number (can be used for 1 channel only)

◇ Codes for memory name, opening message and clock 2 name contents

To send or read the desired memory name settings, the character codes, instructed codes for memory keyer contents as above, and follows are additionally used.

• Character's code— Alphabetical characters

Character	ASCII code	Character	ASCII code
a–z	61–7A	—	—

• Character's code— Symbols

Character	ASCII code	Character	ASCII code
!	21	#	23
\$	24	%	25
&	26	¥	5C
?	3F	"	22
'	27	`	60
+	2B	–	2D
:	3A	;	3B
=	3D	<	3C
>	3E	(28
)	29	[5B
]	5D	{	7B
}	7D		7C
_	5F	–	7E
@	40		

■ Specifications	15-2
◇ General	15-2
◇ Transmitter	15-2
◇ Receiver	15-3
◇ Antenna tuner	15-3
■ Options	15-4

■ Specifications

◇ General

- **Frequency coverage** (unit: MHz) :
 - Receiver 0.030000–60.000000*¹
 - Transmitter 1.800000–1.999999*², 3.500000–3.999999*²,
5.330500*³, 5.346500*³, 5.366500*³, 5.371500*³,
5.403500*³, 7.000000–7.300000*²,
10.100000–10.150000*², 14.000000–14.350000*²,
18.068000–18.168000*², 21.000000–21.450000*²,
24.890000–24.990000*², 28.000000–29.700000*²,
50.000000–54.000000*²
- *¹Some frequency ranges are not guaranteed.
- *²Depending on versions. *³USA version only.
- **Operating mode** : USB, LSB, CW, RTTY, PSK31, AM, FM
- **Number of memory channels** : 101 (99 regular, 2 scan edges)
- **Antenna connector** : SO-239×4 (antenna impedance: 50 Ω)
- **Operating temperature range** : 0°C to +50°C; +32°F to +122°F
- **Frequency stability** : Less than ±0.05 ppm (approx. 5 min. after from turn
the main power, [I/O], ON, 0–50°C; 32–122°F)
- **Frequency resolution** : 1 Hz
- **Power supply requirement** : 85–265 V AC (universal input)
- **Power consumption** :
 - Power OFF Stand-by 10 VA typical
 - Receive Stand-by 200 VA typical
 - Max. audio 210 VA typical
 - Transmit at 200 W 800 VA
- **Dimensions** (projections not included) : 424×149×435 mm; 16¹¹/₁₆×5⁷/₈×17³/₁₆ in
- **Weight** : Approx. 25 kg; 55 lb
- **ACC 1 connectors** : 8-pin DIN connector×2
- **ACC 2 connectors** : 7-pin DIN connector×2
- **Display*** : 7-inch (diagonal) TFT color LCD (800×480)
- **EXT-DISPLAY connector** : D-sub 15S
- **CI-V connector** : 2-conductor 3.5 (d) mm (1/8")
- **RS-232C connector** : D-sub 9-pin
- **KEYBOARD connector** : USB

◇ Transmitter

- **Transmit output power** :
 - SSB, CW, RTTY, PSK31, FM 5–200 W
 - AM 5–50 W
 - 137 kHz band More than –20 dBm (Except for USA and Korean versions)
- **Modulation system** :
 - SSB P.S.N. modulation
 - AM Low power modulation
 - FM Phase modulation
- **Spurious emission** :
 - More than 60 dB (HF bands)
 - More than 70 dB (50 MHz band)
- **Carrier suppression** :
 - More than 63 dB (HF bands)
 - More than 73 dB (50 MHz band)
- **Unwanted side-band suppression** : More than 80 dB
- **ΔTX variable range** : ±9.999 kHz
- **Microphone connector** : 8-pin connector (600 Ω)
- **ELEC-KEY connector** : 3-conductor 6.35 (d) mm (1/4")
- **KEY connector** : 3-conductor 6.35 (d) mm (1/4")
- **RELAY connector** : Phono (RCA)
- **ALC connector** : Phono (RCA)

◇ Receiver

- **Receive system** : Double conversion superheterodyne system
- **Intermediate frequencies** :
 - 1st 64.455 MHz (MAIN band)
 - 64.555 MHz (SUB band)
 - 2nd 36 kHz
- **Sensitivity** :
 - SSB, CW, RTTY (BW=2.4 kHz, 10 dB S/N)
 - 0.100–1.799 MHz 0.5 μ V (pre-amp 1 ON)
 - 1.800–29.990 MHz 0.16 μ V (pre-amp 1 ON)
 - 50.000–54.000 MHz 0.13 μ V (pre-amp 2 ON)
 - AM (BW=6 kHz, 10 dB S/N)
 - 0.100–1.799 MHz 6.3 μ V (pre-amp 1 ON)
 - 1.800–29.990 MHz 2 μ V (pre-amp 1 ON)
 - 50.000–54.000 MHz 1 μ V (pre-amp 2 ON)
 - FM (BW=15 kHz, 12 dB SINAD)
 - 28.000–29.990 MHz 0.5 μ V (pre-amp 1 ON)
 - 50.000–54.000 MHz 0.32 μ V (pre-amp 2 ON)
- **Selectivity** :
 - SSB, RTTY (BW=2.4 kHz)
 - More than 2.4 kHz/–3 dB
 - Less than 3.6 kHz/–60 dB
 - CW (BW=500 Hz)
 - More than 500 Hz/–3 dB
 - Less than 700 Hz/–60 dB
 - AM (BW=6 kHz)
 - More than 6.0 kHz/–3 dB
 - Less than 15.0 kHz/–60 dB
 - FM (BW=15 kHz)
 - More than 12.0 kHz/–3 dB
 - Less than 20.0 kHz/–60 dB
- **Spurious and image rejection ratio** : More than 70 dB (except IF through on 50 MHz band)
- **Squelch sensitivity** :
 - SSB, CW, RTTY, PSK31 Less than 5.6 μ V
 - FM Less than 1 μ V
- **RIT variable range** : \pm 9.999 kHz
- **Audio output power** : More than 2.6 W at 10% distortion with an 8 Ω load
- **PHONES connector** : 3-conductor 6.35 (d) mm (1/4")
- **EXT-SP connectors** : 2-conductor 3.5 (d) mm (1/8")/8 Ω ×2 (for main and sub)

◇ Antenna tuner

- **Matching impedance range** : 16.7 to 150 Ω unbalanced
(HF bands; VSWR better than 3:1)
20 to 125 Ω unbalanced
(50 MHz band; VSWR better than 2.5:1)
- **Minimum operating input** : 8 W (HF bands)
15 W (50 MHz band)
- **Tuning accuracy** : VSWR 1.5:1 or less
- **Insertion loss (after tuning)** : Less than 1.0 dB

*The LCD display may have cosmetic imperfections that appear as small or dark spots. This is not a malfunction or defect, but a normal characteristic of LCD displays.

Spurious signals may be received near the following frequencies. These are made in the internal circuit and does not indicate a transceiver malfunction.

- 0.150 MHz • 10.490 MHz

Spurious waveforms may be displayed on the spectrum scope screen regardless of the transceiver's condition (Tx or Rx). They are made in the scope circuit. This does not indicate a transceiver malfunction.

All stated specifications are typical and subject to change without notice or obligation.

Options

- **IC-PW1/EURO** HF/50 MHz ALL BAND 1 kW LINEAR AMPLIFIER



Full-duty-cycle 1 kW linear amplifier including an automatic antenna tuner. Has automatic tuning and band selection capability when used with an Icom transceiver. Full break-in (QSK) operation. The amplifier/power supply unit and the remote control unit are separate.

- **SM-20** DESKTOP MICROPHONE



Unidirectional, electret microphone for base station operation. Includes [UP]/[DOWN] switches and a low cut function.

- **CT-17** CI-V LEVEL CONVERTER



For remote transceiver control using a PC. You can change frequencies, operating mode, memory channels, etc. (software is not included)

- **SP-20** EXTERNAL SPEAKER



4 audio filters; headphone jack; can connect to 2 transceivers.

- Input impedance : 8 Ω
- Max. input power : 5 W

- **HM-36** HAND MICROPHONE



Hand microphone equipped with [UP]/[DOWN] switches.

- General 16-2
- Caution 16-2
- Preparation 16-3
 - ◇ Firmware and firm utility 16-3
 - ◇ File downloading 16-3
- Firmware update— CF memory card 16-4
- Firmware update— PC 16-6
 - ◇ Connections 16-6
 - ◇ IP address setting 16-7
 - ◇ Updating from the PC 16-8

■ General

A memory card reader is required to copy the downloaded firmware file.

An Ethernet card/board (10 BASE-T/100 BASE TX compatible) is required when updating the firmware from the PC.

Both memory card reader and Ethernet card/board are not supplied from Icom.

Ask your PC dealer about a memory card reader and an Ethernet card/board for details.

The IC-7800's firmware can be updated if desired. By updating the firmware, new function(s) can be added and the improvement of performance parameters can be made.

2 ways of firmware update are available; one is using the CF memory card, and the other is using a PC.

You can choose either way according to your PC condition.

- When only one PC that is connected to internet is available
 - ➔ Refer to ■ Preparation (p. 16-3) and ■ Firmware update— CF memory card (p. 16-4)
- When two or more PCs that are connected to internet are available and they are connected to the LAN (Local Area Network)
 - ➔ Refer to ■ Preparation (p. 16-3) and either ■ Firmware update— PC (p. 16-6) or ■ Firmware update— CF memory card (p. 16-4)

Ask your dealer or distributor about how to update the firmware if you have no PC.

■ Caution

⚠ **CAUTION!:** NEVER turn the transceiver power OFF while updating the firmware.

You can turn the transceiver power OFF only when the transceiver displays that rebooting is required.

If you turn the transceiver power OFF, or if a power failure occurs during updating, the transceiver firmware will be damaged and you have to send the transceiver back to the nearest Icom distributor for repair. This type of repair is out of warranty even if the warranty period is still valid.

Recommendation!

Backing up the settings and/or memory contents to the CF memory card before starting the firmware update is recommended.

Settings and/or memory contents will be lost when the firmware update is performed.

■ Preparation

◇ Firmware and firm utility

The latest firmware and the firm utility can be downloaded from the Icom home page via the internet. Access the following URL to download the firm utility and the latest firmware.

<http://www.icom.co.jp/world/download/index.htm>

For updating from the CF memory card

When updating the firmware from the CF memory card, copy the downloaded firmware data (e.g. 7800_110.dat) to the CF memory card (in "IC-7800" folder) using a memory card reader (purchased separately from your PC dealer).

◇ File downloading

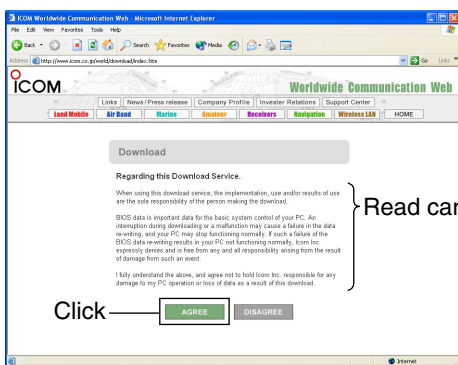

Read carefully

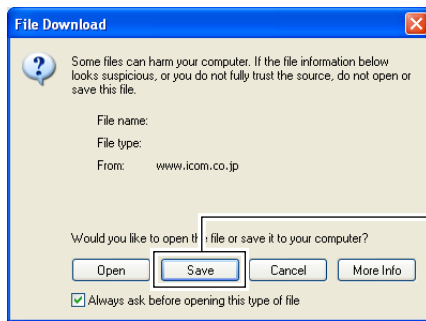

Click

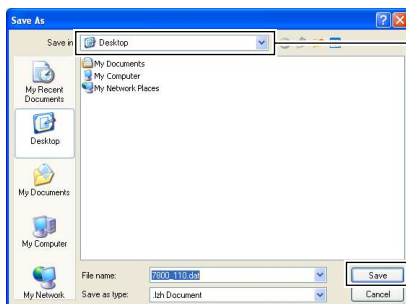

Select the saving location

Click

- ① Access the following URL directly.
<http://www.icom.co.jp/world/download/index.htm>
 - No link is available from the top page.
- ② Read "Regarding this Download Service" carefully, then click [AGREE].
- ③ Click "IC-7800" link then click the firmware file link.
- ④ Type your name, call sign, IC-7800's serial number, etc., then click [OK?].
- ⑤ Click [Save] in the displayed File Download dialog.
- ⑥ Select the desired location that you want to save the firmware to, then click [Save] in the displayed File Download dialog.
 - File download starts.
- ⑦ After download is completed, extract the file.
 - The firmware and the firm utility are compressed in "zip" format, respectively.
 - When updating the transceiver using with the CF memory card, copy the extracted firmware (e.g. 7800_110.dat) to the CF memory card IC-7800 folder.
 - The CF memory card must be formatted with the IC-7800.

■ Firmware update— CF memory card

When updating the firmware using with the CF memory card, no IP address as well as subnet mask settings are necessary.

- ① Copy the downloaded firmware data into the CF memory card (“IC-7800” folder).
 - The CF memory card must be formatted by the IC-7800.
- ② Insert the CF memory card into the CF card slot.
- ③ Push [EXIT/SET] several times to close a multi-function screen, if necessary.
- ④ Push [F-7•SET] to select set mode menu screen.
- ⑤ Push [F-7•CF CARD] to select CF card set menu.

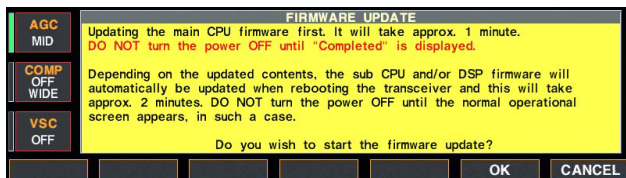
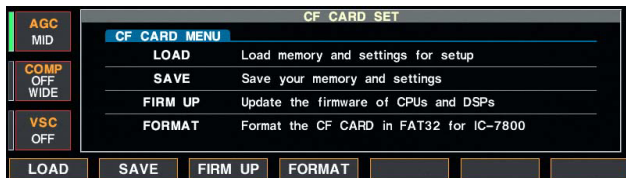
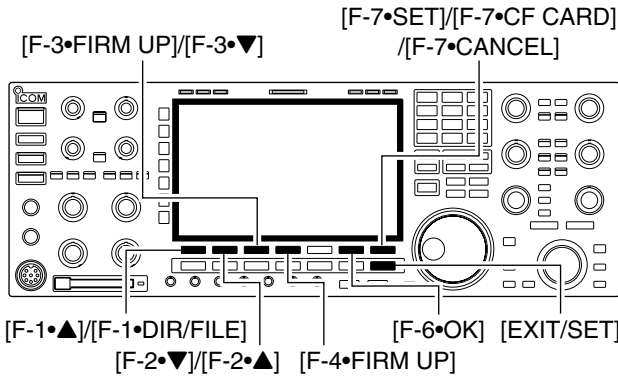

- ⑥ Push [F-3•FIRM UP] for 1 sec.
- ⑦ Read the displayed precaution carefully.
 - Push [F-1•▲] or [F-2•▼] to scroll the indication.
 - Push [F-7•CANCEL] to cancel the firmware updating.
- ⑧ After you read and agree to all of the precautions, push [F-6•OK].
 - [F-6•OK] appears only when the end of the precaution is displayed.
 - Push [F-7•CANCEL] to cancel the firmware updating.
- ⑨ Push [F-2•▲] or [F-3•▼] to select the firmware file, then push [F-4•FIRM UP].
- ⑩ Read the displayed precaution carefully.
- ⑪ If you agree, push [F-6•OK] for 1 sec. to start the firmware update.
 - Push [F-7•CANCEL] to cancel the firmware updating.
- ⑫ While loading the firmware from the CF memory card, the dialog as at left is displayed.

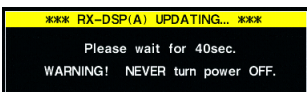
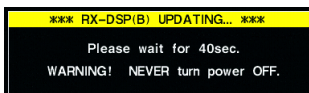
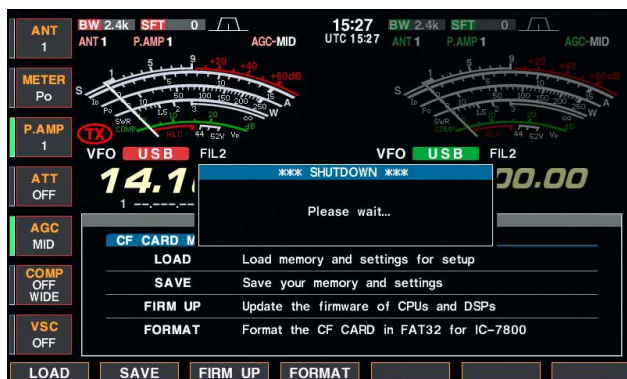
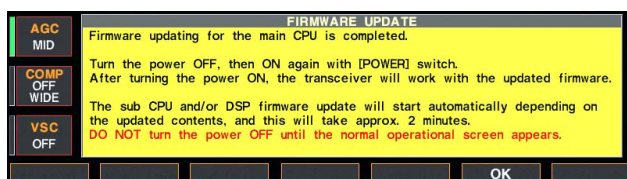
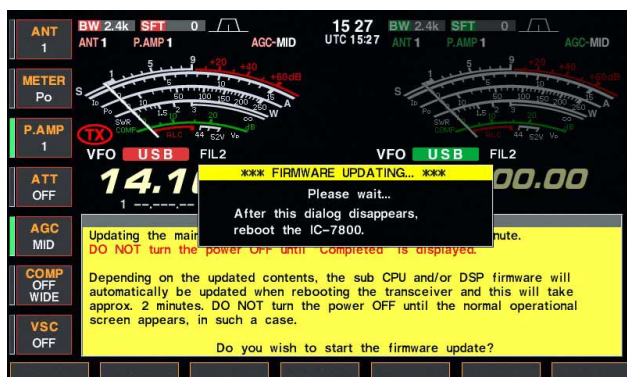

⑬ After the firmware loading is completed, the transceiver starts the update automatically and the dialog as at left is displayed.

⚠ **WARNING!** NEVER turn the IC-7800 power OFF at this stage.
 The transceiver firmware will be damaged.

⑭ When the dialog disappears, the precaution as at left is displayed.

⑮ Read the precaution carefully, and then push [F-6•OK].
 • Return to CF card set menu.

⑯ Push [POWER] to turn the IC-7800 power OFF, then ON again.

⑰ Depending on the updating, one to four dialog as at left appears in sequence.

⚠ **WARNING!** NEVER turn the IC-7800 power OFF at this stage.
 The transceiver firmware will be damaged.

⑱ After the dialog disappears, the firmware updating is completed and normal operation screen appears.

■ Firmware update— PC

◇ Connections

Connect the IC-7800 and the PC through a LAN (Local Area Network) as follows.

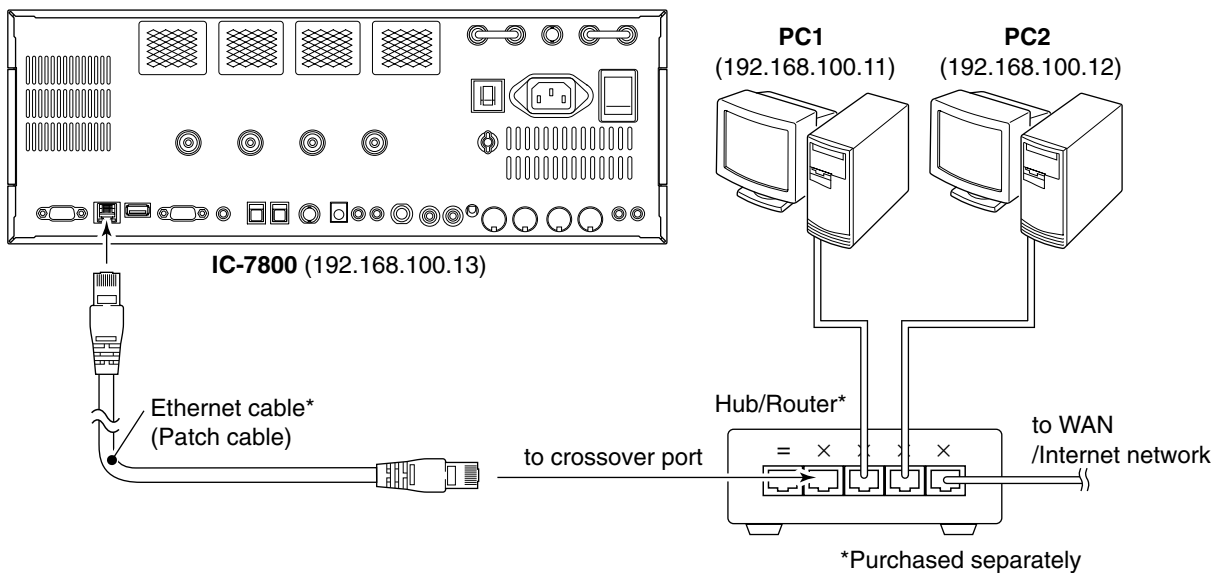

• IP address setting example

	PC1	PC2	IC-7800
IP address	192.168.100.11	192.168.100.12	192.168.100.13
Subnet mask	255.255.255.0	255.255.255.0	255.255.255.0

◇ IP address setting

When updating the firmware from the CF memory card, the following settings are not necessary.

IMPORTANT!: A fixed (static) IP address is used for the IC-7800.
 When you connect the IC-7800 to a LAN, ask the network manager about a usable/assignable IP address and the subnet mask in advance.
NEVER set the IP address that has already been used with another device in the network. If the IP address is duplicated, the network will crash down.

- ① Push [EXIT/SET] several times to close a multi-function screen, if necessary.
- ② Push [F-7•SET] to select set mode menu screen.
- ③ Push [F-5•OTHERS] to select miscellaneous (others) set mode.
- ④ Push [F-1•▲]/[F-2•▼] several times to select "IP Address" item.
- ⑤ Push [F-3•◀▶] to select the desired part then rotate main dial to set the desired or specified IP address.
 - "192.168.0.1" is the default setting.
- ⑥ Push [F-2•▼] to select "Subnet Mask" item.
- ⑦ Rotate main dial to set the desired or specified subnet mask.
 - "255.255.255.0" is the default setting.
- ⑧ Push [POWER] to turn the transceiver power OFF, then ON to effect the IP address and subnet mask settings.

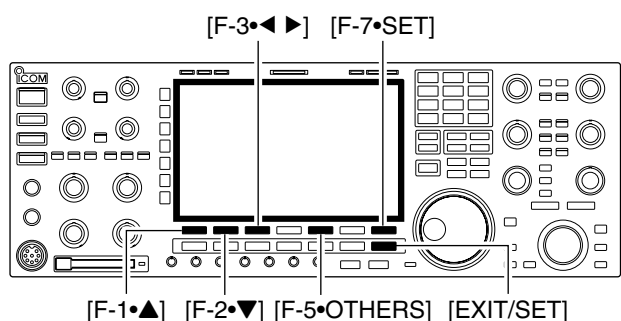

◇ Updating from the PC



- ① Start up the IC-7800 Firm Utility.
 - The window as at left appears.
- ② Read the caution in the window carefully.
- ③ Click [Yes] if you agree and continue the firmware updating.

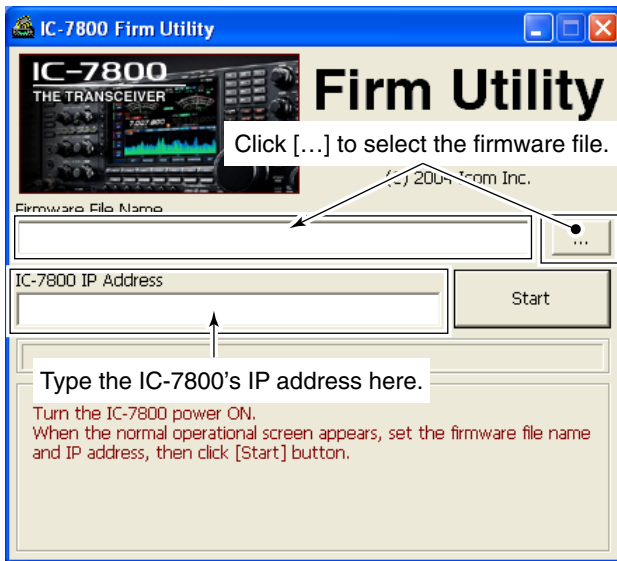

- ④ Select the firmware file, that has “dat” extension (e.g.: 7800_110.dat).
 - Click [...], then select the file, as well as the location.
- ⑤ Type the IC-7800’s IP address into “IC-7800 IP Address” text box.
- ⑥ Click [Start].



- ⑦ The window as at left appears.
 - Read the precaution in the window carefully.
- ⑧ Click [Yes] if you want to start the firmware update.



- ⑨ The screen as at left is displayed.
 - The following dialog appears in the IC-7800 display.

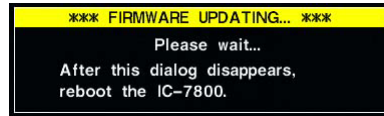

⚠ **WARNING!** NEVER turn the IC-7800 power OFF at this stage.
 The transceiver firmware will be damaged.

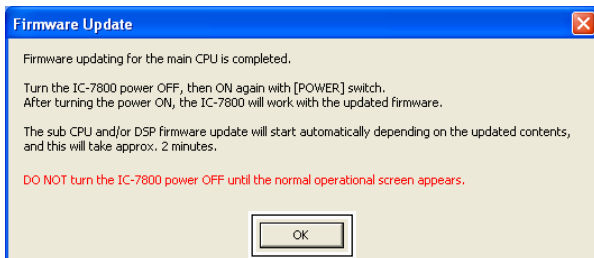

Click [OK] to finish the firmware update.

- ⑩ Click [OK] to finish the firmware update.
 - The “FIRMWARE UPDATING” dialog as above disappears.
- ⑪ Push [POWER] to turn the IC-7800 power OFF, then ON again.

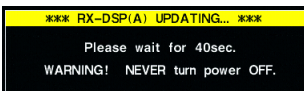
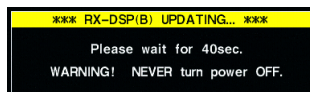

- ⑫ Depending on the updating, one to four dialogs as at left appears in the IC-7800 display in sequence.

⚠ **WARNING!** NEVER turn the IC-7800 power OFF at this stage.
 The transceiver firmware will be damaged.

- ⑬ After the dialog disappears, the firmware updating is completed and normal operation screen appears.

INSTALLATION NOTES

For amateur base station installations it is recommended that the forwards clearance in front of the antenna array is calculated relative to the EIRP (Effective Isotropic Radiated Power). The clearance height below the antenna array can be determined in most cases from the RF power at the antenna input terminals.

Different exposure limits have been recommended for different frequencies, a relative table shows a guideline for installation considerations.

Below 30 MHz, the recommended limits are specified in terms of V/m or A/m fields as they are likely to fall within the near-field region. Similarly, the antennas may be physically short in terms of electrical length and that the installation will require some antenna matching device which can create local, high intensity magnetic fields. Analysis of such installations is best considered in association with published guidance notes such as the FCC OET Bulletin 65 Edition 97-01 and its annexes relative to amateur transmitter installations. The EC recommended limits are almost identical to the FCC specified 'uncontrolled' limits and tables exist that show pre-calculated safe distances for different antenna types for different frequency bands. Further information can be found at <http://www.arrl.org/>.

• Typical amateur radio installation

Exposure distance assumes that the predominant radiation pattern is forward and that radiation vertically downward is at unity gain (sidelobe suppression is equal to main lobe gain). This is true of almost every gain antenna today. Exposed persons are assumed to be beneath the antenna array and have a typical height of 1.8 m.

The figures assume the worst-case emission of constant carrier.

For the bands 10 MHz and higher the following power density limits have been recommended:

10–144 MHz	2 W/sq m
------------	----------

EIRP clearance heights by frequency band

1 Watts	2.1 m
10 Watts	2.8 m
25 Watts	3.4 m
100 Watts	5 m
1000 Watts	12 m

Forward clearance, EIRP by frequency band

100 Watts	2 m
1000 Watts	6.5 m
10,000 Watts	20 m
100,000 Watts	65 m

In all cases any possible risk depends on the transmitter being activated for long periods. (actual recommendation limits are specified as an average during 6 minutes) Normally the transmitter is not active for long periods of time. Some radio licenses will require that a timer circuit automatically cuts the transmitter after 1–2 minutes etc.

Similarly some types of emission, i.e., SSB, CW, AM etc. have a lower 'average' output power and the assessed risk is even lower.



Versions of the IC-7800 which display the "CE" symbol on the serial number seal, comply with the essential requirements of the European Radio and Telecommunication Terminal Directive 1999/5/EC.



This warning symbol indicates that this equipment operates in non-harmonised frequency bands and/or may be subject to licensing conditions in the country of use. Be sure to check that you have the correct version of this radio or the correct programming of this radio, to comply with national licensing requirement.



**DECLARATION
OF CONFORMITY**

We Icom Inc. Japan
1-1-32, Kamiminami, Hirano-ku
Osaka 547-0003, Japan

Declare on our sole responsibility that this equipment complies with the essential requirements of the Radio and Telecommunications Terminal Equipment Directive, 1999/5/EC, and that any applicable Essential Test Suite measurements have been performed.

Kind of equipment: HF/50 MHz ALL MODE TRANSCEIVER

Type-designation: IC-7800

Version (where applicable):

This compliance is based on conformity according to Annex III of the directive 1999/5/EC using the following harmonised standards:

- i) Article 3.1a EN 60950 + A11
- ii) Article 3.1b EN 301489-1 and EN 301489-15
- iii) Article 3.2 EN 301 783-2
- iv) _____
- v) _____



Düsseldorf 27th Feb. 2004
Place and date of issue

Icom (Europe) GmbH
Himmelgeister strasse 100
D-40225 Düsseldorf
Authorized representative name

T. Maebayashi
General Manager

Signature

Icom Inc.

Please record the serial number of your IC-7800 transceiver below for future servicing reference:

Serial Number : _____

Date of purchase : _____

Place where purchased : _____

Count on us!

IC-7800
#03 (Europe)

<Intended Country of Use>			
<input checked="" type="checkbox"/> GER	<input type="checkbox"/> FRA	<input type="checkbox"/> ESP	<input checked="" type="checkbox"/> SWE
<input checked="" type="checkbox"/> AUT	<input checked="" type="checkbox"/> NED	<input type="checkbox"/> POR	<input checked="" type="checkbox"/> DEN
<input type="checkbox"/> GBR	<input checked="" type="checkbox"/> BEL	<input type="checkbox"/> ITA	<input checked="" type="checkbox"/> FIN
<input checked="" type="checkbox"/> IRL	<input checked="" type="checkbox"/> LUX	<input checked="" type="checkbox"/> GRE	<input type="checkbox"/> SUI
<input type="checkbox"/> NOR			

IC-7800
#04 (France)

<Intended Country of Use>			
<input type="checkbox"/> GER	<input checked="" type="checkbox"/> FRA	<input type="checkbox"/> ESP	<input type="checkbox"/> SWE
<input type="checkbox"/> AUT	<input type="checkbox"/> NED	<input type="checkbox"/> POR	<input type="checkbox"/> DEN
<input type="checkbox"/> GBR	<input type="checkbox"/> BEL	<input type="checkbox"/> ITA	<input type="checkbox"/> FIN
<input type="checkbox"/> IRL	<input type="checkbox"/> LUX	<input type="checkbox"/> GRE	<input type="checkbox"/> SUI
<input type="checkbox"/> NOR			

IC-7800
#06 (Italy)

<Intended Country of Use>			
<input type="checkbox"/> GER	<input type="checkbox"/> FRA	<input type="checkbox"/> ESP	<input type="checkbox"/> SWE
<input type="checkbox"/> AUT	<input type="checkbox"/> NED	<input type="checkbox"/> POR	<input type="checkbox"/> DEN
<input type="checkbox"/> GBR	<input type="checkbox"/> BEL	<input checked="" type="checkbox"/> ITA	<input type="checkbox"/> FIN
<input type="checkbox"/> IRL	<input type="checkbox"/> LUX	<input type="checkbox"/> GRE	<input type="checkbox"/> SUI
<input type="checkbox"/> NOR			

IC-7800
#08 (Spain)

<Intended Country of Use>			
<input type="checkbox"/> GER	<input type="checkbox"/> FRA	<input checked="" type="checkbox"/> ESP	<input type="checkbox"/> SWE
<input type="checkbox"/> AUT	<input type="checkbox"/> NED	<input checked="" type="checkbox"/> POR	<input type="checkbox"/> DEN
<input type="checkbox"/> GBR	<input type="checkbox"/> BEL	<input type="checkbox"/> ITA	<input type="checkbox"/> FIN
<input type="checkbox"/> IRL	<input type="checkbox"/> LUX	<input type="checkbox"/> GRE	<input type="checkbox"/> SUI
<input type="checkbox"/> NOR			

IC-7800
#10 (United
Kingdom)

<Intended Country of Use>			
<input type="checkbox"/> GER	<input type="checkbox"/> FRA	<input type="checkbox"/> ESP	<input type="checkbox"/> SWE
<input type="checkbox"/> AUT	<input type="checkbox"/> NED	<input type="checkbox"/> POR	<input type="checkbox"/> DEN
<input checked="" type="checkbox"/> GBR	<input type="checkbox"/> BEL	<input type="checkbox"/> ITA	<input type="checkbox"/> FIN
<input type="checkbox"/> IRL	<input type="checkbox"/> LUX	<input type="checkbox"/> GRE	<input type="checkbox"/> SUI
<input type="checkbox"/> NOR			

Icom Inc.

1-1-32 Kamiminami, Hirano-ku, Osaka 547-0003, Japan